

East Riding Horticulture Ltd



**FAMILY BUSINESS
SINCE 1989**

HORTICULTURE PRODUCT GUIDE ISSUE 3

Welcome

We are pleased to present our new horticultural brochure designed to provide information and advice on the vast range of products that we either hold in stock or handle on a direct basis. Every effort has been made to include as many of our items as possible, however if you are unable to find what you are looking for, please contact our sales office or your local area sales representative.

About Us

East Riding Horticulture was formed in 1989 to act as a sundries merchant to the professional grower, landscaper, and groundsman. Since then, the company has steadily grown and established itself in all horticultural sectors including Turf & Amenity, Landscape & Forestry, Irrigation, and an expanding Festive range. Built on a family style business, we pride ourselves on offering good solid technical advice coupled with the right product at the right price.

Delivery

Where possible, deliveries are made by our own drivers using our own vehicles ranging from 7.5 tonne lorries to smaller vans and pickups. By running our own fleet we maintain greater control and flexibility over deliveries. For details of the postcodes we cover with this service visit www.eastridinghorticulture.co.uk

Minimum Order

A minimum order surcharge of £6.95 will be charged on all orders under £100. Carriage may be charged if your delivery address falls outside of our delivery network. Carriage maybe be added under other circumstances, such as next day delivery or direct delivery.

Contact

Tel: 01904 608157
Email: info@erh-ltd.co.uk
www.eastridinghorticulture.co.uk

Contact

Telephone:

01904 608 157

Email:

info@erh-ltd.co.uk

Website:

www.eastridinghorticulture.co.uk

Address:

York:

Glebe Farm Cottage, High Lane, Sutton Upon Derwent, York,
YO41 4BY

Scotland:

11 Humble Holdings, Kirknewton, Midlothian, EH27 8DS

Scotland Telephone: 01506 880090

Payment:

VAT:

All prices quoted by East Riding Horticulture exclude VAT.

Methods of Payment:

To keep your card details safe we only take card payments over the phone or by the Worldpay Portal on our invoices. Should you wish to settle your account by card we are happy to accept Mastercard and Visa cards.

Cheque:

All Cheques to be made payable to East Riding Horticulture Ltd

Account:

Customers wishing to open an account can request an application form on 01904 608157 or by email sales@erh-ltd.co.uk Terms are net 30 days.

Bank Details for BACs payments:

East Riding Horticulture Ltd
Account Number: 17060068
Sort Code: 30-12-86

Contents

4 - 17	Growing Media
18 - 24	Barks, Mulches & Compost Additives
25 - 51	Fertiliser & Liquid Feed
52 - 59	Chemical Controls & Spray Tank Additives
60	Shading Paint
61 - 62	Pest Control
63 - 66	Biological Control
67 - 76	Chemical Storage & Spraying Equipment
77 - 96	Irrigation
97 - 132	Pots & Trays
133 - 140	Hanging Baskets
141 - 156	Plant Labels & Grower Sundries

157 - 164	Tree Care
165 - 170	Landscaping
171 - 174	Decorative Aggregates
175 - 178	Transport & Handling
179 - 194	Hand Tools
195 - 205	Netting & Fabrics
206 - 211	Polythene
212 - 217	Environment Control
218 - 220	Packaging
221 - 227	Retail Products
228 - 229	Winter Products

Levington® Advance

Levington has been the go to supplier for growing media for over 50 years, not only because people trust the product to provide them with the best results, but also because of the constant research and development that goes into making sure Levington remains on top of its game.



Nursery Stock Compost

CNS General				
Levington CNS General is made up of a blend of 0-10mm and 6-12mm particles of peat. This allows it to flow readily into smaller pots yet retain a reasonable open structure for drainage.				
Code	pH Range	Nutrients Added	Particle Size	Bag Size
COMP-CONT/03	4.8-5.3	N90 P46 K150	40% 0-10mm 60% 6-12mm	75lt

CNS Ericaceous				
The structure of this growing media is based on CNS general as is the starter fertiliser. Designed for acid loving plants such as Heather, Rhododendrons, Camellia and Pieris.				
Code	pH Range	Nutrients Added	Particle Size	Bag Size
COMP-CONT/02	4.4-5.0	N180 P92 K299	40% 0-10mm 60% 6-12mm	75lt

Potting

Alpine, Herbaceous, and Cyclamen AHC				
A blend of 0-10mm and 6-12mm peat plus 5-12mm pine bark to keep the structure open. This product is well drained and has a low base fertiliser which provides a great growing medium for Alpine, Herbaceous and Cyclamen plants.				
Code	pH Range	Nutrients Added	Particle Size	Bag Size
COMP-ALP/02	4.8-5.5	N135 P60 K199	45% 0-10mm 35% 6-12mm 20% 5-12mm bark	75lt

Pot Plant General				
A blend of 0-10mm and 6-12mm particles providing a good open structure. To be used in small pots up to 2 litres, baskets and tubs.				
Code	pH Range	Nutrients Added	Particle Size	Bag Size
COMP-POTT/01	5.3-6.0	N144 P73 K239	40% 0-10mm 60% 6-12mm	75lt

Medium Course Potting				
Levington Medium Coarse Potting is a blend of particle sizes which produce an open structure for great quality drainage for both indoor and outdoor crops.				
Code	pH Range	Nutrients Added	Particle Size	Bag Size
COMP-POTT/08	5.3-6.0	N144 P73 K239	70% 0-10mm 30% 6-12mm	75lt

Growing Media

Potting & Bedding

Pot & Bedding M2				
Levington Pot & Bedding M2 is designed to grow a wide variety of bedding plants. M2 provides a good quality nutrient supply for feeding of up to four weeks.				
Code	pH Range	Nutrients Added	Particle Size	Bag Size
COMP-POTT/04	5.3-6.0	N192 P98 K319	0-10mm	75Lt



Seed & Modular

Seed & Modular F1				
A great low level nutrient compost which ensures the perfect start for young seedlings. Not only will it provide exceptional growth for even the most sensitive plants at this young age but also growers can take control of growth through water soluble feeding.				
Code	pH Range	Nutrients Added	Particle Size	Bag Size
COMP-SEED/01	5.3-6.0	N96 P49 K159	0-3mm	75Lt



Pot & Bedding M3				
Levington Pot & Bedding M3 is designed for the most vigorous plants including tomatoes. Its high nutrient content means that controlled release fertilisers are not required to be added to this product.				
Code	pH Range	Nutrients Added	Particle Size	Bag Size
COMP-POTT/05	5.3-6.0	N204 P104 K339	0-10mm	75Lt



Seed & Modular F2				
Levington Seed & Modular F2 is suitable for seed sowing and direct rooting of softwood cuttings like chrysanthemums and fuchsia. F2 is designed for more vigorous seedlings including vegetable plants.				
Code	pH Range	Nutrients Added	Particle Size	Bag Size
COMP-SEED/02	5.3-6.0	N144 P73 K239	0-3mm	75Lt



Seed & Modular F2S				
Levington Seed & Modular F2S is designed for seed sowing and direct rooting of cuttings. F2S contains silver sand which improves the flow of the growing media even into the smallest cells.				
Code	pH Range	Nutrients Added	Particle Size	Bag Size
COMP-SEED/03	5.3-6.0	N144 P73 K239	0-3mm	75Lt



Delivery Methods

How growers handle growing media depends on their equipment and of course personal preferences. With this in mind we offer a full range of options and delivery methods.

Why not ask about our Moffett Mounty options for delivery, at a small additional cost, providing you with peace of mind on delivery when placing your order.



- 75 litre bags
- Bulk bags in various sizes from 1.5m³ to 2.7m³
- Pro-bales containing up to 4.5m³
- Loose bulk up to 100m³
- Walking floor and artic tippers available

Propagation Compost

Modular Seed			
A free-flowing compost suitable for raising transplants, seed sowing and rooting cuttings.			
Code	pH Range	Nutrients Added	Bag Size
COMP-SEED/05	6	N96 P170 K249	75lt



Potting & Bedding Compost

All Purpose			
An easily managed general purpose peat-sand growing medium. Suitable for all year round propagating and raising of salad, vegetable, bedding and pot plants in pots, trays and packs.			
Code	pH Range	Nutrients Added	Bag Size
COMP-ALL	6	N192 P224 K384	75lt



Seed Sowing with Vermiculite			
A peat-vermiculite propagation mix for seed sowing and rooting cuttings.			
Code	pH Range	Nutrients Added	Bag Size
COMP-SEED/04	6	N144 P154 K264	75lt



Potting & Bedding			
For raising bedding and pot plants in pots, trays, hanging baskets and tubs.			
Code	pH Range	Nutrients Added	Bag Size
COMP-POTT/12	6	N192 P224 K384	75lt



Potting			
For raising bedding and pot plants in pots, trays, hanging baskets and tubs. Contains fine peat for enhanced nutrient content and moisture retention.			
Code	pH Range	Nutrients Added	Bag Size
COMP-POTT/09	6	N204 P238 K408	75lt

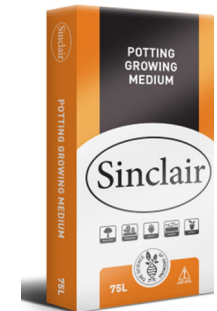

Growing Media

Medium Course Potting

A free-draining growing medium for pot bedding and pot plants.

Code	pH Range	Nutrients Added	Bag Size
COMP-POTT/11	6	N168 P196 K336	75Lt



Potting & Bedding with West + NS

for raising bedding and pot plants in pots, trays, hanging baskets and tubs. A superior peat reduced growing medium containing West+ technology which provides superior root establishment. Good water retention properties.

Code	pH Range	Nutrients Added	Bag Size
COMP-POTT/20	6	N180 P210 K360	75Lt



Primula & Pansy

A low-stress growing medium for an integrated approach to disease control. Reduced pH minimises the risk of iron chlorosis.

Code	pH Range	Nutrients Added	Bag Size
COMP-PRIM/05	5.5	N108 P198 K297	75Lt



Foremost Professional Multipurpose NS

Foremost Multi-Purpose Peat-based Compost is a superior grade of growing media ideal for potting on plug plants and houseplants, and for filling hanging baskets, troughs and patio planters for all-year-round displays.

Code	pH Range	Nutrients Added	Bag Size
COMP-MULTI/06	6	N168 P168 K216	75Lt



Call for more information on bulk bag and loose load sizes.

Tree Planting

Tree & Shrub			NS
A peat-based compost prepared from rich dark peat with high buffer capacity and high moisture retention for use when planting out into the ground.			
Code	pH Range	Nutrients Added	Bag Size
COMP-TREE/09	6	N168 P196 K336	75lt



Nursery Stock			
An easily managed coarse grade growing medium with bark and grit. Recommended for both ericaceous and non-ericaceous species.			
Code	pH Range	Nutrients Added	Bag Size
COMP-CONT/06	5	N120 P140 K140	75lt



Nursery Stock

Container			
Less coarse than Sinclair Nursery Stock Growing Medium and without grit. Recommended for both ericaceous and non-ericaceous species.			
Code	pH Range	Nutrients Added	Bag Size
COMP-CONT/08	5	N120 P140 K240	75lt



Alpine, Herbaceous & Cyclamen			
An easily managed peat-bark growing medium suitable for a wide range of alpine and herbaceous perennials. Not suitable for ericaceous species.			
Code	pH Range	Nutrients Added	Bag Size
COMP-ALP/01	6	N120 P140 K240	75lt



Nursery Stock Propagation			
A peat-bark-perlite growing medium which provides excellent rooting. Recommended for both ericaceous and non-ericaceous species.			
Code	pH Range	Nutrients Added	Bag Size
COMP-PROP/01	5	N60 P70 K120	75lt



Growing Media

Coir Compost

Coir Potting & Bedding			NS
Suitable for all year round raising of salad, vegetable, bedding and pot plants in trays, packs, pots, containers and hanging baskets. Not suitable for ericaceous species.			
Code	pH Range	Nutrients Added	Bag Size
COMP-COIR/01	6	N189 P192 K32	75lt



Coir Tray & Modular			NS
Suitable for seed raising and root cuttings. Mix is not suitable for ericaceous species. Excellent draining, no waterlogging.			
Code	pH Range	Nutrients Added	Bag Size
COMP-COIR/04	6	N158 P112 K192	75lt



Coir Growing Medium			NS
Suitable for use in growing media to individual requirements and as a soil conditioner. Can be added to growing media mixes to improve wettability and for peat reduction.			
Code	pH Range	Nutrients Added	Bag Size
COMP-COIR/05	6	None added	75lt



John Innes Compost

John Innes Composts

A range of loam based composts. loam based compost is heavier than other composts and gives container plants far greater stability.

- Classic John Innes formulation to support plants at every stage of growth
- Choose from Seed, No. 1, No. 2, No. 3 or JI Seed.
- Contains Scottish peat, sterilised loam and sand



Code	Product	Bag Size
COMP-JOHN/11	JAB John Innes No1	25lt
COMP-JOHN/12	JAB John Innes No2	25lt
COMP-JOHN/13	JAB John Innes No3	25lt
COMP-JOHN/08	JAB John Innes Seed	25lt

Growing Media

Clover Professional Products



Seed & Modular NS		
Fine grade peat, with low nutrient to control early growth. Contains wetting agent and 5% sand to ensure root contact and prevent capping. Suitable for seed sowing, plug trays, cuttings and general propagation.		
Code	Particle Range	Bag Size
COMP-SEED/11	0-6mm	80Lt



Container NS		
Medium to coarse grade peat, open structured with optional grit. Contains wetting agent and base nutrient with trace elements. Controlled release fertiliser and insecticides may be added to accommodate crop requirements. Suitable for nursery stock, shrubs and large pot plants.		
Code	Particle Range	Bag Size
COMP-CONT/01	0-25mm	80Lt



Pot/Bedding		
Fine to medium grade peat, with all the essential nutrients, trace elements and wetting agent. Suitable for tray bedding and small pots.		
Code	Particle Range	Bag Size
COMP-POTT/17	0-12mm	75Lt

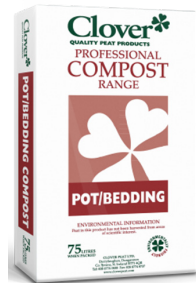

Herbaceous		
A medium grade peat with added grit and bark, suitable for a wide range of herbaceous perennials. Contains wetting agent and base nutrients. Controlled release fertilisers and insecticides are optional.		
Code	Particle Range	Bag Size
COMP-HERB/01	0-25mm	80Lt



Potting NS		
Medium grade peat, with high nutrient and open structure to increase drainage. Contains wetting agent and Clover unique NUTRICULT—a mineral based slow release fertiliser. Suitable for short and long term pot plants, baskets and containers.		
Code	Particle Range	Bag Size
COMP-POTT/18	0-15mm	75Lt



Ericaceous NS		
Medium to coarse grade peat, open structured with optional grit. Contains wetting agent and base nutrient with trace elements. Controlled release fertiliser and insecticides may be added to date crop requirements. Suitable for a wide range of lime hating species.		
Code	Particle Range	Bag Size
COMP-ERIC/01	0-12mm	80Lt



Klasmann Substrates

Bespoke mixes available. All mixes available in 70lt bags, big bales or loose.



Substrate 1			
Blend of white sphagnum peat and frozen through black sphagnum peat, water soluble fertiliser plus trace elements added. For bedding plant production in pots and packs as well as growing on of salt sensitive pot plants in small pots up to 9cm. Suitable also for direct sowing of herbs.			
Code	pH	Nutrients Added	Bag Size
COMP-POTT/13	6	N140 P100 K180	70lt



Container Substrate			
Blend of white sphagnum peat and frozen through black sphagnum peat, water soluble fertiliser plus trace elements added. For growing on trees, conifers and shrubs in 2lt containers and above.			
Code	pH	Nutrients Added	Bag Size
COMP-CONT/05	5.7	N140 P100 K180	70lt



Substrate 2			
Blend of white sphagnum peat and frozen through black sphagnum peat, water soluble fertiliser plus trace elements added. For growing on of salt-tolerant plants e.g Pelargonium, Chrysanthemum, Fuchsia and bedding plants.			
Code	pH	Nutrients Added	Bag Size
COMP-POTT/14	6	N280 P200 K 360	70lt



Growing Media



Traditional Growers Compost

All the products within the traditional growers range are available as full direct loads of 26 pallets.

Code	Bag Size	Product	Description	Peat Grade	Added Fertiliser	Added Lime
8GCQ4U75	75lt	Q4 Universal	All-purpose compost for all year round use	100% 10mm	Vitax Q4, 5.3-7.5-10+3 MgO+TE – 3.5kg/m3	3.5kg/m3
COMP-SEED/12	75lt	Modular Seed	Traditional compost for seed sowing, cuttings and transplants.	100% 0-5mm	7-21-21 + 4 MgO+TE – 1kg/m3	3.5kg/m3
COMP-POTT/19	75lt	Potting	Free flowing compost for planting pots, trays, hanging baskets and tubs	50% 0-10mm 50% 0-15mm	13-11-23 + 1.5 MgO+TE – 1.8kg/m3	3.5kg/m3
COMP-POTT/26	75lt	Medium Coarse Potting	Medium coarse compost for bedding, pots and trays.	100% 0-15mm	13-11-23 + 1.5 MgO+TE – 1.8kg/m3	3.5kg/m3
COMP-POTT/20	75lt	Pot Bedding	For raising bedding pots, trays, hanging baskets and tubs.	100% 0-10mm	13-11-23 + 1.5 MgO+TE – 1.5kg/m3	3.5kg/m3
COMP-PRIM/01	75lt	Primula and Pansy	Compost blend designed for the propagation of primulas and pansies in pots and trays.	60% 0-10mm 40% 0-15mm	13-11-23 + 1.5 MgO+TE – 1kg/m3	3.5kg/m3
COMP-CONT-07	75lt	Container	Blended product for container grown plants.	40% 0-10mm 60% 0-25mm	13-11-23 + 1.5 MgO+TE – 1kg/m3	2.5kg/m3
COMP-TREE/07	75lt	Tree & Shrub	Formulated for outdoor planting of trees and shrubs.	50% 0-10mm 50% 0-25mm	Vitax Q4, 5.3-7.5-10+3 MgO+TE – 2.5kg/m3	2.5kg/m3

Multipurpose

A consistent, high quality compost with a nutrient enriched formula and wetting agent to ensure easier watering. Used for seed sowing, potting, containers and hanging baskets.

Code	Bag Size
COMP-MULTI/11	40lt
COMP-MULTI/12	60lt
COMP-MULTI/13	75lt



Tub & Basket Gold

A professional quality compost for the hobby gardener, with unique water holding polymer & slow release fertiliser for optimum performance.

Code	Bag Size
COMP-TUB/02	50lt



John Innes Enriched Multipurpose

A high quality multi-purpose compost with added John Innes to increase water holding capacity and nutrient retention. Suitable for bedding plants, pot plants and shrubs. Use in tubs, containers and hanging baskets.

Code	Bag Size
COMP-MULTI/14	60lt



Garden Peat

Containing the highest quality sphagnum moss peat, this product helps improve natural drainage and aeration of heavy clay-type soils, while adding structure to light, sandy soils.

Code	Bag Size
PEAT-01	60lt

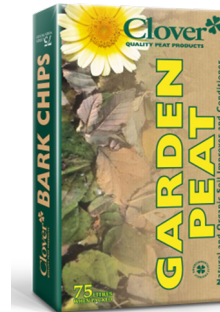

Ericaceous

A carefully formulated compost containing all the essential nutrients, trace elements and a wetting agent, pH adjusted for lime hating plants. Suitable for Heathers, Camellias, Azaleas, Rhododendrons and other lime hating species.

Code	Bag Size
COMP-ERIC/02	40lt
COMP-ERIC/03	75lt



4 Plant Grow Bag

A high quality full size growing bag containing all the nutrients required to grow a wide variety of edible and ornamental crops.

Code	Bag Size
COMP-GROW/02	4 Plants



Growing Media



John Innes No1		NS
A traditionally formulated John Innes compost for sensitive subjects, pricking out of seedlings and bedding plants.		
Code	Bag Size	
COMP-JOHN/01	25lt	



Farmyard Manure		NS
Blended farm yard manure, a completely natural and organic garden fertiliser and soil improver		
Code	Bag Size	
MANURE/04	40lt	

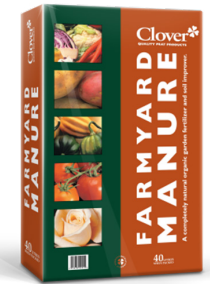

John Innes No2		NS
A traditionally formulated John Innes compost for potting on of bedding plants and vegetable plants.		
Code	Bag Size	
COMP-JOHN/03	25lt	



Bloom & Gro Multipurpose Compost		
A high quality range of Irish compost for garden centres and growers. Available as a professional potting & bedding compost in a 75lt bag or as a traditional multi-purpose in a 56lt bag.		
Code	Product	Bag Size
COMP-MULTI/21	Multi Purpose	56lt
COMP-POTT/02	Pot Bedding	75lt



John Innes No3		NS
A traditionally formulated John Innes compost for final potting, suitable for tomatoes, chrysanthemums, tubs, baskets and shrubs.		
Code	Bag Size	
COMP-JOHN/04	25lt	



Peat Free Growing Medium

<p>Sylvamix Potting</p> <p style="text-align: right;">Melcourt Industries Limited Proven • Safe • Sustainable</p>				
<p>A fine, free-flowing ready-to-use peat-free growing medium suitable for a wide range of nursery applications including bedding, herbaceous perennials and pot plants.</p> <ul style="list-style-type: none"> • A popular bedding and perennials mix • Versatile, all-round uses • Standard base fertiliser level 				
Code	Particle size	Nutrients Added	pH	Bag Size
COMP-POTT/25	0-6mm	N250 P80 K300	6.5	50lt

<p>Sylvamix Nursery Stock</p> <p style="text-align: right;">Melcourt Industries Limited Proven • Safe • Sustainable</p>				
<p>An open-structured, free-flowing ready to use peat-free growing medium suitable for a wide range of non-ericaceous nursery stock including trees.</p> <ul style="list-style-type: none"> • Open-structured, long-lasting porosity • Lower base fertiliser level • Ideal for a wide range of nursery stock and trees 				
Code	Particle size	Nutrients Added	pH	Bag Size
COMP-CONT/11	0-6mm	N200 P70 K300	6	50lt

<p>Sylvamix Seed & Cutting</p> <p style="text-align: right;">Melcourt Industries Limited Proven • Safe • Sustainable</p>				
<p>A free-flowing, ready-to-use peat-free growing medium. Use for all types of vegetative propagation and for all but the finest seeds. Provides perfect conditions for excellent root initiation.</p> <ul style="list-style-type: none"> • Compatible with most propagation systems • Compatible with liquid feeding and controlled release fertilisers • Excellent wetting capacity 				
Code	Particle size	Nutrients Added	pH	Bag Size
COMP-SEED/13	0-6mm	N150 P80 K200	6.2	50lt



Growing Media

Sylvamix Natural				
<p>A free flowing ready-to-use, Soil Association approved peat-free growing medium suitable for a wide range of applications including ornamental and food crops.</p> <ul style="list-style-type: none"> • Enables cost effective, organic peat free production • Includes a balanced, approved organic fertiliser, sufficient for the first 4-6 weeks • Provides excellent air / water ratio • Soil association approved 				
Code	Particle size	Nutrients Added	pH	Bag Size
COMP-NATU/02	0-6mm	N120 P70 K450	6.5	50lt

Sylvamix Special		
<p>Sylvamix® Special is the prescription mix service fulfilling the specific requirements of individual growers, incorporating modifications to the standard formulae of Sylvamix® Potting and Sylvamix® Nursery Stock .</p> <ul style="list-style-type: none"> • Contains Melcourt Growbark®, Melcourt Sylvafibre® two widely used and proven products • Can include other bulk ingredients such as coir, green compost and clay granules • Contains wetting agent • Can include controlled release fertilisers • Can include pesticides 		
Bag Size	Pallet City	Nutrients Added
50lt	60	You choose

Sylvamix Hanging Basket				
<p>A fine, free-flowing ready-to-use peat-free growing medium ideal for a wide range of applications . where a moisture-retentive mix is required, for example hanging baskets, tubs and troughs.</p> <ul style="list-style-type: none"> • Tried and tested under a wide range of conditions • Includes balanced fertilisers, sufficient for the first 4-6 weeks • Use in hanging baskets, tubs, troughs, bedding plants, pot plants, herbaceous perennials, 				
Code	Particle size	Nutrients Added	pH	Bag Size
COMP-HANG/01	0-6mm	N250 P80 K300	6.5	50lt



Peat Free Growing Medium

Sylvagrow Multipurpose				Melcourt Industries Limited Proven • Safe • Sustainable
Sustainable growing medium for gardeners who are as passionate about the environment as their gardens. 100% peat free.				
Code	Particle Size	Nutrients Added	PH	Bag Size
COMP-MULTI/16	0-6mm	N250 P80 K300	6.5	50lt

Sylvagrow Ericaceous Compost				Melcourt Industries Limited Proven • Safe • Sustainable
Sustainable, 100% peat free growing medium for lime hating plants. Suitable for a wide range of garden applications including potting-on, planting out and as a growing bag.				
Code	Nutrients Added	PH	Bag Size	
COMP-ERIC/08	N200 P60 K280	5.8	50lt	

Sylvagrow Multipurpose with added John Innes				NS
Superb quality, 100% peat-free compost with added sterilised loam.				
Code	Particle Size	Nutrients Added	PH	Bag Size
COMP-MULTI/23	0-6mm	N170 P60 K290	6.5	50lt

Sylvagrow Organic growing medium				
SylvaGrow® Organic Growing Medium is a unique blend of fine bark (a by-product of sustainably managed British forests), green compost (a carefully-sourced, certified ingredient) and coir (from a single, known source) .				
Code	Particle Size	Nutrients Added	PH	Bag Size
COMP-MULTI/25	0-6mm	N150 P80 K300	6.5	50lt

Please contact East Riding Horticulture for the full Melcourt range



Barks, Mulches & Compost Additives

TerrAktiv Containermulch

Pot topping bark. Excellent adhesive properties mean it forms a stable covering layer that is not washed or blown away by rain or wind. Permeable to water and useable with all sprinkler systems, it is also attractive in colour.



we make it grow



Code	Bag Size
COMP-CONT/09	70lt

Sinclair Pot Topper

Sinclair Pot Topper can be used as a pot topper or for mulching beds and borders. It is a superior alternative to bark; not only does it prevent weed seeds from germinating but also due to its consistency and sterility and its adhesive properties which lock the fibres together to ensure they remain in situ even if inverted. This creates a matted surface layer that is impenetrable to light sources that weeds require to establish, whilst still permitting the transfer of water to the root zone for plant uptake.

- Extremely low nutrient content preventing weed seed, liverwort and moss establishment
- Adhesive properties – fibres lock together and stay in situ
- Matted layer provides an impenetrable light barrier that prevents weed establishment
- Produced from 100% FSC certified virgin wood source
- The product is heat-sterilised and as a result is free from weeds, disease and pests
- Unique colouration improves wettability and aesthetics
- Helps reduce evaporation
- Water permeable
- Helps insulate growing media, garden beds and borders
- Suitable for ericaceous plants
- Will remain in place offering a neat and tidy cover

Coverage Table	
Location/depth	Bag covers
Beds & Borders/3cm depth	5sq.m
Planters/containers/pots* 3cm depth	39 pots
*based on 40cm circular pot	

Code	Bag Size
POT-TOPPER/01	100lt



Propagating Bark Soil Association approved			
A fine, substantially dust free, matured, British pine bark designed for use in mixes with peat or suitable alternatives for the vegetative propagation of nursery stock and a wide range of other plants. Also an excellent pot mulch to suppress weed, moss and liverwort growth			
Code	pH Range	Particle Size	Bag Size
BARK-PROP/01	4.5-5.5	2-7mm	60lt



EcoBark® Topper Soil Association approved			
An attractive, dark-coloured mixed-conifer bark designed for pot mulching where it offers excellent resistance to disturbance and natural suppression of moss, liverwort and weed growth. FSC Certified® (FSC®).			
Code	pH Range	Particle Size	Bag Size
BARK-TOPP/01	5.0-6.0	0-12mm	60lt



Potting Bark Soil Association approved			
A matured, British pine bark chip, mid to dark brown in colour, with virtually no fines, designed for incorporation into peat-based or peat-free growing media, to improve both air-filled porosity and long term structural stability. Also an excellent pot mulch to suppress weed, moss and liverwort growth.			
Code	pH Range	Particle Size	Bag Size
BARK-POTT/01	4.5-5.5	3-15mm	60lt



Orchid Bark Coarse Soil Association approved			
A chunky, fine-free pine bark, designed for use in orchid composts where it provides extremely free drainage and long-term structural stability.			
Code	pH Range	Particle Size	Bag Size
BARK-ORCHID/01	5-5.5	15-35mm	60lt



GrowBark Pine Soil Association approved			
A fine, matured, European pine bark designed as a major growing medium ingredient. An ideal additive to peat and its alternatives.			
Code	pH Range	Particle Size	Bag Size
BARK-PINE/06	4.5-5.5	0-6mm	60lt



Orchid Bark Medium Soil Association approved			
A chunky, fine-free pine bark, designed for use in orchid composts where it provides extremely free drainage and long-term structural stability.			
Code	pH Range	Particle Size	Bag Size
BARK-ORCHID/02	5-5.5	5-15mm	60lt



Barks, Mulches & Compost Additives

Melcourt
Industries Limited
Proven • Safe • Sustainable



Spruce Ornamental		
A popular high performance mulch, from our 'contract' range suitable for a wide range of professional landscape applications, including prestigious sites, car parks, superstores, business parks, tubs, plant and window boxes. This product is from FSC Mix Sources at a minimum of 70%.		
Code	Particle Size	Bag Size
BARK-ORN/08	5-35mm	60lt

Melcourt
Industries Limited
Proven • Safe • Sustainable



Pine Mini Chips		
A neat, small chip, high performance mulch, from our 'deluxe' range, suitable for a wide range of mulching applications, particularly on smaller beds and borders or tubs, pots, window boxes and roof gardens. This product is from FSC Mix Sources at a minimum of 70%.		
Code	Particle Size	Bag Size
BARK-PINE/03	3-18mm	60lt



Ornamental Bark Mulch		
A high performance mulch from our 'deluxe' range suitable for a wide range of smaller-scale professional and domestic landscape applications, where a neat, decorative finish is required. This product is from FSC Mix Sources at a minimum of 70%.		
Code	Particle Size	Bag Size
BARK-ORN/09	5-35mm	60lt

Contract Bark Mulch		
A versatile mulch from our 'economy' range, suitable for a wide range of professional landscape applications.		
Code	Particle Size	Bag Size
BARK-CONTRACT/01	0-65mm	1m3 (Loose)



Bark Nuggets		
A long lasting, versatile, high performance mulch from our 'deluxe' range, suitable for a wide range of professional and domestic landscape applications, including prestigious sites. Particularly effective when a high quality, decorative finish is required. This product is from FSC Mix Sources at a minimum of 70%.		
Code	Particle Size	Bag Size
BARK-PINE/04	15-65mm	60lt

Melcourt[®]
Industries Limited
Proven • Safe • Sustainable

Highland Bark

Composted Bark		
<p>A pulverised and composted bark created from mixed conifer species. Suitable for mulching where it is an ideal dark rich mulch for borders and rose beds. Used to create a pleasing contrast between green foliage and flowers whilst at the same time giving economy through its weed suppression characteristics. The product also helps to protect against adverse weather conditions in that it allows the soil to retain moisture during dry times, but keeps soil temperature up during cold spells.</p> <p>*Due to pH levels, Composted Bark is not recommended for use on soil areas containing Ericaceous plants.</p>		
Code	Particle size	Bag Size
BARK-COMP/04	0-6mm	70lt



Ornamental Bark		
<p>Top quality chipped bark utilising the best raw materials available. The product is highly decorative in appearance and can be used for all mulching operations where aesthetics are of primary importance.</p> <p>The product is long lasting if maintained properly and laid to a minimum of 50mm depth.</p>		
Code	Particle size	Bag Size
BARK-ORN/01	10-25mm	70lt
BARK-ORN/03	10-25mm	1m3 (BB)
BARK-ORN/02	10-25mm	1m3 (Loose)



Nursery Bark		
<p>Top quality chipped bark utilising the best raw materials available. The product is highly decorative in appearance and can be used for all mulching operations where aesthetics are of primary importance.</p> <p>The product is long lasting if maintained properly and laid to a minimum of 50mm depth.</p>		
Code	Particle size	Bag Size
BARK-NURS/01	5-10mm	70lt



Ornamental Pine Bark		
<p>Top quality chipped bark utilising the best raw materials available. The product is highly decorative in appearance and can be used for all mulching operations where aesthetics are of primary importance.</p> <p>The product is long lasting if maintained properly and laid to a minimum of 50mm depth.</p>		
Code	Particle size	Bag Size
BARK-PINE/01	10-25mm	70lt

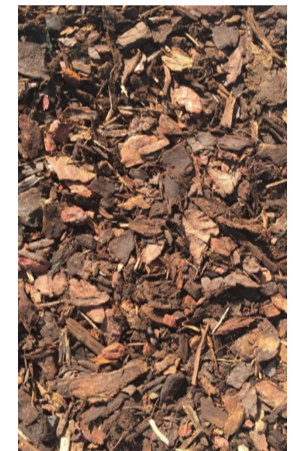

Barks, Mulches & Compost Additives

Sands & Grits

Potting Grit	
Horticultural grade lime-free washed coarse grit. Nominal 4mm down. Uses: Top dressing pots, alpines and rock plants, cacti and succulents, aquariums & pools .	
Code	Bag Size
GRIT/01	20kg



Silver Sand	
Horticultural grade lime-free washed silica sand. Nominal 1mm down. Uses: Seed composts, cuttings and top dressing lawns.	
Code	Bag Size
SAND-SILVER/01	20kg



Sharp Sand	
Horticultural grade lime-free washed quartzite sharp sand. Nominal 3mm down. Uses: Seed and cutting composts, top dressing lawns, laying paving slabs, mortar and plaster .	
Code	Bag Size
SAND-SHARP/01	20kg



Play Sand	
Play Pit Sand is perfect for kids of all ages to play in. Whether you're looking to develop your creativity or just after a safe area in which your children can play, a sand play pit is the perfect solution. Our Play Pit Sand is ideal for use at home, in schools and nurseries and can also be used for Long Jump Pits in schools and by athletic clubs. Also ideal for manufactured beach areas.	
Code	Unit Of Sale
SAND-PLAY/01	20kg
SAND-PLAY/02	880kg (Bulk Bag)
SAND-PLAY/03	Tonne (Loose)



Grit Sand	
Horticultural grade lime-free washed grit sand. Nominal 5mm down. Uses: Potting compost, cacti and succulents, alpine and rock plants, improving heavy soils.	
Code	Bag Size
GRIT/02	20kg



Vermiculite

A naturally occurring, non-toxic, soft mica mineral. Heated to a high temperature which produces a lightweight, sterile, laminated structure. Vermiculite has a natural pH between 6-7.

Vermiculite Fine				
Useful for aiding the water management of peat composts as it retains water more strongly than peat and so extends watering intervals and provides a nucleus for re-wetting. Acts as a nutrient buffer.				
Code	Granule Size	Usage	Water Holding	Pack Size
VERM/02	1-3mm	Use up to 50% by volume	419ml/litre	100lt

Vermiculite Medium				
Useful for improving aeration without impacting adversely on water capacity or water retention. It can also be used for seed covering.				
Code	Granule Size	Usage	Water Holding	Pack Size
VERM/03	2-5mm	Use up to 50% by volume	381ml/litre	100lt

Vermiculite Coarse				
Useful when higher aeration levels are required without impacting adversely on water capacity or water retention.				
Code	Granule Size	Usage	Water Holding	Pack Size
VERM/01	5-10mm	Use up to 50% by volume	322ml/litre	100lt

Perlite

Perlite's honeycomb internal cells help to improve aeration and insulates growing media, reducing large temperature fluctuations.

Perlite Fine			
Useful for aiding the water management of peat composts as its small pores strongly retain water. It's ability to adhere to the surface of the peat promotes wetting and the capillary movement of water means that composts are also easier to manage, wetting up easily and with uniform water distribution.			
Code	Granule Size	Usage	Pack Size
PERLITE/02	0.15-2mm	Use up to 20% by volume	100lt

Perlite Standard			
Useful for increasing aeration in larger containers and producing a well-drained environment for root growth.			
Code	Granule Size	Usage	Pack Size
PERLITE/03	2-5mm	Use up to 40% by volume	100lt

Perlite Super Coarse			
Useful for increasing aeration in larger containers and producing a well-drained environment for root growth.			
Code	Granule Size	Usage	Pack Size
PERLITE/01	3-6mm	Use up to 20% by volume	100lt

Growing Media Wetting Agents

H2Gro Granules 			
H2Gro is a unique blend of surfactants based on 3D technology with a multi-matrix effect. It is a unique water conservation wetting agent that holds the maximum amount of water, in water repellent materials, within the growing media.			
Code	Pack Size	Incorporation Rate	Topdress Rate
H2GRO/01	10kg	0.5-1kg/m3	40g/m3



H2Gro Liquid 			
H2Gro is a unique blend of surfactants based on 3D technology with a multi-matrix effect. It is a unique water conservation wetting agent that holds the maximum amount of water, in water repellent materials, within the growing media.			
Code	Pack Size	Incorporation Rate	Drench Rate
H2GRO/02	5lt	50-150ml/m3	50-100ml/100lt water



Aquamix		
Aquamix prevents and corrects hydrophobic soil/growing medium by allowing water to penetrate and spread easily throughout the potting soil.		
Code	Incorporation Rate	Pack Size
AQUA/03	100-200ml /m3	5lt



Solusorb A			
Water retaining polymer granules for improved water management in hanging baskets, patio tubs and many other plant growing situations.			
Solusorb A is a synthetic superabsorbent polymer designed to improve the water retaining properties of many types of growing media with wide applications.			
Also suitable for use as transplanting aid to reduce “transplant shock” and its effects.			
Code	Particle Size	Bulk Density	Pack Size
SOLU/-1	0.5 - 3.0mm	Approx. 0.8kg/m3	1kg
SOLU	0.5 - 3.0mm	Approx. 0.8kg/m3	25kg

Zeba XL 			
Zeba XL is a patented soil enhancement designed to keep a constant supply of moisture available to germinating seed, seedlings and plants throughout the growing season. It is ideal for use in a wide range of agricultural, turf and ornamental applications.			
<ul style="list-style-type: none"> • It has the function to absorb water up to 495 times its own weight • Increases the soil's water holding capacity & positively impacting on water use efficiency • Very high Cation Exchange Capacity (CEC) positively impacts on nutrient use efficiency 			
Code	Application Rate (Substrate Inclusion)	Application Rate (Ornamentals)	Pack Size
ZEBA	300 - 2000gm3	4.5-10kg/Ha	5kg



Fertiliser, Liquid Feeds & Plant Health Stimulants

Osmocote Exact Standard

Osmocote Exact Standard is developed to release nutrients steadily throughout the entire growing season. Osmocote Exact Standard is the best choice for plants that have equal nutrient demands throughout the entire growing cycle. The target crops are evergreens and deciduous shrubs. It is also ideal when no more than one release pattern can be applied.

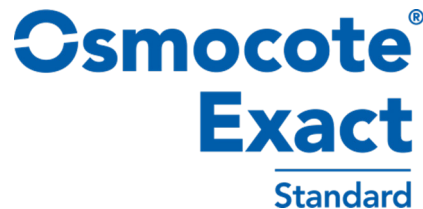

Osmocote Exact Standard			8-9M
Its safety makes Osmocote Exact Standard 8-9 M highly suitable for pot plants. The longevity of Osmocote Exact Standard 8-9M is affected by temperature. (Product longevity is determined at 21°C)			
Code	Pack Size	Analysis	Longevity
OSMO-8M/04	25kg	15-9-11+2MgO+TE	8-9 Months



Osmocote Exact Standard			3-4M
Osmocote Exact Standard 3-4 M is especially suitable for late potting with good growing plant material and short crop cycles. The longevity of Osmocote Exact Standard 3-4M is affected by temperature. (Product longevity is determined at 21°C)			
Code	Pack Size	Analysis	Longevity
OSMO-3M/03	25kg	16-9-12+2MgO+TE	3-4 Months



Osmocote Exact Standard			12-14M
Its safety makes Osmocote Exact Standard 12-14 M highly suitable for pot plants. The longevity of Osmocote Exact Standard 12-14M is affected by temperature. (Product longevity is determined at 21°C).			
Code	Pack Size	Analysis	Longevity
OSMO-12M/05	25kg	15-9-11+2MgO+TE	12-14 Months



Osmocote Exact Standard			5-6M
Its safety makes Osmocote Exact Standard 5-6 M highly suitable for pot plants. The longevity of Osmocote Exact Standard 5-6M is affected by temperature. (Product longevity is determined at 21°C).			
Code	Pack Size	Analysis	Longevity
OSMO-5M/06	25kg	15-9-12+2MgO+TE	5-6 Months



Osmocote Exact Standard Lo Start			16-18M
Osmocote Exact Lo Start has been developed especially for slow-growing conifers and salt sensitive crops. Nutrient release with Osmocote Exact Lo Start is relatively low at the start. It is ideal for situations where a slow start is required, such as slow rooting young plants and early potting in tunnels.			
Code	Pack Size	Analysis	Longevity
OSMO-16M/01	25kg	15-8-11+2MgO+TE	16-18 Months



Osmocote Exact Hi.End

Osmocote Exact Hi.End is a high-tech 'programmed release' fertiliser. The product longevity and release pattern are predefined. Powered by Double Coating Technology, part of the product will only begin being released 2.5 – 3 months after application, during the critical growing phase. The result is very effective nutrition and improved plant growth. This enables growers to fertilise more effectively.



Osmocote Exact Hi.End is an excellent choice for growers cultivating plants with an increased nutrient demand in the second growing phase.

Code	Product	Pack Size	Analysis	Longevity (Months)
OSMO-5M/01	Osmocote Exact Hi End	25kg	15-9-12+2MgO+TE	5-6
OSMO-8M/01	Osmocote Exact Hi End	25kg	15-9-11+2MgO+TE	8-9
OSMO-12M/01	Osmocote Exact Hi End	25kg	15-9-11+2MgO+TE	12-14

Osmocote Exact Hi K

The controlled release fertiliser for growing compact plants.

Osmocote Exact High K is ideal for pot plants, perennials, container nursery stock and bedding plants. Using our innovative DCT technology*, the Osmocote Exact High K range shows higher efficiency and ultimate performance. DCT optimises the timing of nutrient release, enabling programmed release, so that it matches the plant's needs perfectly. Plant safety is maximised even when the fertiliser is applied in warm conditions (greenhouses or tunnels).



*Osmocote Exact High K is available in three longevitys powered by DCT: 5-6, 8-9 and 12-14 months. The 3-4 month longevity is a 3rd generation product without DCT technology.

Code	Product	Pack Size	Analysis	Longevity (Months)
OSMO-3M/04	Osmocote Exact Hi K	25kg	12-7-19+TE	3-4
OSMO-5M/02	Osmocote Exact Hi K	25kg	12-7-19+TE	5-6
OSMO-8M/02	Osmocote Exact Hi K	25kg	12-7-19+TE	8-9
OSMO-12M/02	Osmocote Exact Hi K	25kg	12-7-19+TE	12-14

Fertiliser, Liquid Feeds & Plant Health Stimulants

Osmocote Exact Protect

Osmocote Exact Protect is a programmed release fertiliser in Osmocote's fourth-generation range of products. These products feature Dual Coating Technology that delays the second delivery of nutrients until after two to three months. Osmocote Exact Protect can be applied at full rate, meaning all the nutrients are saved until the plant is able to take them up. What's more, additional topdress applications in the spring are usually not required.



Osmocote[®]
Exact
DCT

Code	Product	Pack Size	Analysis	Longevity (Months)
OSMO-5M/08	Osmocote Exact Protect 5-6M	25kg	14-8-11+2MgO+TE	5-6 M
OSMO-8M/05	Osmocote Exact Protect 8-9M	25kg	14-8-11+2MgO+TE	8-9 M
OSMO-12M/06	Osmocote Exact Protect 12-14M	25kg	14-8-11+2MgO+TE	12-14 M

Osmocote Exact Tablets

Osmocote Exact Tablets provide an easy way for growers to administer extremely accurate doses of nutrients. The tablet's cone shape makes it very easy to push into the growing medium. They are made of an environmentally friendly adhesive that is water soluble. The tablets disintegrate after the plants are watered and at that point they lock into the growing medium.

The tablets are available in 5 gram and 7.5 gram.



Osmocote[®]
Exact
Tablet

code	Product	Tablet Weight	Analysis	Longevity
OSMO-TAB/01	Osmocote Exact Tablet 5-6M	5g	14-8-11+2MgO+TE	5-6 M
OSMO-TAB/02	Osmocote Exact Tablet 5-6M	7.5g	14-8-11+2MgO+TE	5-6 M
OSMO-TAB/04	Osmocote Exact Tablet 8-9M	5g	14-8-11+2MgO+TE	8-9 M
OSMO-TAB/03	Osmocote Exact Tablet 8-9M	7.5g	14-8-11+2MgO+TE	8-9 M

Fertiliser, Liquid Feeds & Plant Health Stimulants

Osmocote Pro

Osmocote Pro is ICL Specialty Fertilisers' second-generation coated fertiliser. It is fully coated and packed with NPK, magnesium and all the necessary microelements. Plus it has a fixed longevity ranging from 3 – 4 months up to 12 – 14 months. Osmocote Pro features a regular release pattern and can be used in full rates or as a base dressing combined with water-soluble feedings.

In specific situations* Osmocote Exact is recommended for maximum performance, safety and guarantees.

*eg. high rates, when using plant hole dibbling, sensitive and/or high value crops, or in difficult growing circumstances like greenhouses.



Code	Product	Pack Size	Analysis	Longevity
OSMO-3M/02	Osmocote Pro 3-4M	25kg	19-9-10+2MgO+TE	3-4 M
OSMO-5M/05	Osmocote Pro 5-6M	25kg	19-9-10+2MgO+TE	5-6 M
OSMO-8M-03	Osmocote Pro 8-9M	25kg	18-9-10+2MgO+TE	8-9 M
OSMO-12M-04	Osmocote Pro 12-14M	25kg	18-9-10+2MgO+TE	12-14 M
OSMO-5M-08	Osmocote Pro High K 5-6M	25kg	11-10-19+2MgO+TE	5-6 M
OSMO-8M-06	Osmocote Pro High K 8-9M	25kg	11-10-19+2MgO+TE	8-9 M

Osmocote Start

Osmocote Start offers a good fertiliser for annual plants with a short growth cycle, such as violets, primulas, impatiens and marigolds. It is also ideal for salt-sensitive vegetable crops and cuttings that have difficulty with rooting.

Code	Analysis	Longevity	Pack Size
OSMO-START	11-11-17+2MgO+TE	6 Weeks	25kg



Osmocote Bloom

Osmocote Bloom provides an exceptionally sustainable way to grow bedding plants with minimal leaching and optimum fertiliser usage. Plants are fed from start to finish – from potting to the first consumer phase.

Code	Analysis	Longevity	Pack Size
OSMO-BLOOM	12-7-18+TE	2-3 Months	25kg



Osmocote Topdress FT

Osmocote Topdress FT is a coated fertiliser that is specially developed for topdress applications in container nursery stock. It contains Fusion Technology: a special component that makes the product stick onto the growing medium after application. This means no granules are lost if the pots are blown over.

Code	Analysis	Longevity	Pack Size
OSMO-TD-FT	22-5-6+ 2MgO +TE	4-5 Months	25kg



Fertiliser, Liquid Feeds & Plant Health Stimulants

Basacote® Controlled Release Fertiliser

Basacote is the Compo Expert brand for fully coated controlled release fertilisers.

- Controlled release of all macro and micro elements
- Safe fertiliser for optimal and even plant development
- No salinity
- Labour savings by long term release
- Unique micro element placement underneath elastic coating layer

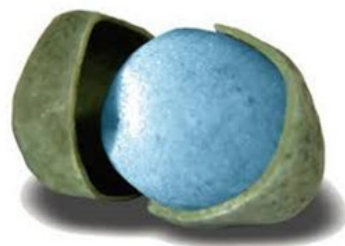

Basacote® Plus 3M

Controlled release NPK complex fertiliser, fully coated, with whole set of trace elements. For depot fertilisation of bedding & balcony plants, or other crops with short cultivation period.

Code	Analysis	Longevity	Pack Size
BASACOTE/04	16-8-12+2MgO+TE	3 Months	25kg



Basacote® Plus 6M

Controlled release NPK complex fertiliser, fully coated, with whole set of trace elements. For depot fertilisation of substrate mixes for container nursery stock and plant hole fertilisation.

Code	Analysis	Longevity	Pack Size
BASACOTE/05	16-8-12+2MgO+TE	6 Months	25kg



Basacote® Plus 9M

Controlled release NPK complex fertiliser, fully coated, with whole set of trace elements. For depot fertilisation of substrate mixes for container nursery stock and plant hole fertilisation.

Code	Analysis	Longevity	Pack Size
BASACOTE/06	16-8-12+2MgO+TE	9 Months	25kg



Basacote® Plus 12M

Controlled release NPK complex fertiliser, fully coated, with whole set of trace elements. For depot fertilisation of substrate mixes for container nursery stock and plant hole fertilisation.

Code	Analysis	Longevity	Pack Size
BASACOTE/03	15-8-12+2MgO+TE	12 Months	25kg



Fertiliser, Liquid Feeds & Plant Health Stimulants

Novatec® Slow Release Fertiliser

Novatec® is an NPK complex fertiliser with nitrification inhibitor DMPP.

It reduces N-leaching and increases N-efficiency. During the active phase of DMPP (4 to 10 weeks, depending on soil temperature and soil humidity) the transformation of ammonium to nitrate is delayed. As a result N-availability is further adapted to the plants' requirements and N-efficiency is increased.

Novatec® Supreme

NPK complex fertiliser for crops with high nitrogen demand.

Code	Analysis	Longevity	Pack Size
NOVA/05	21-5-10+3MgO+TE	10 weeks	25kg



Novatec® Classic

NPK complex fertiliser for all crops and on soils with poor or moderate phosphate supply.

Code	Analysis	Longevity	Pack Size
NOVA/01	12-8-16+3MgO+TE	10 weeks	25kg



Novatec® N-Max

NPK complex fertiliser for crops with very high N - demand and for top dressing.

Code	Analysis	Longevity	Pack Size
NOVA/02	24-5-5+2MgO+TE	10 weeks	25kg



Novatec® Premium

NPK complex fertiliser for soils with high phosphate content.

Code	Analysis	Longevity	Pack Size
NOVA/03	15-3-20+TE	10 weeks	25kg



Floranid® Permanent

Use for top dressing containerised nursery stock, field grown nursery and on established trees and shrubs.

Code	Analysis	Longevity	Pack Size
FLORP	16-7-15+2MgO+TE	8-12 weeks	25kg



Allotment & Garden Fertilisers

General Purpose Fertilisers			
Code	Product	Pack Size	Analysis
GROW/03	Growmore	25kg	7-7-7
FISH/01	Fish Blood & Bone	25kg	5-5-6
BONE/01	Bone Meal	25kg	3.5-18-0
POULTRY/02	Poultry Pellets	20kg	-



Straight Fertilisers			
Code	Product	Pack Size	Analysis
NITRA/02	Nitrate Of Chalk	25kg	-
AMON	Sulphate Of Ammonia	25kg	21-0-0
SUPER	Single Superphosphate	25kg	0-18-0
TRIPSP	Triple Superphosphate	25kg	0-46-0
KEISERITE	Keiserite	25kg	15%Mg
POTASH/05	Sulphate Of Potash	25kg	0-0-50
IRON/09	Sulphate Of Iron	25kg	20%Fe HEPTA



Flower & Vegetable Fertilisers			
Code	Product	Pack Size	Analysis
VEGA/01	TE Flower & Vegetable	25kg	5-7.5-10+1.7Mg+TE
VEGA/02	High N Flower & Veg	25kg	10-7.5-10+1.7Mg+TE
POTATO/01	Potato	25kg	6-10-10
ONION/01	Onion	25kg	6-8-15+5Mg
ROSE/11	Rose	25kg	5-5-10+0.6Fe+0.6Mg
CHRYSANTH/01	Chrysanthemum	25kg	5-8-11

Organic Straight Fertilisers			
Code	Product	Pack Size	Analysis
HOOF	Hoof & Horn	25kg	-
DRIE	Dried Blood	25kg	12% N

Base Mixes			
Code	Product	Pack Size	Analysis
JOHN/01	John Innes Base	25kg	-
THOM6/03	TE Base Top Dressing	25kg	6-8-10
THOM6/01	Trench	25kg	6-11-18

Soil Conditioners, Compost Activator & Liquids			
Code	Product	Pack Size	Analysis
SEAWEED/03	Calcified Seaweed	25kg	-
GARRO	Compost Activator (Garotta)	25kg	-
GROW/08	Growmore Liquid	20lt	7-7-7
TOMATO/01	Tomato Liquid	20lt	5-5-10

Fertiliser, Liquid Feeds & Plant Health Stimulants

Vitax Q4

Originally developed for use as a base fertiliser in John Innes composts, and still approved for use in JI formulations, Q4 has proved an extremely versatile fertiliser suitable for use on a wide variety of crops. Q4 provides all the nutrients and trace elements essential for vigorous growth, abundant flowering and ripening of fruit.

Code	Analysis	Pack Size
Q4/02	5-7.5-10+1.7Mg+TE	25kg



Vitax Q4HN

The high nitrogen formulation of Q4 with additional extended release nutrients, making it the ideal choice as both base and top dressing for containerised nursery stock and field-grown trees and shrubs. The extra iron content is beneficial for ericaceous plants.

Code	Analysis	Pack Size
Q4/03	10-7.5-10.2+TE	25kg



Approved Natural Pelleted Fertilisers

Suitable for all types of organic crops, these fertilisers help improve soil microbial activity to achieve greater utilisation of applied nutrients. This activity also improves the release of nutrients which may be locked up in the soil.

Code	Product	Analysis	Pack Size
FERT-NAT-O/01	Natural 111	4.5-4.5-4.5+0.8%Mg	20kg
FERT-NAT-O/01	Natural 214	4.5-2.0-7.5+0.8%Mg	20kg
FERT-NAT-O/01	Natural High K	0.5-0.5-2.0+1.6Mg	20kg



Dolomite

Dolomite from Omya is a powdered liming agent containing calcium and magnesium carbonate, which whilst offering a source of magnesium is generally incorporated into compost and soils in order to raise the pH.

- Source of magnesium
- Also known as Dolodust

Code	Contains	Pack Size
LIME/03	Calcium and magnesium carbonate	25kg



Snowcal

Snowcal 10 is a liming agent containing calcium carbonate. Like Dolomite, Snowcal 10 is widely used as a liming agent to amend the pH of soils and composts. Snowcal 10 is probably better known as garden lime.

- Fine powder used to raise growing medium pH
- Snowcal 40 can be used for line marking
- Also known as garden lime

LIME	Description	Contains	Pack Size
LIME/01	Snowcal 10	Calcium carbonate	25kg
LIME/02	Snowcal 40	Calcium carbonate	25kg

Lawn Fertilisers

Sportsmaster turf fertilisers from ICL are a high quality mini-granular fertiliser range for sports and amenity turf. Sportsmaster is the industry standard fertiliser for turf mown above 6mm, the various analyses are designed to maintain turf performance throughout the year.

- 6 weeks longevity
- Ideal for lawns and recreational areas



Sportsmaster Cleanrun Pro

Weed and feed single application in spring or summer periods when broad-leaved weeds are present.

Code	Analysis	Application Rate	Pack Size
SPORT/02	14-0-5+MCPA+Mecoprop P	35g/m ²	25kg



Sportsmaster Spring & Summer

Sportsmaster Spring & Summer is an all-rounder that breaks down quickly to give rapid uptake of nutrients.

Code	Analysis	Application Rate	Pack Size
SPORT/08	9-7-7	35-70g/m ²	25kg



Sportsmaster Pre-Seeder

The high phosphorus levels in Sportsmaster Pre-Seeder enhances seed establishment and to improve rooting.

Code	Analysis	Application Rate	Pack Size
SPORT/06	8-12-8	35-70g/m ²	25kg



Sportsmaster Renovator Pro

Sportsmaster Renovator Pro is a weed, feed and mosskiller that maintains growth and contains a selective herbicide for weed control plus iron for moss control.

Code	Analysis	Application Rate	Pack Size
SPORT/07	14-0-5+Fe+MCPA+Mecoprop P	35g/m ²	25kg



Sportsmaster Autumn

Sportsmaster Autumn is perfect for pre-stress conditioning turf or for use at the end of the summer. The fertilizer ensures proper root growth before the winter season arrives.

Code	Analysis	Application Rate	Pack Size
SPORT/01	4-12-12	35-70g/m ²	25kg



Fertiliser, Liquid Feeds & Plant Health Stimulants

Greenmaster Pro-Lite is an outstanding conventional release, micro-granular homogeneous fertiliser range that delivers high quality nutrition for fine turf over a period of 4-6 weeks. The range contains various analyses designed to optimise turf health throughout the year.

Greenmaster Spring & Summer

Greenmaster Pro-Lite Spring & Summer maintains strong growth levels and enhances turf colour during the spring and summer.

Code	Analysis	Rate	Pack Size
GREENM/16	14-5-10+2MgO	30-35g/m ²	25kg



Greenmaster Autumn

Greenmaster Pro-Lite Autumn has an NPK analysis with high iron to balance turf health, harden the sward and provide moss control.

Code	Analysis	Rate	Pack Size
GREENM/01	6-5-10+6Fe	30-35g/m ²	25kg



Greenmaster Invigorator Plus

New formulation granular turf hardener with higher iron and potassium for improved colour response.

Code	Analysis	Rate	Pack Size
GREENM/08	4-0-14+2MgO+8Fe	30-35g/m ²	25kg



ProTurf is a range of high-quality, blended fertilizers with controlled release technology. Formulated to give a strong immediate response, combined with 2 - 3 month longevity. ProTurf is ideal for use on tees, surrounds, fairways, sport fields and lawns.

ProTurf 20-0-7

ProTurf 20.0.7 gives a strong initial boost coupled with longevity. Ideal for in-season applications.

Code	Analysis	Rate	Pack Size
PROT/03	20-0-7 + 3CaO+3MgO	20-35g/m ²	25kg



ProTurf 15-5-15

Contains higher level of nitrogen to kick-start growth in the spring. Balanced levels of potassium and phosphorus along with calcium and magnesium are designed to support turf needs on sand based constructions.

Code	Analysis	Rate	Pack Size
PROT/02	15-5-15 + 2CaO+2MgO	20-35g/m ²	25kg



ProTurf 12-5-20

ProTurf 12.5.20 is designed to sustain, strengthen and harden turf through the autumn and winter.

Code	Analysis	Rate	Pack Size
PROT/01	12-5-20 + 2CaO+2MgO	20-35g/m ²	25kg



Fertiliser, Liquid Feeds & Plant Health Stimulants

Water Soluble Fertiliser

Universol sets the standard for water-soluble fertilisers. The fertilisers are colour-coded for easy use and feature the “Bright Solution System”. Universol products are universally recognised for their reliability and great value for money.

Universol Green		
Universol Green can be applied if growth is the main objective, as the N:K ratio is nitrogen based (2:1). This product contains NPK, Mg and a full package of trace elements.		
Code	Analysis	Pack Size
UNIVERSOL/05	23-6-10+2.7MgO+TE	25kg



Universol Yellow		
Universol Yellow gives a boost of phosphorus and is most frequently used at the beginning, soon after potting, to stimulate the rooting of freshly planted crops. This product is also advised to support bud growth by the phosphorus aimed analysis.		
Code	Analysis	Pack Size
UNIVERSOL/08	12-30-12+2.2MgO+TE	25kg



Universol Violet		
Universol Violet has high potassium content which provides compact and strong growth, good leaf colour and good flower development. This product contains NPK, Mg and a full package of trace elements.		
Code	Analysis	Pack Size
UNIVERSOL/07	10-10-30+3.3MgO+TE	25kg



Universol Blue		
Universol Blue is a balanced formula and this product contains NPK, Mg and a full package of trace elements.		
Code	Analysis	Pack Size
UNIVERSOL/04	18-11-18+2.5MgO +TE	25kg



Universol Orange		
Universol Orange focuses on potassium to encourage flowering and slows down plant growth. Because of the higher potassium content it is ideal for flowering pot plants and bedding plants. This product contains NPK, Mg and a full package of trace elements.		
Code	Analysis	Pack Size
UNIVERSOL/06	16-5-25+3.4MgO+TE	25kg



Universol Basis		
Universol Basis is developed for application via A/B tank systems. This product contains NPK, Mg and an elevated full package of trace elements.		
Code	Analysis	Pack Size
UNIVERSOL/02	4-19-35+4.1MgO+TE	25kg



Fertiliser, Liquid Feeds & Plant Health Stimulants

Universol Soft Water 312R

Universol Soft Water 312R is developed for application in soft irrigation water. This product contains NPK, Mg, Ca and a full package of trace elements. With a nitrogen aimed N:K ratio of 3:2 and high calcium, Universol Soft Water 312R is ideal for foliar crops and for the early growing phase.

Code	Analysis	Pack Size
UNIVERSOL/11	18-7-12+6CaO+2MgO+TE	25kg

Universol Hard Water 211

Universol Hard Water 211 is developed for application in hard irrigation water, with high levels of bicarbonate. With an N:K ratio of 2:1, it is ideal for plants requiring high amounts of nitrogen during the early growth stage (e.g. foliar plants). Universol Hard Water 211 acidifies the irrigation water and neutralises bicarbonate.

Code	Analysis	Pack Size
UNIVERSOL/01	23-10-10+2MgO+TE	25kg

Universol Soft Water 113R

Universol Soft Water 113R is developed for application in soft irrigation water. This product contains NPK, Mg, Ca and a full package of trace elements. The high potassium aimed N:K ratio of 1:3 makes this formulation ideal for flowering crops and to harden off crops in their final growth phase.

Code	Analysis	Pack Size
UNIVERSOL/10	11-11-31+2CaO+2MgO+TE	25kg

Universol Hard Water 225

Universol Hard Water 225 is developed for application in hard irrigation water. It promotes compact growth in flowering plants and is ideal for hardening off plants. Universol Hard Water 225 acidifies the irrigation water and neutralizes bicarbonate. The N:K ratio of 2:5 means this product can be used in combination with water containing high nitrogen levels and with nitrogen fertilizers (e.g. Nitric acid).

Code	Analysis	Pack Size
UNIVERSOL/09	11-10-28+2MgO+TE	25kg

Universol Soft Water 213R

Universol Soft Water 213R is developed for application in soft irrigation water with low bicarbonate level. This product contains NPK, Mg, Ca and a full package of trace elements. With a potassium aimed N:K ratio of 2:3, this product is ideal for flowering crops and compact growth.

Code	Analysis	Pack Size
UNIVERSOL/03	14-7-22+5CaO+2MgO+TE	25kg



Universol®

Water Soluble Fertiliser

Peters[®] Professional



World leading 100% water-soluble fertilisers. Thanks to its exclusive M-77 chelating formula, Peters Professional assures that nutrients and trace elements remain readily available for fast and easy uptake. M-77 “unlocks” the rooting area, allowing an effective increase in the absorption of nutrients.

CalMag Finisher Soft water

Peters Excel CalMag Finisher is often used as a follow-up fertiliser to Peters Excel CalMag Grower 15-5-15. Its high potassium formula leads to a more compact growth. This Peters Excel product is a ‘single-tank mix’ solution providing plants with all the necessary nutrients from a single tank.

Code	Analysis	Pack Size
PETERS/02	14-10-26+2MgO+TE	15kg



CalMag Grower Soft water

Special formulation for use with soft water. The N:K ratio is aimed at growth.

Code	Analysis	Pack Size
PETERS/03	15-5-15+7CaO+3MgO+TE	15kg



Product	Code	Analysis	Pack Size
Combi Sol	PETERS/16	6-18-36+3MgO+TE	15kg
Plant Finisher	PETERS/17	9-9-36+3MgO+TE	15kg
Blossom Booster	PETERS/08	10-30-20+2MgO+TE	15kg
Plant Starter	PETERS/07	10-52-10+TE	15kg
Potassium Booster	PETERS/09	12-0-43+TE	15kg
Grow-Mix	PETERS/13	21-7-21+3MgO+TE	15kg
Foliar Feed	PETERS/14	27-15-12+TE	15kg



DOSATRON[®]

Because life is powered by water[®]



Hard Water Finisher		Hard water
<p>Peters Excel Hard Water Finisher is developed for application in hard irrigation water. It is ideal for plants requiring controlled and compact growth. Thanks to the N:K ratio of 1:2, it is suitable in cases of relatively high levels of nitrogen in the irrigation water. Peters Excel Hard Water Finisher acidifies the irrigation water and neutralises bicarbonate</p>		
Code	Analysis	Pack Size
PETERS/02	14-10-26+2MgO+TE	15kg



Hard Water Grow Special		Hard water
<p>Peters Excel Hard Water Grow Special is developed to encourage growth in situations in which hard irrigation water is used. It has an acidifying effect on the irrigation water and neutralises bicarbonate. Peters Excel Hard Water Grow Special ensures a stable pH level in the soil.</p>		
Code	Analysis	Pack Size
PETERS/06	18-10-18+2MgO+TE	15kg



Extra Acidifier		Hard water
<p>Peters Excel Extra Acidifier is developed for application in hard irrigation water with high levels of bicarbonate. This Peters Excel product has a stronger acidifying effect than other Peters Excel acidifiers. Additional acidification of the water may sometimes be necessary, depending on the bicarbonate levels.</p>		
Code	Analysis	Pack Size
PETERS/04	15-14-25+TE	15kg



Fertiliser, Liquid Feeds & Plant Health Stimulants

Water Soluble Fertiliser

1-1-1		
For general horticultural use to maintain plant nutrition levels and promote healthy growth. Suitable for most crops in most situations.		
Code	Analysis	Pack Size
SOLUFEED/03	18:18:18+3+te	20kg



Solufeed Superior Fleury		
An acidifying, finishing feed which helps overcome the difficulties associated with high pH water with high bicarbonate levels.		
Code	Analysis	Pack Size
SOLUFEED/20	13:10:28+2+te	20kg



1-5-1		
To encourage vigorous root growth and good plant establishment. Suitable for most crops in most situations and typically used early in the season when plants are young.		
Code	Analysis	Pack Size
SOLUFEED/04	10:52:10+1+te	20kg



Solufeed Superior Vigil		
An acidifying and balanced starter water soluble fertiliser which helps overcome the difficulties associated with high pH water with high bicarbonate levels.		
Code	Analysis	Pack Size
SOLUFEED/22	16:10:18+2+te	20kg



2-1-4		
To promote flowering and subsequent fruit production. Improves flavour and increases sturdiness of plants and shelf-life of fruit.		
Code	Analysis	Pack Size
SOLUFEED/05	15:07:32+3+te	20kg



Solufeed H		
Flexible hydroponic fertiliser for creating the "B" tank along with grower-sourced potassium nitrate.		
Code	Analysis	Pack Size
SOLUFEED/12	00:17:29 +11+te	17.5kg



4-1-2		
A high nitrogen feed to encourage vigorous vegetative growth and good leaf colour.		
Code	Analysis	Pack Size
SOLUFEED/06	28:07:14+3+te	20kg



Solufeed F		
The original hydroponic feed, and suitable for virtually any crop capable of being grown hydroponically. Contains N, P, K, Mg and trace elements.		
Code	Analysis	Pack Size
SOLUFEED/10	09:07:37+5+te	20kg



Trace Elements

Micromax Premium 		
Micromax Premium is a fine granular fertiliser with trace elements. These are essential in order to obtain optimum plant growth. Micromax Premium ensures that the plant receives all the sufficient amounts of trace elements it requires. The unique formula increases the efficiency of the major elements.		
Code	Analysis	Pack Size
TRACE/02	B+Cu+Fe+Mn+Mo+Zn	25kg



Solufeed Tec		
An advanced, carefully formulated and fully chelated micronutrient source, without sodium, for modern hydroponics systems and foliar feeding.		
Code	Analysis	Pack Size
SOLUFEED/27	B+Cu+Fe+Mn+Mo+Zn	10kg



Micromax Fe 		
MicroMax WS Iron is a premium fully water-soluble fertiliser, consisting of EDDHA-chelated iron plus X3, a specific bio stimulant that enhances the absorption of the Fe-chelate compound into plant leaves resulting in optimum uptake by a large variety of crops.		
Code	Analysis	Pack Size
MICRO/01	6% Fe	5kg



Micromax WS TE Mix 		
MicroMax WS TE is a premium fully water-soluble trace element mix, consisting of all major trace-elements (TE), whereby all cationic ones are present in chelated form.		
Code	Analysis	Pack Size
MICRO/02	B+Cu+Fe+Mn+Mo+Zn	5kg

Librel® & Solufeed Chelates		
Code	Analysis	Pack Size
Librel® Fe-Lo	1kg & 25kg	13.2% EDTA iron chelate. For soils and hydroponic solutions below pH 6.5 and for foliar spraying.
Fe 7 DTPA	1kg	7% DTPA iron chelate. For moderately alkaline soils of up to pH 7.5 and Hydroponics.
Librel® Fe-DP	25kg	7% DTPA iron chelate. For moderately alkaline soils of up to pH 7.5 and Hydroponics.
Librel® Fe-Hi	1kg & 20kg	7% EDDHA iron chelate. For use on soils, especially effective on soils with pH>7.5: Regular grade.
Librel® Ca	1kg & 25kg	9.5% EDTA calcium chelate. For foliar spraying and for adding to soil without increasing pH.
Librel® Cu	1kg & 25kg	14% EDTA chelated copper. For foliar spraying and all soils.
Librel® Mg	1kg & 25kg	5.5% EDTA chelated magnesium. Ideal for Hydroponic systems, fertigation and for foliar spraying.
Librel® Mn	1kg & 25kg	13% EDTA chelated manganese. Ideal for Hydroponic systems, fertigation and for foliar spraying.
Librel® Zn	1kg & 25kg	14% EDTA chelated zinc. Use for Hydroponic systems, fertigation and for foliar spraying.



Fertiliser, Liquid Feeds & Plant Health Stimulants

Straight Fertilisers

CALCINIT Soluble grade calcium nitrate		
A fully water soluble nitrogen and calcium fertiliser. It is a free flowing, fine granular or prilled material which dissolves quickly in water.		
Code	Analysis	Pack Size
CALC/03B	15.5% n + 26.3% CaO	25kg



KRISTA K PIUS Soluble grade potassium nitrate		
YaraTera KRISTA-K-PLUS is a free flowing nitrogen and potassium fertiliser which dissolves quickly in water without any residue.		
Code	Analysis	Pack Size
POTASSIUM/03B	13.7-0-46.3	25kg



KRISTA MAG Soluble grade magnesium nitrate		
YaraTera KRISTA-Mag is a free flowing nitrogen and magnesium fertiliser which dissolves quickly in water without any residue.		
Code	Analysis	Pack Size
MAGN-N	11% N + 15% MgO	25kg



KRISTA MGS Soluble grade magnesium sulphate		
YaraTera KRISTA-MGS is a free flowing sulphur and magnesium fertiliser which dissolves quickly in water without any residue.		
Code	Analysis	Pack Size
MAGN/02B	16%MgO+13%S	25kg



KRISTA MKP Soluble grade Mono potassium phosphate		
YaraTera KRISTA MKP is a free flowing, fine crystalline powder containing phosphorus and potassium which dissolves quickly in water.		
Code	Analysis	Pack Size
MONO/02B	0-52-34	25kg



KRISTA SOP Soluble grade potassium sulphate		
YaraTera KRISTA SOP is a free flowing, fine crystalline powder containing potassium and sulphur which dissolves quickly in water.		
Code	Analysis	Pack Size
POTASH/04	0-0-51+18S	25kg



KRISTA MAP Soluble grade Mono ammonium phosphate		
YaraTera KRISTA MAP is a free flowing, fine crystalline powder containing nitrogen and phosphorus which dissolves quickly in water.		
Code	Analysis	Pack Size
MONO/01	12-61-0	25kg



KRISTA MOP Soluble grade potassium chloride		
YaraTera KRISTA MOP is a free flowing, fine crystalline powder containing potassium chloride which dissolves quickly in water.		
Code	Analysis	Pack Size
POTASSIUM/04	0-0-60	25kg



Fertiliser, Liquid Feeds & Plant Health Stimulants

KRISTA CaCl Soluble grade calcium chloride		
A fully water soluble calcium fertiliser for use as a calcium source in hydroponics and fertigation.		
Code	Analysis	Pack Size
CALC/02	28%Ca 50%Cl	25kg



KRISTA Urea Soluble grade nitrogen		
A fully soluble urea based nitrogen fertiliser.		
Code	Analysis	Pack Size
UREA/02	46-0-0	25kg



TROPICOTE Field grade calcium nitrate		
A high quality calcium nitrate product for field application. It is a dense granular fertiliser that spreads accurately up to 24 metres by machine or accurately when placed by hand.		
Code	Analysis	Pack Size
CALC/035	15.5%N + 26.3%Ca	25kg



Amnitra L		
A liquid nitrogen fertiliser containing ammonium nitrate solution suitable for application through all fertigation systems .		
Code	Analysis	Pack Size
AMMO	18% N	20lt

PG Mix		
Yara PG Mixes are all-in-one powdered compound fertiliser for potting ordinary peat into high standard potting soil. PG Mix removes the burden of mixing straights and provides even distribution of nutrients in the potting medium.		
Two mixes available, 12-14-16 and 14-6-18.		
Code	Analysis	Pack Size
PG-MIX/01	12-14-24+2MgO+Te	25kg
PG-MIX/02	14-16-18 0.8MgO+Te	25kg

Magnitra		
A quality liquid nitrogen and magnesium fertiliser containing magnesium nitrate suitable for application through all fertigation systems.		
Code	Analysis	Pack Size
MAGNITRA/01	7%N + 10%MgO	27kg

Calsal		
A liquid nitrogen fertiliser containing calcium nitrate suited to application through all fertigation systems .		
Code	Analysis	Pack Size
CALSAL/01	8.7%N + 17.5% CaO	1500kg

Fertiliser, Liquid Feeds & Plant Health Stimulants

Straight Fertilisers

Mono Ammonium Phosphate		
Nova MAP 12-61-0, mono ammonium phosphate is ideal for use in the initial growth phase of all crops , immediately before and after seeding and planting/ transplanting.		
Code	Analysis	Pack Size
MONO/01B	12-61-0	25kg



Sulphate Of Potash		
Nova SOP 0-0-50+43SO3 is the Potassium Sulphate from the ICL Specialty Fertilisers. It is one of the common source of Potassium based fertiliser used in hydroponics. The product is indicated to be used in any fertigation system.		
Code	Analysis	Pack Size
POTASH/04B	0-0-50+43SO3	25kg



Pekacid		
Nova PeKacid 0-60-20 is a patented water-soluble PK fertiliser which is ideal for open-field and soilless crops. The product can be used in both hard-water conditions and calcareous soils.		
Code	Analysis	Pack Size
PEKA	0-60-20	25kg



Nova Mag-S 0-0-0+16MgO+32SO3 is ICL SF' Magnesium Sulphate fertiliser providing fully soluble and high purity nutrients, dissolving quickly in water		
Code	Analysis	Pack Size
MAGN/02	0-0-0+16MgO+32SO3	25kg



Potassium Nitrate		
Nova N-K 13.5-0-46 is the Potassium Nitrate from the ICL Specialty Fertilisers. The product provides a highly efficient source of Nitrogen and Potassium, dissolving quickly in water.		
Code	Analysis	Pack Size
POTASSIUM/03	13.5-0-46	25kg



Calcium Nitrate

Nova Calcium is the Calcium Nitrate within the Nova range. Nova Calcium will help to maintain an optimum level of Calcium in the plant and will prevent or correct any deficiencies.



Code	Analysis	Pack Size
CALC/03	15.5-0-0+27CaO	25kg

Potassium Chloride

Nova Ferti-K 0-0-61 is the ideal product for Chloride tolerant crops. It is the richest Potassium fertiliser though the least expensive one.



Code	Analysis	Pack Size
POTASSIUM/02	0-0-61	25kg

Mono Potassium Phosphate

Nova PeaK 0-52-34, mono potassium phosphate, is produced by ICL Specialty Fertilisers, the largest manufacturer of MKP worldwide.



Code	Analysis	Pack Size
MONO/02	0-52-34	25kg

Seaweed Fertilisers

Maxicrop Original

A pure seaweed extract containing 8% (W/W) soluble seaweed solids including a wide range of plant growth stimulants and trace elements present in all extracts.



Code	Analysis	Pack Size
MAXI/06	8% soluble seaweed	10lt

Maxicrop Tomato Special

A potassium enriched seaweed extract and fertiliser that provides bio-stimulant benefits alongside the right mix of nutrients for effective growth.



Code	Analysis	Pack Size
MAXI/08	5.1-5.1-6.7	10lt

Maxicrop Plus Iron

A seaweed extract formulated with 2% iron in a readily available sequestered form.



Code	Analysis	Pack Size
MAXI/04	2% Fe	10L

Maxicrop Triple

A concentrated formulation of seaweed extract containing 25.6% soluble solids and a wide range of trace elements.



Code	Analysis	Pack Size
MAXI/09	3:1:3 + 25.6% Soluble Seaweed	10lt

Foliar Nutrition

CalMax® Ultra

CalMax Ultra is a unique formulation containing calcium and AXM, which acts as a 'pump primer' to ensure calcium is effectively transported into plant cells even during periods of low metabolic activity. The increased leaf and fruit calcium allows for longer storage life and less risk of physical damage as well as a greater resilience to physiological breakdown.

Calmax Ultra Protects against Blossom End Rot, Bitter Pit, Tip Burn and other calcium related disorders and also increases fruit firmness leading to improved storability and shelf life.

Code	Analysis	Application Rate	Pack Size
FOLIAR/02	N12% CaO21.8%	1-3lt/Ha	5lt



Bio 18

Bio 18 provides the benefits of naturally occurring kelp and a balanced combination of macro and micro nutrients. The biostimulants and nutrients found in Bio 18 improve root growth and nutrient uptake to a greater level than when the two are applied separately. Bio 18 can be used to the best effect when the crop is under stress but specific deficiencies should be treated with the relevant foliar product.

Bio18 should be used as a specialised foliar feed and plant growth stimulant for plants requiring extra iron, particularly in times of stress.

Code	Analysis	Application Rate	Pack Size
BIO18	N18 P18 K18	2-3lt/Ha	10lt



Foliar Supreme

Use Foliar Supreme as part of a nutrient management programme or when results from SAP analysis show low or deficient levels of phosphate, potash or sulphur. Foliar uptake will be enhanced by the addition of SW7¹.

Code	Analysis w/v (%)	Application Rate	Pack Size
FOLIAR/02	P24 K15 S45 SO3 112.5	2-4lt/Ha	1lt
FOLIAR/01	P24 K15 S45 SO3 112.5	2-4lt/Ha	10lt



Bio 20

Bio 20 provides the benefits of naturally occurring kelp and a balanced combination of macro and micro nutrients. The biostimulants and nutrients found in Bio 20 improve root growth and nutrient uptake to a greater level than when the two are applied separately. Bio 20 can be used to best effect when the crop is under stress. However specific deficiencies should be treated with the relevant foliar product.

Bio 20 should be used as a general foliar feed and plant growth stimulant, particularly in times off stress.

Code	Analysis	Application Rate	Pack Size
BIO20	N20 P20 K20	0.5-3lt/Ha	10lt



Fertiliser, Liquid Feeds & Plant Health Stimulants

Vitomex

A unique nitrate free foliar nutrient which supplies plant stimulating phosphite along with potassium and trace elements chelated in a unique way to improve plant health and tolerance of abiotic stress.

Use Vitomex as directed below. Foliar uptake will be enhanced by the addition of NA13 unless in tank mix with a pesticide, NA13 is recommended if the target is small or the canopy is dense.

Code	Application Rate	Water Volume	Pack Size
VITO5	2-4lt/Ha	200-600lt/Ha	5lt
VITO10	2-4lt/Ha	200-600lt/Ha	10lt



Liquid Seaweed

Kelpak

To enhance root growth which improves crop establishment leading to higher yield and better quality. Kelpak helps to increase plant tolerance to abiotic stress and improves pollen germination, pollen tube growth, fertilisation and fruit set.

Code	Pack Size	Application Rate	Water Volume
KELPAK/01	1lt	2-3lt/Ha	200-600lt/Ha
KELPAK/02	5lt	2-3lt/Ha	200-600lt/Ha
KELPAK/03	25lt	2-3lt/Ha	200-600lt/Ha



Zynergy

This specially formulated combination of highly available copper and zinc is designed to form a key part of an integrated crop management programme to boost crop health and maximise yield potential.

Use Zynergy when deficiency is diagnosed or as a regular maintenance treatment in conjunction with crop protection programmes during periods of rapid growth and fruit, grain or root formation. Foliar uptake will be enhanced by the addition of NA13 unless in a tank mix with a pesticide.

Apply at 1-2 ml/l water (1-2 l/ha), in 200-1000 l/ha water.

Code	Application Rate	Water Volume	Pack Size
ZYNERGY	1-2lt/Ha	200-1000lt/Ha	5lt



Basfoliar® Kelp

This biostimulant is a natural extract of the brown algae Ecklonia Maxima, containing natural phytohormones, proteins and aminoacids for enhanced root growth, plant establishment and stress relief. Typical application: 0.2- 1% in the form of foliar spraying.

- Green in colour
- Contains essential Auxins and Cytocenis

Code	Pack Size	Analysis	Application Rate
BASF/02	10lt	9-1.6-0.1+Te	10lt/ha



Immunological Activators - Winner Of Four Oaks Best New Product 2019

Primtal immunological activators nourish and preserve the health of the crop in a way compatible with the environment and humans.

Like humans, plants have an inbuilt immune system that is activated in response to attack by disease. In nature this enhanced immunity can be triggered by a number of stimuli for example by pathogens attacking a plant, also some beneficial microbes can switch on plants natural defences. Certain stresses are also often chronologically linked, a preceding stress may be a “warning” cue of upcoming future stress e.g. the presence of insect eggs on leaves is a pre-cursor to insect attack. By priming the plant before an attack happens the response is faster and more intense. Airtal Immunological Activators activate or prime these self defence mechanisms.

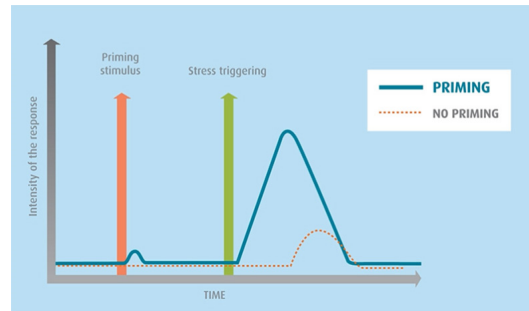

How does a plant fight off diseases ?

Plants have a number of mechanisms to fight off or repel disease and Airtal Immunological Activators activate multiple mechanisms.

Chemical Barriers

Repellence: Through the production of volatile compounds.

Antibiosis: Through the production of compounds detrimental to an attacking organism.

Physical Barriers

Strengthening: Re-enforcing cell walls to prevent penetration by fungal hyphae.

Physiological: Reduced opening of stomata. Changes to trichomes (hairs).

Primtal FG

Primtal FG is an immunological activator containing plant metabolites that have been specifically selected to influence the secondary metabolism of plants in situations of stress due to fungal attack.

Primtal FG primes the plant’s natural defences in readiness against fungal attack causing the plant to react faster and with higher intensity.

- A faster and more intense response to fungal attack
- Activates multiple defence mechanisms
- No energy cost to the plant - no check to growth
- Does not generate resistance in crops
- Compatible with biological control
- Zero residues



Application rates

Foliar: 2-2.5 litres per hectare or 200-300ml per 100 litres of water sprayed to run off every 7-10 days.

Root: 2.5-3 litres per hectare applied through drip irrigation or drench every 7-10 days.

Code	Description	Pack Size
PRIMTALFG1	Defence against fungal attack	1lt
PRIMTALFG5	Defence against fungal attack	5lt

Primtal WF

Primtal WF is an immunological activator containing plant metabolites that have been specifically selected to influence the secondary metabolism of plants in situations of stress due to sucking insects.

Primtal WF primes the plant's natural defences against sucking insects causing the plant's natural defence to be faster and more intense.

- Activates multiple defence mechanisms
- A faster and more intense response to sucking insect attack
- No energy cost to the plant - no check to growth
- Does not generate resistance in crops
- Compatible with biological control
- Zero residues



Application rates

Foliar: 1-1.5 litres per hectare or 100-200ml per 100 litres of water sprayed to run off every 7-10 days.

Root: 1.5-2.5 litres per hectare applied through drip irrigation or drench every 7-10 days.

Code	Description	Pack Size
PRIMTALWF1	Defence against sucking pests	1lt
PRIMTALWF5	Defence against sucking pests	5lt

Primtal RS

Primtal RS is an immunological activator containing plant metabolites specifically selected to help trigger a plant's natural defence against mites.

- Activates multiple defence mechanisms
- A faster and more intense response to mite attack
- Does not generate resistance in crops
- Compatible with biological control
- No energy cost to the plant - no check to growth
- Zero residues



Application rates

Apply by drip irrigation or pot drench

Ornamentals: 2-3 litre pots, 1ml in enough water to drench 100 pots

Vegetables: 2.5-3 litres per hectare every 7-10 days.

Fruit Trees: 2.5-3 litres per hectare every 10-15 days.

Code	Description	Pack Size
PRIMTALRS1	Defence against mites	1lt
PRIMTALRS5	Defence against mites	5lt

Compost Tea

ReviTEALised Compost Tea

An aerobic bio stimulant or compost tea. It is blended from several different sources of carefully composted ingredients including some worm cast compost. It is blended to give a more diverse range of Bacteria, Fungi and Protozoa than green matter compost alone, which helps in the suppression of a wider range of diseases.

In simple terms it is a pro-biotic for plants. It works by boosting the good biology (Bacteria, Fungi and Protozoa) that should be present both on the plants surfaces (leaves and roots) and in the soil, thus allowing all the processes and interactions in the soil food web to function as they should.

Diseases are suppressed by making sure there are beneficial organisms there to occupy any infection site on the plant and to then out compete incoming disease causing organisms. The beneficial organisms will also consume the food sources supplied by the plant thus denying any incoming disease causing organism an easy meal.

ReviTEALised is supplied in a concentrated form. All you need is a simple brewer to extract and grow the "good" biology. Then you just dilute your concentrated tea with water and spray or water it on like a liquid feed or pesticide.

- Suppresses disease
- Makes plants more resistant to attack from fungal diseases
- Reduces nutrient leaching
- Improves water retention

Code	Pack Size	Dosatron Setting	Mist Blowers	Application Rate
REVI/01	2.5kg	1:100	Apply neat. 2.5lt/500m2	1lt/Ha
REVI/02	6kg	1:100	Apply neat. 2.5lt/500m2	1lt/Ha

ReviTEALised Brewing Machine

What a compost tea brewer does is to deliver lots of air to the liquid brew which will raise the oxygen level of the brew water and so provide high levels of oxygen to the culture starter so that the beneficial organisms, fungi and protozoa, increase and multiply at a massive rate. 24 hours of brewing is usually sufficient but longer periods are desirable in cold weather. The resultant culture concentrate (compost tea) is then diluted, usually at 1 in 100, and applied through a sprayer onto the turf.

The XL ProBio Compost Tea Brewing machines have been designed to be a cost effective way to get into Compost Tea Brewing. They are all easy to keep clean and they deliver the maximum amount of air to the liquid in small highly effective bubbles.

Ensure your brewer is 100% clean before use
Quick transfer pump for 200lt brewer available

- Brewer codes (Size)
- BREWER-50 (50lt)
- BREWER-250 (250lt)



Kg of ReviTEALised Concentrate	Brew Size
2	20lt
2.5	50lt
3	100lt
5	225lt
6	450lt
9	2200lt



Biolift Plant Health

BioLift is an instant, ready and easy to use liquid biology additive for use with all growing mediums and is derived from totally organic products with no chemical additives. Simply open the can and use! It has much more microbial activity (per litre) than any other compost tea on the market.

It is used on plants or areas that have had high levels of chemicals applied and/or where there is a high level of disease or toxicity. It will rejuvenate natural disease suppressants in the substrate.

How does Biolift work?

- Adds a beneficial SRD (species rich diversity) biology to your soil community
- Reduces chemical and fertiliser inputs
- Suppresses parasitic nematodes, fusarium and leaf spot diseases
- Promotes quicker root development of newly planted species
- Enhances germination of newly sown crops
- Releases plant nutrients naturally, reducing fertiliser costs
- Helps convert macro and micro nutrients and aids in effective uptake of fertilisers, lengthening periods between fertiliser applications
- Improves stress resistance
- Assists foliar and root disease suppression
- Promotes increased rooting



Code	Pack Size	Application Rate
BIOLIFT/02	10lt	10lt/Ha

BioStim HFT

Beneficial soil organisms lack the ability to photosynthesise and capture energy from the sun. They therefore have to survive on residual carbon substances in the soil. BioStim HFT is therefore a good source of energy for all the beneficial soil organisms providing the carbon energy and many mineral requirements for soil micro organisms as a substitute for photosynthesis.

- Stimulates early growth (soil temperature above 5°C)
- Increases the permeability of cell-membranes in the root which increases nutrient uptake
- Promotes the development of chlorophyll, sugars and amino acids in the plant leading to better photosynthesis
- Stimulates plant growth by accelerating cell division and increasing the rate of development in root systems
- Enhances cationic exchange capacity in the soil
- Acts as a natural chelator and increases nutrient availability for plants
- Decreases stress by drought and application of plant treatments
- Decreases high salt content in soils and thus the resulting toxicities
- Source of energy for beneficial fungi-bacteria-mycorrhizae and protozoa found in ReviTEALised and Biolift turf



Code	Pack Size	Application Rate
BIOSTIM	1lt	1lt/Ha

Foliar Nutrition

Basfoliar® Aktiv

Beside potassium and the complete range of micro nutrients this fertiliser product contains phosphorous in the form of phosphoric acid. As a promoter of root growth and a quality enhancer it also contains natural algae extract derived from Seaweed (Auxins 1.1 mg and Cytocenis 0.003 mg). The product can be applied either via foliar spraying, irrigation or direct application to the soil.

- Contains essential Auxins and Cytocenis
- Contains phosphorus in the form of phosphoric acid



Code	Analysis	Application Rate	Pack Size
BASF/01	3-27-18+Te	10lt/ha	10lt



- Only fertiliser to contain every essential plant nutrient in soluble form including Calcium
- Will stimulate beneficial microbial growth (organic acids)
- Low application rate of 2-4ml / litre of water
- Ideal as a hydroponic fertiliser 2ml/litre of water
- 9-5-16 Analysis
- Pack Size 1lt & 5lt

Disorders caused by Calcium deficiency

- Strawberry: tip burn, malformed (cupped) leaves, and small malformed and insipid fruit
- Tomato, Pepper, Melon: blossom end rot
- Poinsettia: bract necrosis

Code	Analysis	Application Rate	Pack Size
GOLDLEAF/01	9-5-16	2-4ml/ 1lt water	1lt
GOLDLEAF/02	9-5-16	2-4ml/ 1lt water	5lt

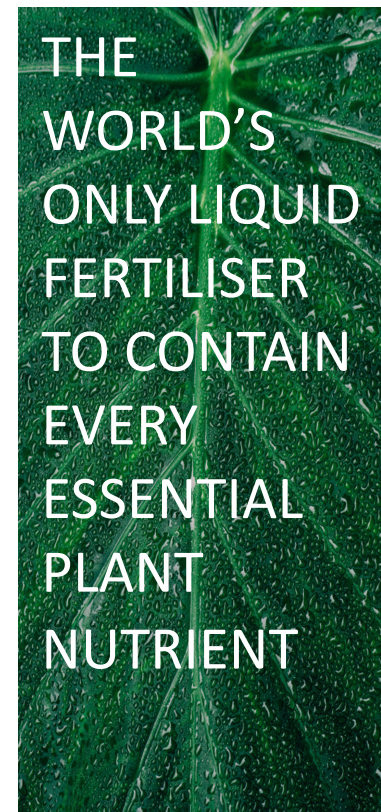

Adjuvants

SW7		
SW7 is a silicon based wetter designed to improve uptake of plant protection products and foliar nutrients on crops that are difficult to achieve good coverage, with waxy or tight layers of leaves or dense canopies.		
<ul style="list-style-type: none"> • ADJ A0875 		
Code	Pack Size	Application Rate
SW7	1lt	0.05-0.1% total solution volume = 0.5 to 1.0ml per litre of water applied



Mixture B			
Mixture B is a non-ionic wetter/spreader, which greatly enhances the effect of glyphosate. When used it cuts away the waxy layer on plant leaves which increases the uptake of the glyphosate into the plant. Particularly useful when treating bracken, Japanese knotweed, brush wood weeds, sow thistle and others.			
Code	Pack Size	Application Rate	Knapsack rate
MIXT	5lt	2% of spray volume when using glyphosate	200ml in 10lt of water



Kobra		
Kobra is a fatty amine based wetter designed to give enhanced coverage and consequent uptake of agrochemicals and foliar nutrients when used as a foliar adjuvant. The improved coverage means drying time is usually 50% quicker than agrochemicals alone.		
<ul style="list-style-type: none"> • Enhanced coverage & uptake • 50% Quicker drying time than similar products 		
Code	Pack Size	Application Rate
KOBRA	5, 200 & 1000lt	10-500ml per 1000lt water



Activator 90			
Non-ionic wetting agent which is designed to improve the performance of pesticides. Activator 90 has a built-in anti-foam/defoamer and reduces drift. There is no risk of over wetting and run-off.			
Code	Pack Size	Application Rate	MAPP: ADJ0547
ACTI	5lt	Knapsack: 10ml per 10lt of water Boom: 0.1% spray solution	Knapsack: 10ml per 10lt of water Boom: 0.1% spray solution



Fungicides



Horticultural Fungicides					
Product	Code	Active Ingredient	Description	Pack Size	MAPP No
Amistar	AMIS	Azoxystrobin	A broad spectrum fungicide with systemic, translaminar and protectant properties for use in various edible and ornamental crops. Best used during periods of growth.	5lt	18039
AQ10	AQ10	Ampelomyces quisqualis strain AQ10	AQ10 is a biopesticide which provides powdery mildew reduction in a range of protected crops including cucumber, strawberries and tomatoes.	30g	15518
Nimrod	NIMROD	Bupirimate	Nimrod is a systemic fungicide providing curative and protectant activity against powdery mildew on both top and soft fruit. Also suitable for use on Ornamentals.	1lt	18522
Contans	CONT/01	Coniothyrium minitans strain CON/M/91-08	Contans WG breaks the cycle of Sclerotinia diseases that can significantly reduce yields in horticultural crops. Contans WG is approved for use on all edible and non-edible crops.	4kg	17985
Frupica	FRUP	Mepanipyrim.	Frupica is for the control of Botrytis Cinera in outdoor and protected strawberries.	1lt	12067
Prestop	PRESTOP PRESTOP/01	Gliocladium catenulatum Strain J1446	Prestop has proven efficacy against Damping-off diseases - Botrytis, Pythium, Phytophthora, Rhizoctonia, Fusarium; Root and Base Rot diseases - Pythium, Phytophthora, Rhizoctonia, Fusarium; Aerial diseases - Botrytis, Didymella (Mycosphaerella).	1kg 5Kg	17223
Promess	PROM	Propamocarb hydrochloride	Semi-systemic fungicide for the prevention of damping-off, root and stem rot, leaf blight and downy mildew.	1lt	16008
Previcur Energy	PREVI	Propamocarb and fosetyl	A systemic multi-site fungicide for the control of downy mildew on protected and outdoor crops .	1lt	15367
Serenade ASO	SERAN	Bacillus subtilis (strain QST 713)	A powerful tool designed to protect against the effects of soil and foliar bacterial and diseases. Directly attacks diseases in the soil including Pythium , Rhizoctonia, Fusarium and Botrytis.	10lt	16139



For more information on label authorisations & extensions of authorisation visit: <https://secure.pesticides.gov.uk/pestreg/ProdSearch.asp>

Fungicides



Horticultural Fungicides					
Product	Code	Active Ingredient	Description	Pack Size	MAPP No
Signum	SIGN	Boscalid and Pyraclostrobin.	Signum is a fungicide with protectant and systemic activity for use against certain diseases in broccoli, brussels sprout, cabbage, calabrese, cauliflower, strawberry (outdoor and protected), carrot, lettuce (outdoor and protected), field beans, vining peas and blackcurrants.	2.5kg	11450
Subdue	SUBDUE	Metalaxyl-M	A systemic fungicide with protective and curative activity for the control of Pythium spp. and Phytophthora spp. (root rot diseases) in outdoor and protected ornamental crops and flower bulbs. Subdue is to be applied as a drench or incorporated into soil or growing media.	250ml	12503
Switch	SWIT	Cyprodinil and fludioxonil	A co-formulation of cyprodinil and fludioxonil for the control of a range of diseases, including some leaf spots, botrytis and sclerotinia in ornamental plant production and in a range of both vegetable and fruit crops.	1kg	15129
T34	T34/01 T34/02	Trichoderma asperellum strain T34	Biofungicide for growing media treatment. For reduction of Fusarium oxysporum f. sp.dianthi on carnations and Pythium on tomato, pepper, chilli and aubergine. EAMUs for other crops.	250g 500g	17290
Takumi	TAKUMI	Cyflufenamid	A suspension concentrate formulation containing 100g/l cyflufenamid. For the control of powdery mildew on courgette, cucumber, melon and summer squash, with EAMUs for use on ornamentals, tomatoes and strawberries.	150ml	16000

Fungicides For Turf					
Product	Code	Active Ingredient	Description	Pack Size	MAPP No
Instrata Elite	INST/02	Difenoconazole and fludioxonil	Instrata Elite gives a powerful combination of curative and contact plus systemic properties, for reliable turf protection outside and in the plant.	3lt	17976
Inter Tebloxy	INTER	Tebuconazole and trifloxystrobin	Inter Tebloxy has preventative and curative action against many common turf diseases in amenity turf. Can be used all year round.	1lt	17311
Medallion	MEDA	Fudioxonil	Medallion TL is a fast acting Contact+ fungicide designed for use in winter.	3lt	15287

Insecticides

Horticultural Insecticides					
Product	Code	Active Ingredient	Description	Pack Size	MAPP No
Applaud	APPLAUD	buprofezin	A suspension concentrate formulation for use as an insecticide for the control of glasshouse and tobacco whitefly.	1lt	17196
Conserve	CONS	spinosad	Conserve is a selective insecticide for the control of western flower thrip in protected ornamental plant production and protected crops of cucumber, tomato, pepper and aubergine.	1lt	12058
Decis Protech	DECIS	deltamethrin	A broad spectrum pyrethroid insecticide for the control of aphids, caterpillars and other pests in a wide range of agricultural and horticultural crops.	1lt	16160
Dipel DF	DIPEL	bacillus thurengiensis var kurstaki	An organic insecticide for the control of caterpillars on fruit, vegetable and ornamental crops.	500g	17499
Dynamec	DYNA	abamectin	An approved professional contact and translaminar insecticide & acaricide for control of two-spotted spider mite, leafminer (<i>Liriomyza</i> spp.) and thrips including western flower thrips.	250ml	18316
Flipper	FLIPPER	fatty acids C7-C20	A highly effective broad-spectrum contact insecticide/acaricide to control whitefly, aphids and spider mites on protected crops of tomatoes, cucumbers and strawberries.	10lt	17767
Floramite	FLORA	bifenazate	Floramite is a suspension concentrate for use as a selective acaricide on protected strawberries for control of the two-spotted spider mites.	250ml	13686
Gazelle SG	GAZE	acetamiprid	A broad spectrum insecticide with systemic and translaminar activity on aphids, whitefly and other chewing and sucking pests in a range of edible and ornamental crops.	500g	13725



For more information on label authorisations & extensions of authorisation visit: <https://secure.pesticides.gov.uk/pestreg/ProdSearch.asp>

Insecticides

Horticultural Insecticides					
Product	Code	Active Ingredient	Description	Pack Size	MAPP No
Majestik	MAJE	Maltodextrin	A fast acting, contact pesticide in a soluble concentrate formulation containing Maltodextrin for the control of spider mites in all outdoor and protected crops.	5lt	17240
Pyrethrum 5EC	PYRE	Natural pyrethrins	A natural organic insecticide for the control of a wide range of insects including aphids, caterpillars, thrips, spider mites, leaf hopper, whitefly on a wide range of crops.	1lt	12685
SB Plant Invigorator	SBPI/01 SBPI/02	Carbonic acid diamide/urea	SB Plant Invigorator is an environmentally friendly pesticide, mildewcide and foliar feed for use on all edible and ornamental crops, available as a concentrate for larger areas.	1lt 5lt	-
Sequoia	SEQ	Sulfoxaflor	With systemic and translaminar action, Sequoia is approved for the control of aphids and whitefly in a range of protected crops.	250ml	18938
Sluxx HP	SLUXX	Ferric phosphate	Environmentally friendly and economical slug pellet.	20kg	16571
Spruzit	SPRUZIT	Pyrethrins	An emulsifiable concentrate, containing 4.59 g/litre pyrethrins, for use against biting and sucking insects in edible and non-edible plants grown in outdoor and protected situations.	10lt	18434
Steward	STEWARD	Inoxacarb	For the control of caterpillars in cabbage, cauliflower, broccoli, apples, pears and various protected fruiting vegetables.	250g	18792
Tec-Bom	TEC-BOM	Potassium Salts of Fatty Acids	A powerful, biodegradable contact insecticide. Dissolves the exoskeleton of soft-shelled insects, by altering cell membranes causing death by suffocation and dehydration. For use on aubergine, pepper and tomato.	5L	19547

Herbicides

Total Herbicides - Kill all green-leaved plants					
Product	Code	Active Ingredient	Description	Pack Size	MAPP No
Roundup ProActive	ROUN/01	360gl / glyphosate	A highly active glyphosate formulation for use in a wide range of areas.	5lt	17380
Roundup ProVantage	ROUN/02	480gl / glyphosate	A high load, clean label premium glyphosate that offers outstanding value for money.	5lt	15543
Amenity Glyphosate	MONS	360gl / glyphosate	A cost-effective glyphosate formulation for the control of emerged weeds.	5lt	16382
New Way Weed Spray	NEWW	Acetic acid	The first natural total herbicide for hard surfaces in the UK.	5lt	15319
Paradise	PARA-50/01 PARA-150/01	Flazasulfuron	Offers long term residual action on areas not intended to bear vegetation, hard surfaces and amenity vegetation (around).	50g 150g	16829

Selective Herbicides - Kill all none grass weeds					
Product	Code	Active Ingredient	Description	Pack Size	MAPP No
Pan Isoxaben	PANI	Isoxaben	A pre-emergent herbicide with residual activity, designed to control many broad leaved weeds in amenity vegetation, ornamental plant production and forestry before they emerge.	500ml	18419
Kerb Flo 400	KERB400	Propyzamide	A residual herbicide that can be used as a pre or post-emergence weed killer in forestry and amenity plantings.	5lt	13716
Icade	ICADE	Aminopyralid and triclopyr	Icade can be used for the control of invasive and tough woody weeds including Japanese Knotweed, Hogweed and Budlea.	1lt	16182
Grazon Pro	GRAZON	Triclopyr and clopyralid	A selective weed killer for the control of nettles, docks , thistles , bramble, broom and gorse in grassland.	1lt	15785
Depitox	DEPITOX/01	2,4-D	Depitox is a selective herbicide for many weeds (including ragwort) in grassland.	5lt	13258
Enforcer	ENFOR	Dicamba / MCPA / mecoprop-P	Enforcer is a herbicide for broad-leaved weeds in managed amenity turf.	5lt	17274
Praxys	PRAXYS	Fluroxypyr / clopyralid / florasulam	Praxys is a high performance, highly concentrated systemic weedkiller.	2lt	13912



For more information on label authorisations & extensions of authorisation visit: <https://secure.pesticides.gov.uk/pestreg/ProdSearch.asp>

Plant Growth Regulators, Rooting Hormones

Growth Regulators					
Product	Code	Active Ingredient	Description	Pack Size	MAPP No
Bonzi	BONZI	Paclobutrazol	Bonzi regulates vegetative growth and produces a more sturdy, compact plant. Can enhance flowering, shelf life and colour.	1lt	17576
B Nine	BNINE	Daminozide	A Plant Growth Regulator for protected ornamental plant production, resulting in compact and robust plants more able to withstand stress.	1kg	14434
Dazide Enhance	DAZIDE	Daminozide	Dazide Enhance produces a more compact and sturdy plant. Stimulates the plant to produce more flowers and enhances foliage colour.	1kg	14433

Rooting Hormones					
Product	Code	Active Ingredient	Description	Pack Size	MAPP No
Chryzopon Rose	CHRY/05	0.1% w/w 4-indol-3-ylbutyric acid (IBA).	Suitable for most softwood cuttings.	350g	09092
Chryzotop Green	CHRY/06	0.25% w/w 4-indol-3-ylbutyric acid (IBA).	Suitable for a range of semi-ripe cuttings.	350g	09085
Chryzoplus Grey	CHRY/04	0.8% w/w 4-indol-3-ylbutyric acid (IBA).	Suitable for a range of hardwood cuttings.	350g	09094



Tank Cleaners, Anti Foaming Agents and pH Adjusters			
Product	Code	Description	Pack Size
All Clear Extra	ALLC	A specially formulated spray tank cleaner and decontaminant designed for cleaning spray tanks.	5lt
SpOtless	SPOT	SpOtless is a highly formulated cleaning agent for the cleaning and decontamination of spraying equipment. It is especially effective at clearing sticky formulations.	5lt
Abate	Abate	Superior anti-foaming agent for use with all pesticides to prevent the formation of foam in the spray tank.	1lt
pHixer	PHIXER	Advanced water conditioner that can solve pH and water hardness issues. The built in indicator allows precise and accurate application and ensures optimum pH for spraying.	5lt

Disinfectants & Cleaners

Disinfectants					
Product	Code	Active Ingredient	Description	Pack Size	MAPP No
Biokill	BIOKILL/01	Peroxyacetic Acid	A colourless, stabilised liquid blend of peracetic acid and hydrogen peroxide for the effective disinfection of horticultural surfaces. Biokill has been formulated for increased surface activity.	5lt	-
Hortisept Pro	HORTI/02		Hortisept Pro Concentrate, horticultural disinfectant, Acid Free, pots, trays, greenhouse. Mixed at a ratio of 25:1 will make 130Ltr's of active solution, enough to cover approx 1300m sq. Simply spray on and leave.	5lt	-
Jet 5	JET/01 JET/02	Peroxyacetic Acid	A powerful disinfectant recognised as a food grade sanitiser with organic status, containing peroxyacetic acid, for use in all areas of horticulture and agriculture for the disinfection of all surfaces. Organic approved.	5lt 20lt	95366
Menno Florades	MENNO	Benzoic Acid	MENNO Florades is the first approved plant protection disinfectant. Menno Florades is safe to beneficial insects and mites when used as directed.	10lt	13985

Cleaners				
Product	Code	Product Type	Description	Pack Size
GS4	GS4-01	Glass cleaner	GS4 is a glass cleaner suitable for glass greenhouses. It contains no hydrogen fluoride gas and has virtually no vapour effect, therefore safer for humans and the environment.	25lt
Verritex	VERRI	Glass cleaner	A glass cleaner ideal for cleaning your glass. Ensure your greenhouse glass is crystal clear and ensure your plants grow to their full potential.	5lt
Polytex	POLYTEX/02 POLYTEX/01	Plastics cleaner	A unique cleaning and decontaminating fluid. Polytex pro is an acid and bifluoride free solution which gently removes green slime, soot, traffic film, grease, pesticide and chemical residues from upvc, polytunnels, plastic, conservatories and painted surfaces.	1lt 5lt
MMC-Pro	MMCP	Hard surface cleaner	MMC pro is an efficient way to treat mould and algae on hard surfaces. Cost effective when applied to small areas.	5lt
610 Pro	ALGA	Hard surface cleaner	610 pro is a powerful, fast acting and highly concentrated solution for the removal of algae growths on hard surfaces. Will also treat lichen, liverwort, slimes, mould and fungi. Cost effective when used on large areas.	5lt



Shading Paint

Shading Paint

Redusol

Redusol is a shading agent that reflects high levels of solar energy. It is wear-resistant and can be easily removed with ReduClean. Redusol offers up to 80% shading and can be used on glass, acrylic, polycarbonate and plastic film.

Application

Redusol is a versatile shading agent that can be used in many different situations. Depending on the climate, both light-preferring and shade-preferring crops can benefit from a coating of Redusol.

How to apply

For the best results, Redusol should be diluted with a certain amount of clean water (depending on the application method) and sprayed evenly on a dry and clean greenhouse roof.



Code	Application rate	Pack Size
PAINT/23	10-40 Drums per Ha	20kg

ReduFuse IR

ReduFuse is a coating that diffuses the light when it enters the greenhouse. Diffused light penetrates deeper into the crop and can improve production and quality.

ReduFuse is suitable for all crops that need large amounts of light.

Shading is minimal so there is no protection against heat radiation. ReduFuse has proven successful when applied to vegetable crops and highly light-dependent flowers and plants.



Code	Pack Size	Application Rate
REDU/02	20lt	18-22 Drums per Ha

Coolglass

A white shading material for glasshouses, factories etc which is easy to use – just add water. Coolglass is easy to mix and apply with a course spray. Stays on all summer.



Code	Pack Size	Pack Coverage
PAINT/20	5lt	5000m2

ReduClean

ReduClean is a special cleaning solution, designed to remove all ReduSystems coatings. It is simple to use on all greenhouse materials, including glass, acrylic, polycarbonate and plastic film. After applying the product, rainwater is usually enough for a clean result. ReduClean is economical and safe to use.



Code	Pack Size	Application Rate
REDU/03	20lt	250lt/ha

Rat & Mouse Bait

Sapphire Grain 25 Rat & Mouse Killer

Sapphire Grain 25 contains the single feed active ingredient Brodifacoum on oat grain which can control mice and rats in 1 feed.

Sapphire Grain is packed into 25g sachets to keep the bait as fresh as possible. The bait is produced using the freshest and highest quality ingredients to ensure rodents are lured to the baits quickly and infestations controlled fast. The strength of Sapphire Grain 25 offers the user a great solution to control large infestations of rodents when other baits might not work.

HOW TO USE:

1. Check for signs of activity in and around buildings. This can be burrows or runs. Rats are very cautious and will run beside buildings and look to hide in any cover that might offer them a form of safety.
2. Place tamperproof bait stations every 5-10m apart where there are signs of rodent activity and in areas where rodents would feel safe and not exposed.
3. Place 2 x 25g of Sapphire Grain into each of the bait stations.
4. Check the bait 5-7 days after the first treatment and replenish any bait taken.
5. Search for, remove and dispose of any dead rodents that are found.



Code	Active	Unit Of Sale
BAIT/01	0.0025% Brodifacoum	10 x 150g

Sapphire Paste 25 Rat & Mouse Killer

Sapphire Paste is a highly attractive bait packed with peanut oils and cereals making it very palatable to rodents ensuring infestations are controlled fast. The strength of Sapphire Paste 25 offers the user a great solution to control large infestations of rats quickly when other baits might not work.

Each 150g pouch contains paste sachets, enough for 2-3 x rat bait points.

Medium to high infestations require a number of bait points. Bait refills may be required to replenish any bait taken. Once bait-take has stopped, the infestation has been controlled, so bait must be withdrawn from the bait stations and disposed of correctly. Always read the label.

Sapphire Paste must be used with a secured tamperproof bait station.

HOW TO USE:

1. Check for signs of activity in and around buildings. This can be burrows or runs. Rats are very cautious and will run beside buildings and look to hide in any cover that might offer them a form of safety.
2. Place tamperproof bait stations every 5-10m apart where there are signs of rodent activity and in areas where rodents would feel safe and not exposed.
3. Place 60g of Sapphire paste into each of the bait stations.
4. Check the bait 5-7 days after the first treatment and replenish any bait taken.
5. Search for, remove and dispose of any dead rodents that are found.



Code	Active	Unit Of Sale
BAIT/02	0.0025% Brodifacoum	10 x 150g

Rodent Traps

Wooden Mouse Trap		
Traditional wooden mouse trap. Easy to set with a high catch rate.		
Code	Outer Qty	Unit Of Sale
TRAP/06	24 x 2 Pack	2 Pack



Scissor Mole Trap		
Easy to set, double entry scissor ole trap that kills quickly.		
Code	Outer Qty	Unit Of Sale
TRAP/01	12	Each



Wooden Rat Trap		
Traditional wooden rat trap. Easy to set with a high catch rate.		
Code	Outer Qty	Unit Of Sale
TRAP/14	12	Each



Tunnel Mole Trap		
A fast action, humane kill double entry dual setting trap. Easy set up.		
Code	Outer Qty	Unit Of Sale
TRAP/01B	24	Each



Rat Bait Station + Key		
Robust and fully secured bait station suitable for all environments.		
Code	Outer Qty	Unit Of Sale
BAIT/05	6	Each



Claw Mole Trap		
Claw type mole trap with horizontal trigger plate. Offers humane fast kill. Easy set up.		
Code	Outer Qty	Unit Of Sale
TRAP/01C	6	Each



Seeka Biological Control

Vine Weevil Seeka® CT

Vine Weevil Seeka CT contains the beneficial nematode *Steinernema kraussei* and provides effective control of black vine weevil larvae (*Otiorhynchus sulcatus*). Vine Weevil Seeka CT is formulated to provide effective control in cold to warm temperatures which range from 5°C – 30°C

BENEFITS

- Gives high levels of control between 5°C – 30°C.
- Vine Weevil Seeka can be used in organic systems or as part of an IPM programme
- Safe to users and the environment
- Nematodes survive up to approximately 4 weeks in the soil
- No pest resistance problems
- Simply applied as a drench or through irrigation systems
- Protects root system preventing subsequent damage and plant loss
- Larvae treated with Vine Weevil Seeka will not develop into adult vine weevils, eliminating unsightly damage to the foliage (typical leaf notching)



Code	Pack Coverage	Unit Of Sale
VINE-SEEKA/01	100m2	50 million
VINE-SEEKA/02	500m2	250 million

Vine Weevil Seeka®

Vine Weevil Seeka, powered by BASF technology, is based on the beneficial nematode *Heterorhabditis bacteriophora* (82%) and an inert carrier with water (18%). It provides control of black vine weevil larvae (*Otiorhynchus sulcatus*) present in soil or container-grown crops.

BENEFITS

- Fast and effective natural control
- The most robust and efficacious nematode product available for vine weevil larvae
- Control achieved at all times when the pest larvae are active
- No pest resistance problems
- Gives high levels of control between 12°C – 30°C.



Code	Pack Coverage	Unit Of Sale
VINE-SEEKA/02	100m2	50 million
VINE-SEEKA/02	500m2	250 million

Fungus Gnat Seeka®

Fungus Gnat Seeka, powered by BASF technology, is based on the beneficial nematode *Steinernema Feltiae*. It provides control of Fungus Gnat Larvae (*Sciaridae* spp. or more commonly known as Sciarid Fly) as well as Western Flower Thrips.

BENEFITS

- Fast and effective natural control
- The most robust and efficacious nematode product available for fungus gnat control
- Control achieved at all times when the pest larvae are active
- No pest resistance problems
- Gives high levels of control between 10°C – 30°C.



Code	Pack Coverage	Unit Of Sale
VINE-SEEKA/01	100m ²	50 million
VINE-SEEKA/02	500m ²	250 million

Transporter

ICL's revolutionary penetrant formulation which aids nematode dispersion within the growing media following application. Transporter is a blend of soil surfactants which optimise the distribution of water allowing for a more even spread of your nematode application, putting the nematodes where they are needed and therefore reducing waste.

BENEFITS

- Rigorously tested and no negative effects on nematode species
- Increases efficiency of each nematode application with less wastage
- Can be used in conjunction with fertilisers
- Works quickly with all substrates
- Nematodes are effectively distributed through the substrate
- Excellent spreading and penetration characteristics
- High strength product, contains 88% surfactant



Code	Application Rate	Unit Of Sale
TRANSPORTER/01	1lt/Ha	1lt

Biological Control

Biological Control System

BIOLOGICAL PEST SOLUTIONS		
Whitefly		
EN-STRIP ½ 10 strip (1500)	UK2000	Encarsia formosa pupae
EN-STRIP ½ 50 strip (7500)	02010	Encarsia formosa pupae
EN-STRIP 10 strip (3000)	02020	Encarsia formosa pupae
EN-STRIP 50 strip (15000)	02030	Encarsia formosa pupae
ENERMIX 10 strip (3000)	02360	Encarsia / Eretmocerous pupae
ENERMIX 50 strip (15000)	02370	Encarsia / Eretmocerous pupae
ERCAL 10 strip (3000)	04330	Eretmocerus eremicus pupae
ERCAL 50 strip (15000)	04340	Eretmocerus eremicus pupae
DELPHIBUG /1000	04320	1000 Delphastus catalinae per 250ml bottle
MIRICAL (500)	04380	Macrolophus pygmaeus adults
Red Spider Mite		
MIRICAL NYMPH (500)	04381	Macrolophus pygmaeus nymphs
SPIDEND (250)	03350	250 Feltiella acarisuga pupae
SPIDEX 2000	03180	Phytoseiulus persimilis
SPIDEX 10,000	03186	Phytoseiulus persimilis
SPICAL 25,000	04908	Neoseiulus californicus
SPICAL PLUS 100 sachets	04907	Neoseiulus californicus
SPICAL PLUS 500 sachets	04911	Neoseiulus californicus
SPICAL ULTIMITE 500 sachets	04903	Neoseiulus californicus
Leafminer		
MINUSA 500	02941	Dacnusa sibirica adults
MIGLYPHUS 500	02922	Diglyphus isaea adults

BIOLOGICAL PEST SOLUTIONS		
Aphids		
APHIDEND 1000	02500	Aphidoletes aphidimyza pupae
APHIDEND 10,000	02503	Aphidoletes aphidimyza pupae
APHILIN 500	04151	Aphelinus abdominalis adults
APHIPAR 500	02600	Aphidius colemani pupae
APHIPAR 1000	02602	Aphidius colemani pupae
APHIPAR 5000	02640	Aphidius colemani pupae
APHIPAR-M 1000	02682	Aphidius matricariae pupae
APHIPAR-M 5000	02680	Aphidius matricariae pupae
CHRYSOPA 1000	04280	1,000 Chrysoperla carnea per bottle
CHRYSOPA 10,000	04285	10,000 Chrysoperla carnea per bucket
APHISCOUT	02942	Aphid parasitoid mix
ERVIBANK	05270	500 grain aphids
ERVIPAR 250	02720	Aphidius ervi pupae
ERVIPAR 500	02721	Aphidius ervi pupae
ERVIPAR 5000	02740	Aphidius ervi pupae
PREDANOSTRUM pupae 100	UKBN001	Sphaerophoria rueppellii pupae - 1 WEEK LEAD TIME
PREDANOSTRUM larvae 1000	UKBN003	Sphaerophoria rueppellii larvae - 1 WEEK LEAD TIME
SYRPHIDEND 50	UK324	Episyrphus balteatus pupae - 1 WEEK LEAD TIME

Biological Control

BIOLOGICAL PEST SOLUTIONS		
Thrips		
THRIPEX 50,000	03750	Neoseiulus cucumeris
THRIPEX BUCKET 100,000	03780	Neoseiulus cucumeris
THRIPEX VERMICULITE 50,000	03970	Neoseiulus cucumeris
THRIPEX BULK 500,000	03760	Neoseiulus cucumeris
THRIPEX PLUS 500 sachets	03710	Neoseiulus cucumeris
THRIPOR-L 500	04040	Orius laevigatus
THRIPOR-L 2000	04045	Orius laevigatus
Thrips and Whitefly		
SWIRSKI MITE 50,000	05405	Amblyseius swirskii
SWIRSKI PLUS 100 schts	05410	Amblyseius swirskii
SWIRSKI PLUS 500 schts	05420	Amblyseius swirskii
SWIRSKI PLUS 500/ LD	05520	Amblyseius swirskii
SWIRSKI Ultimite 100 sachets	05431	Amblyseius swirskii
SWIRSKI Ultimite 500 sachets	05430	Amblyseius swirskii
MONTO-MITE Plus 500 sachets	05390	Transeius montdorensis
MONTO-MITE 50,000	05400	Transeius montdorensis
LIMONICA 12,500	05600	Amblydromalus limonicus
Caterpillars and Leatherjackets		
CAPSANEM 50 million	04450	Steinernema carpocapsae
CAPSANEM 500 million	04460	Steinernema carpocapsae

BIOLOGICAL PEST SOLUTIONS		
Mealybug		
Cryptolaemus adults 25	UK105	Cryptolaemus montrouzieri adults
CRYPTOBUG 500	04735	Cryptolaemus montrouzieri adults
Cryptolaemus larvae 25	UK120	Cryptolaemus montrouzieri larvae
CRYPTOBUG - L	04736	Cryptolaemus montrouzieri larvae
Leptomastix epona 25	UK261	Leptomastix epona adults ONLY SUPPLIED IN EVEN WEEKS
Leptomastix epona 100	UK260	Leptomastix epona adults ONLY SUPPLIED IN EVEN WEEKS
Mealybug mix	UK140	Various mealybug parasites
Scale Insects		
Chilocorus nigrinus 25	UK110	Chilocorus nigrinus adults
Anagyrus pseudococci 50	UK100	Anagyrus pseudococci adults
CITRIPAR 500	04770	Anagyrus pseudococci adults



Product	Pack Size	Predator
Mycotal	5lt	Mycotal is used to control white fly and thrips in vegetables, ornamentals, nursery trees and soft fruit, growing in a protected environment (country specific).
Addit	500g	Adpro Addit is an adjuvant that improves and prolongs the effect of biological, natural and chemical crop protection products and bio-stimulants.
Attracter	5lt	Attracter is a mixture of different sugars that will lure insects towards it. It does this to draw the pests out of the crops where they are sheltered and leave them in the open as an easier target.

Chemical Storage & Spraying Equipment

Chemical Storage

Safestor

The medium-duty hazardous substance cabinet that complies with all COSHH regulations.

The SafeStor is purpose built for the indoor safe storage of flammables and chemicals, including paint and other hazardous substances. Fully compliant with all legislation relating to the Control of Substances Hazardous to Health (COSHH), this robust range of cabinets features a liquid-tight sump to contain spillages, as well as galvanised shelves for maximum durability.



Code	Description	Weight	External Dimensions W x D x H (mm)	Internal Dimensions W x D x H (mm)	Sump Capacity (L)
HFC1	SafeStor	20.5kg	900 x 465 x 700	890 x 395 x 640	30
HFC2	SafeStor	12.5kg	350 x 315 x 700	335 x 245 x 640	7
HFC3	SafeStor	28kg	900 x 465 x 900	890 x 395 x 840	30
HFC4	SafeStor	31kg	450 x 465 x 905	440 x 395 x 840	17
HFC5	SafeStor	41kg	900 x 465 x 1200	890 x 395 x 1140	30
HFC6	SafeStor	68kg	1200 x 465 x 1800	1190 x 395 x 1740	45
HFC7	SafeStor	55kg	900 x 465 x 1800	890 x 395 x 1740	35

TransBank

For the safe vault storage and transportation of smaller volumes of chemicals. HSE legislation requires that anyone using chemicals must store them in a lockable container. The TransBank chemical box has been specially designed to comply with all legislation regarding the storage of chemicals, both in vehicles and in fixed locations. To maximise internal space, these vaults are built to accommodate a range of standard sized chemical containers.

- Ventilation to prevent build-up of fumes
- Over centre catch with padlock facility
- Finished in bright yellow with relevant hazard warning signs
- Built to specification for ½ hour fire resistance
- Powder coated for maximum durability
- Integral fixing points allow vaults to be secured to the floor of the vehicle
- Fully welded and tested sump base to prevent leakage
- Specially designed for chemical storage



Code	Description	Weight	External Dimensions W x D x H (mm)	Internal Dimensions W x D x H (mm)
TRB1C	Transbank	13kg	430 x 415 x 365	345 x 345 x 335
TRB2C	Transbank	20kg	530 x 485 x 540	445 x 415 x 510
TRB4C	Transbank	28kg	880 x 485 x 540	790 x 415 x 510

Chemical Storage & Spraying Equipment

Vermorel 2000Pro Comfort

Comfortable shoulder strap/back strap/waist belt set (adjustable lengthwise), weight distribution is 50% on the lower back and 50% on the shoulders.

Supplied with Nozzle Kit containing:

- 1 x Hollow Cone Nozzle 30HCX12
- 1 x Full Cone Nozzle 30FCX3
- 1 x Evenspray Nozzle 30-02E80YE
- 1 x Flood Spray Nozzle 30DT2.5
- 1 x Cup Filter 32100650



Code	Tank Size	Berthoud Reference
SPRAYER/13	16lt	102022

Electric Vermorel 3000

Berthoud's latest innovation, the new electric Vermorel 3000 sets the benchmark in the market for electric sprayers.

- Lightweight lithium ion battery for long life span
- New design for a lighter weight product
- Comfort harness for optimum comfort
- Twin diaphragm pump with viton seals
- Choice of 3 pressure settings
- Electronic pressure control for precise spray



Code	Tank Size	Berthoud Reference
SPRAYER/14	18lt	102139

Minipro

Using a compact hand pump to build up air pressure within the bottle to force the liquid out as a continuous stream as long as the trigger button is held down. Ideal for targeting hotspot areas of pests or disease.

Code	Model	Tank Size	Berthoud Reference
SPRAYER/10	CP2	1.5L	848161



Elyte 8 Hand Held Sprayer

Hand held sprayer for average and large-sized gardens: 200 to 1200m2.

Code	Tank Capacity	Berthoud Reference
SPRAYER/09	8.5lt	101001



Elyte 14 Hand Held Sprayer

Hand held sprayer for average and large-sized gardens greater than 500m2.

Code	Tank Capacity	Berthoud Reference
SPRAYER/09A	13.75lt	101004



Maxipro

A professional compression sprayer which is excellent for garden use as well as being capable of doing contractor type work.

This sprayer comes with the Cooper Pegler trigger assembly as standard; it is still the best operating valve on the market and also fits all the Cooper Pegler lance tubes and accessories.

Other popular features include:

- High resistance glass reinforced plastic (GRP) lance
- Reinforced hose for greater pressure resistance
- Carrying handle



Code	Model	Tank Capacity	Cooper Pegler Reference
SPRAYER/07	CP5	5lt	846249
SPRAYER/08	CP8	8lt	846250

Knapsack Sprayers

CP15 Evolution

The CP15 Evolution is equipped with a revolutionary new ergonomic carrying system with ultra-comfortable shoulder straps and waist belt to work better and longer. It is also fitted with two handles on the tank for easy handling.

Its unique membrane pump system ensures a long life for the equipment and maximum convenience in spraying thanks to its flexible pump.



Code	Cooper Pegler Reference	Tank Capacity
SPRAYER/03	848257	15lt



CP15 Classic

Robust and durable thanks to its unique diaphragm pump system combined with the pressure control valve: the ideal knapsack sprayer for your crop protection. The diaphragm pump system of the CP Classic creates the pressure through the deformation of a highly flexible diaphragm.



Code	Cooper Pegler Reference	Tank Capacity
SPRAYER/02	846255	15lt



CP3 Evolution

The 20 litre capacity of this knapsack sprayer CP 3 Evolution provides greater work autonomy and improved comfort thanks to its two carrying handles. Its unique diaphragm pump system ensures the longevity of the sprayer as well as an adequate and precise protection for your crops. The 20L knapsack sprayer built-in pressure relief valve guarantees precision on the type of application desired.



Code	Cooper Pegler Reference	Tank Capacity
SPRATER/05	848255	20lt



CP3 Classic

Robust and durable thanks to its unique diaphragm pump system combined with the pressure control valve: the ideal knapsack for your crop protection. The diaphragm pump system of the CP Classic creates the pressure through the deformation of a highly flexible diaphragm, the limited friction action of this diaphragm avoids premature wear to the pump due to dirty water.



Code	Cooper Pegler Reference	Tank Capacity
SPRAYER/04	846320	20lt



Chemical Storage & Spraying Equipment

CP15 2000 Series

With its unique ergonomic design and build to fulfil international standards, this agriculture-made piston series is the most comfortable, safe and capable piston pump knapsack sprayer (wide pressure range). The non-corrosive polypropylene tank, with no openings below the liquid level, substantially reduces any chance of user contamination. The sprayer is comprised of few parts and can be quickly dismantled for cleaning and maintenance without the use of tools.



Code	Cooper Pegler Reference	Tank Capacity
SPRAYER/19	846341	15lt



KS16

The KS16 is a good quality knapsack sprayer suitable for a wide range of agricultural and horticultural uses. The sprayer is designed to be robust and easy to maintain and features an internal piston pump and pressure cylinder, comfortable adjustable shoulder straps, a wide neck and filter for safety of filling operations and a 16 litre tank.

Designed for the application of all crop protection products, the sprayer is supplied with a range of nozzles suitable for most spray operations. All seals are resistant to agrochemicals.

Code	Tank Capacity
SPRAYER/01	16lt



CP3 2000 Series

With its unique ergonomic design and build to fulfil international standards, the 2000 series is the most comfortable, safe and capable piston pump knapsack sprayer (wide pressure range). The non-corrosive polypropylene tank, with no openings below the liquid level, substantially reduces any chance of user contamination. The sprayer is comprised of few parts and can be quickly dismantled for cleaning and maintenance without the use of tools.



Code	Cooper Pegler Reference	Tank Capacity
SPRAYER/20	846361	20lt



Berthoud Boostair Mist Blower

- Two-stroke single cylinder motor
- Capacity: 80 cc - Power: 5 horsepower
- Maximum rotation speed (rpm): 6,900
- Fuel: unleaded petrol + 4% oil
- Comfortable back support
- Sound level at 15m: 68 dB

Performance

- Maximum horizontal range (liquids): 15m
- Maximum air speed: 130mps
- Maximum air volume: 1,044 m3per hour

Code	Tank Capacity	Berthoud Reference
102515	16lt	102515



Chemical Storage & Spraying Equipment

Knapsack Spares

Spares	
	
Product	Reference
2 Nozzle Herbicide Boom	220516
3 Nozzle Herbicide Boom	255044
4 Nozzle Herbicide Boom	215071
'O' Ring Seal Kit	212308
Tank Lid for Vermorel 2000 Pro Comfort	212307
Berthoud Profile Trigger Assembly	280310
Pressure Valve	212315
Berthoud 1 Bar Pressure Regulator	283983
Telescopic Spray Lance 0.5 –1.2m	280362
Telescopic Spray Lance 1.2 -2.4m	280326
Telescopic Spray Lance 1.2 - 3.6m	282447
Flexible Extension Tube	211507
Spray Lance Shield	455004
Hollow Cone Nozzle Kit	200560
Herbicide Nozzle Kit	200601
Rex Variable Nozzle	210627
Nozzle Kit For All Treatments	211324
Berthoud Membrane Valves and Seals	212310
Harness for Vermorel 2000 Pro Comfort	283845

Spares	
	
Product	Reference
Classic Harness Assembly	755616
1m Lance	730411
2m Lance	730442
Telescopic Lance 1 - 2m	750702
Brass Lance 0.58m	730265
Spray Lance Shield	(741647) Plastic Lances (741648) Brass Lance
Nozzle Packs	(750286) Evenspray (750283) Anvil (750292) Hollow Cone
2 Nozzle Boom	755604
3 Nozzle Boom	755603
4 Nozzle Boom	755605
CP Lid/Filter Classic, CP15 & CP3	750401
CP Relief Valve CP Classic, CP15 & CP3	750402
CP Plastic Trigger	755826
Series 2000 (Service Pack)	750308
Service Pack Classic, CP15 & CP3	750405
Replacement Hose	(755601) 2000 Series, CP15 & CP3 (755622) CP Classic
Lower End Pack CP Classic, CP15 & CP3	750403
Crank Pack CP Classic, CP15 & CP3	750404
Piston Pack For CP 2000 Series	750432
Upper Pump CP 2000 Series	755731
CP Lid/Filter Assembly For CP 2000	750433
CP Maxi Pro (Service Pack)	(755725) Pre 2010 (283746) after 2010

Chemical Storage & Spraying Equipment

Portable Sprayers

Horticultural Sprayer 70lt

This sprayer comes complete with a 70lt tank, 30m of hose and professional spray tips. The 26amp sealed battery powers a 12v pump with a maximum 100PSI.

- 12v Pump Max. 100psi
- Full pressure control with return to tank
- 26 amp sealed battery
- Quality trickle charger
- Steel/Poly Spray Lance 60cm with storage position



Code	Tank Size	Hose Length
SPRAYER/21	70lt	30m

Horticultural Sprayer Flat Bed

Designed to be moved around on anything from a flat bed trolley to the back of a pick up. Other tank sizes are available. Please enquire.

- 12v Pump max. 100psi
- Full pressure control with return to tank
- Quality trickle charger
- In Line Filter
- Steel/Poly 60cm Spray Lance
- 30m Hose



Code	Tank Size	Hose Length
SPRAYER/23	120lt	30m

Horticultural Sprayer 25lt

- 12v Pump Max. 100psi
- Full pressure control with return to tank
- 20 amp sealed battery
- Quality trickle charger
- 6m Hose
- Steel/Poly Spray Lance 60cm
- Foot Filter
- Professional Spray Tips



Code	Tank Size	Hose Length
SPRAYER/22	25lt	6m

Trolley Sprayer 30lt

Ideal for all kinds of work around the garden or nursery. Capable of spraying at both high pressure and low pressure thanks to its simple flow adjuster, this sprayer's ease of use and workhorse like pump makes it ideal for applying disinfectants, cleaning agents and pesticides. Easy to attach to 3m and 5m telescopic lances.

- Built-in rinse mechanism
- Two Lithium Samsung 18v batteries one spare). Easy slot-in and pull-out.
- Three spray jets. High-reach, mist, and fan. Max. reach 13m
- Pressure: 4-7 Bar
- Steel lance 40cm c/w quick release fittings
- 2 hours continuous spray time with single battery
- Easy to fill and to empty.
- Recharge time: 3 hours



Code	Tank Size	Hose Length
SPRAYER/14	30lt	6m

Chemical Storage & Spraying Equipment

Portable Sprayers

Barrow Sprayer 50lt

Two wheeled barrow sprayer with powder coated steel frame complete with a 50lt polyethylene tank.

- Petrol 4 stroke and electric 230V models available
- External suction filter for easy maintenance
- 60cm lever lance with 10m hose
- 7lt fresh water tank



Code	Engine	Dimension	HP	LPM	BAR
SPRAYER-50-E	AR252 230V electric	60cm x 120cm x 62cm	1.5	25	25
SPRAYER-50-P	Four stroke Honda GP160	60cm x 120cm x 62cm	4.8	25	30

Trailed Sprayer 200lt

Barrow sprayer with powder coated frame steel frame complete with a 200lt polyethylene tank.

- Petrol 4 stroke and electric 230V models available
- External suction filter for easy maintenance
- 60cm lever lance with 10m hose (50 bar)



Code	Engine	Dimension	HP	LPM	BAR
SPRAYER-200-E	AR252 230V electric	90cm x 180cm x 100cm	1.5	25	25
SPRAYER-200-P	Four stroke Honda GP160	90cm x 180cm x 100cm	4.8	25	30

Barrow Sprayer 120lt

Two wheeled barrow sprayer with powder coated steel frame complete with a 120lt polyethylene tank with external graduated scale.

- Petrol 4 stroke and electric 230V models available
- External suction filter for easy maintenance
- 60cm lever lance with 10m hose
- 7lt fresh water tank



Code	Engine	Dimension	HP	LPM	BAR
SPRAYER-120-E	AR252 230V electric	90cm x 180cm x 100cm	1.5	25	25
SPRAYER-120-P	Four stroke Honda GP160	90cm x 180cm x 100cm	4.8	25	30

Trailed Sprayer 400lt

Barrow sprayer with powder coated frame steel frame complete with a 400lt polyethylene tank.

- Petrol 4 stroke and electric 230V models available
- External suction filter for easy maintenance
- 60cm lever lance with 10m hose (50 bar)



Code	Engine	Dimension	HP	LPM	BAR
SPRAYER-400-E	AR252 230V electric	79cm x 175cm x 120cm	1.5	25	25
SPRAYER-400-P	Four stroke Honda GP160	79cm x 175cm x 120cm	4.8	25	30

Chemical Storage & Spraying Equipment

Tyvek Disposable Coverall

Tyvek Classic Plus Type 4 B Disposable Coverall in Green. For use when using spray equipment.

Code	Size	Pack Size
COVERALL/02	Medium	Each
COVERALL/01	Large	Each
COVERALL/03	XL	Each
COVERALL/04	XXL	Each



Work Gloves

These Latex work gloves are ideal for those manual jobs.

Code	Size	Pack Size
GLOVE-ERH/01	10	Each



Chemlock 2 Piece Spray Suit

The Chemlock Type 4 2 piece spray suit is designed to offer you the greatest protection whilst spraying.

Code	Size	Pack Size
SUIT-SPRAY/01	Medium (7002)	Each
SUIT-SPRAY/02	Large (7003)	Each



Disposable Latex Gloves

These gloves offer unrivalled performance compared to similar alternatives. Powder free design reduces risk of powder contamination and keeps your hands clean.

Code	Size	Pack Size
GLOVE/03	Small	100
GLOVE/02	Medium	100
GLOVE/01	Large	100
GLOVE/04	Extra Large	100



Nitrile Spray Gloves

Use when handling pesticides.

Code	Size	Length	Pack Size
GLOVE/07	8 / M	300mm	Each
GLOVE/06	9 / L	300mm	Each
GLOVE/05	10 / XL	300mm	Each
GLOVE/13	11 / XXL	300mm	Each



Powder Free Nitrile Gloves

Ideal for those with Latex allergies who want a nitrile alternative at a great price.

Code	Size	Pack Size
GLOVE/16	Small	100
GLOVE/17	Medium	100
GLOVE/18	Large	100
GLOVE/19	Extra Large	100



Chemical Storage & Spraying Equipment

Personal Protective Equipment (PPE)

Face Shield		
Full face shield with acetate screen.		
Code	Sizes	Pack Size
SHIELD/04	1 size, adjustable	Each



Moldex Series 9000 Full Face Mask				
The most advanced full mask available. Ultra light with access due to extra large head harness opening. Easily removed with one finger using the strap release point. This product is sold without filters.				
Code	Reference	Description	Sizes	Pack Size
MASK/01-7001	9001	Mask Body c/w ABEK1 & P3 Filters	Small	Each
MASK/01-7002	9002	Mask Body c/w ABEK1 & P3 Filters	Medium	Each
MASK/01-7003	9003	Mask Body c/w ABEK1 & P3 Filters	Large	Each



Moldex 7000 Series Half Mask				
Extremely lightweight, the mask body is made from hypoallergenic material which is gentle on the skin.				
Code	Reference	Description	Sizes	Pack Size
MASK/06-7001	7001	Mask Body c/w ABEK1 & P3 Filters	Small	Each
MASK/06-7002	7002	Mask Body c/w ABEK1 & P3 Filters	Medium	Each
MASK/06-7003	7003	Mask Body c/w ABEK1 & P3 Filters	Large	Each



ABEK1 Moldex Gas Filter		
Simple snap in ABEK1 replacement gas filters for Moldex series 7000, half mask & 9000 series full mask.		
Code	Sizes	Pack Size
FILTER/01	One size	Pair

MOLDEX



P3 Particulate Filter		
Easy to Fit particulate filters - Fit direct to mask or easily onto gas filters - EN143:2001 + A1:2006 - 431355 For use with Moldex 7000 & 9000 series masks.		
Code	Sizes	Pack Size
FILTER/02	One size	Pair



Farmers Lung FFP2D Mask		
Protects against toxic dusts, mists and fumes. Automatically adjusts to different face shapes. Strong & durable.		
Code	Sizes	Pack Size
MASK/03	One size	3



Chemical Storage & Spraying Equipment

Eye Wash

Emergency eye wash.

Code	Size	Pack Size
EYE/01	500ml	Each



Arezzo Goggles

Modern, lightweight and low profile, the Arezzo goggles offer a panoramic field of vision and excellent compatibility with other forms of PPE such as the half mask respirators and safety helmets. The stylish aesthetics and its all day comfort ensures positive adoption by users.

Code	Sizes	Pack Size
GOGGLE	One size	Each



Premium BS 8599 First Aid Kit

Premium first aid kit meeting all requirements of BS 8599 –1:2011.

We offer 2 options, small kit and medium kit. Both kits feature a 27.5cm x 27cm x 9.5cm superior case with internal dividers for maximum organisation.

Code	Size	Pack Size
KIT-AID/01	Small	Each
KIT-AID/02	Medium	Each



Sievi Light Wellington Boots

This lightweight boot from Sievi is made from polyurethane to give it a longer working life than most other rubber boots. It also has great thermal insulation, keeping the foot warm even in winter weather. It features a FlexStep flexible sole with cleating to prevent slipping. The insole is removable and washable. Comes with a 12 month warranty.

Code	Sizes	Pack Size
BOOT/02-06	6	Pair
BOOT/02-07	7	Pair
BOOT/02-08	8	Pair
BOOT/02-09	9	Pair
BOOT/02-10	10	Pair
BOOT/02-11	11	Pair
BOOT/02-12	12	Pair



Moldex M5 Earmuffs

Moldex M5 Earmuffs - Conforms to EN352-1:2002 - SNR 34 - [MO-6120]

Particularly low profile, light and flexible. Easy to clean.

Code	Sizes	Pack Size
MUFF-EAR-M5	One size	Each



Irrigation

Hose Pipe

Tricoflex Hose

Exterior covering in ultra UV resistant PVC with woven polyester fibre reinforcement and two-layer smooth lining.

The multilayer design, made of an exclusive woven fibre and a double core layer, ensures that Tricoflex is highly flexible for easy handling, with excellent resistance to repeated bending, crushing and pulling as well as minor deformation under pressure.

Working temperature: -15°C to 60°C

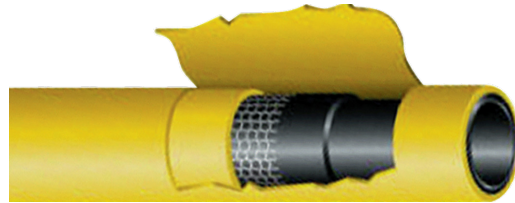

Code	Supplier Reference	Hose Diameter	Roll Length	Work Pressure
HOSE-TRIC/01	55-12-25	½"	25m	10 Bar (150 psi)
HOSE-TRIC/02	55-12-50	½"	50m	10 Bar (150 psi)
HOSE-TRIC/03	55-12-99	½"	100m	10 Bar (150 psi)
HOSE-TRIC/16	55-15-50	⅝"	50m	10 Bar (150 psi)
HOSE-TRIC/14	55-15-99	⅝"	100m	10 Bar (150 psi)
HOSE-TRIC/04	55-19-25	¾"	25m	10 Bar (150 psi)
HOSE-TRIC/05	55-19-50	¾"	50m	10 Bar (150 psi)
HOSE-TRIC/06	55-19-99	¾"	100m	10 Bar (150 psi)
HOSE-TRIC/07	55-25-25	1"	25m	8 Bar (119 psi)
HOSE-TRIC/08	55-25-50	1"	50m	8 Bar (119 psi)
HOSE-TRIC/09	55-25-99	1"	100m	8 Bar (119 psi)
HOSE-TRIC/10	55-32-25	1¼"	25m	8 Bar (119 psi)
HOSE-TRIC/11	55-32-50	1¼"	50m	8 Bar (119 psi)
HOSE-TRIC/17	55-40-25	1½"	25m	8 Bar (119 psi)
HOSE-TRIC/15	55-40-50	1½"	50m	8 Bar (119 psi)
HOSE-TRIC/18	55-50-25	2"	25m	8 Bar (119 psi)
HOSE-TRIC/19	55-50-50	2"	50m	8 Bar (119 psi)

NTS Master Plus

Thanks to the unique and original NTS PLUS double mesh, the FITT NTS MASTER PLUS hose features improved sturdiness and performance, besides a high degree of malleability, ensuring a constant flow of water without any folds or twists.

The SKY TECH technology increases resistance to cuts and abrasion and makes the hose extremely smooth and easy to manage, enabling it to slide over all surfaces and even around corners. The SKY TECH protective film, is specially designed to counter UV rays and prevents premature ageing of the hose.

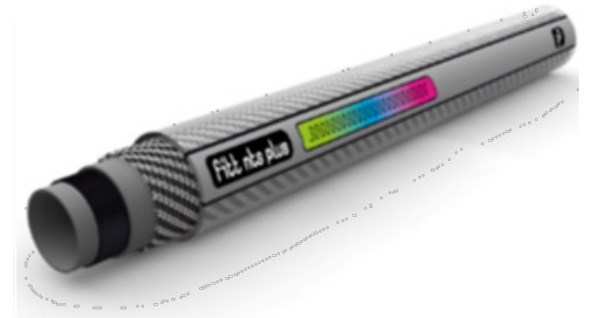

Code	Hose Diameter	Roll Length	Burst Pressure (Bar)
HOSE-MAST/01	½"	50m	50
HOSE-MAST/02	¾"	50m	33

Get in touch to receive a copy of our comprehensive irrigation catalogue

Irrigation

Hose Trolleys & Reels

Professional Hose Trolley	
Heavy duty professional hose trolley made from coated steel section, complete with quick couplings and pneumatic tyres.	
Code	Capacity
52-08-25	80m x 1" (120m x ¾ ")



Midi Trolley	
Heavy duty compact trolley specially designed for nursery pathways made from coated steel section, complete with quick couplings and pneumatic tyres.	
Code	Capacity
52-08-20	80m x ¾"



Freestanding	
Heavy duty professional free standing hose reel with quick couplings.	
Code	Capacity
52-10-25	80m x 1" (120m x ¾ ")

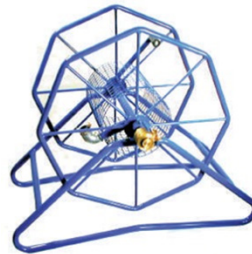

Hose Hanger	
Heavy duty steel professional hose hanger for direct fixing to inner or outer walls.	
Code	Capacity
52-10-25	80m x 1" (120m x ¾ ")



Wall Mounted Swivel	
A well engineered wall mounted tubular steel reel with swivel & locking action complete with ½" hose connectors.	
Code	Capacity
52-25-10	50m x ½"

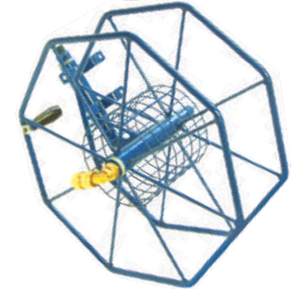

Kiros	
Modern design and state-of-the-art practicality for this compact hose reel, which can be hung from the wall with the specific brackets or transported wherever you wish, resting it stably on the ground. The Kiros assembles quickly without tools and comes complete with 20m of ½" hose and jet spray nozzle.	
Code	Capacity
REEL/01	20m x ½"



Metal Gemini			
Entirely metallic, this hose reel cart guarantees perfect drum turning, thanks to the Silent Block. Finished with epoxy resin that protects it from rust, it is complete with automatic coupling to connect the hose. It has an ideal capacity even for large-sized gardens: up to 130 metres of 1/2" hose.			
Code	Capacity	Dimensions W x H x D (mm)	Weight (kg)
TROLLEY/01	130m x ½"	643 x 865 x 461	6.54



Irrigation

Hose Pipe Quick Connectors



Hosetail	
Pushes into hose. Secure with a Jubilee clip.	
Code	Size
13-50-10	3/8"
13-50-12	1/2"
13-50-16	5/8"
13-50-19	3/4"
13-50-25	1"
13-50-32	1 1/4"
13-50-40	1 1/2"



Male	
Male thread.	
Code	Size
13-70-06	1/4"
13-70-10	3/8"
13-70-12	1/2"
13-70-19	3/4"
13-70-25	1"
13-70-32	1 1/4"
13-70-40	1 1/2"



Female	
Female thread.	
Code	Size
13-60-10	3/8"
13-60-12	1/2"
13-60-16	5/8"
13-60-19	3/4"
13-60-22	7/8"
13-60-25	1"
13-60-32	1 1/4"
13-60-40	1 1/2"



Brass Cap	
Code	
13-80-00	



Rubber Seal	
Code	
13-90-00	



Water Stop	
Code	BSP Male
10-97-00	3/4"



Y Coupling	
Code	
13-95-05	



Y With Valves	
Code	
13-95-10	

Please see our Irrigation Catalogue for all your irrigation needs

Irrigation



Brass Hose Fitting

Male BSP thread.

Code	Size
08-10-00	¼" x ¼"
08-10-01	⅜" x ⅜"
08-10-02	½" x ⅝"
08-10-11	½" x ½"
08-10-12	½" x ¾"
08-10-21	¾" x ½"
08-10-22	¾" x ¾"
08-10-23	¾" x 1"
08-10-32	1" x ¾"
08-10-33	1" x 1"
08-10-44	1¼" x 1¼"
08-10-55	1½" x 1½"
08-10-66	2" x 2"



Brass Hose Fitting

Female thread.

Code	BSP x Hose Ø
08-30-11	½" x ½"
08-30-21	¾" x ½"
08-30-22	¾" x ¾"
08-30-32	1" x ¾"
08-30-33	1" x 1"
08-30-44	1¼" x 1¼"
08-30-55	1½" x 1½"
08-30-66	2" x 2"
08-30-88	3" x 3"

2 Way Quick Connector

Code	Thread	BSP
03-90-19	Female	3/4" BSP



2 Way BSP Connector

Code	Thread	BSP
03-91-19	Female	3/4" BSP



3 Way BSP Connector

Code	Thread	BSP
03-92-19	Female	3/4" BSP



2 Way BSP Connector

Code	Thread	BSP
03-92-10	Female	3/4" BSP



Irrigation

Brass Quick Connectors & Valves

Threaded Tap Connector	
Code	BSP Female
03-10-12	½"
03-11-19	¾"
03-12-25	1"



Hose Connector with Shut Off Valve	
Code	Hose Diameter
03-35-12	½"
03-36-19	¾"



Male Adaptor	
Code	BSP Male
03-20-12	½"
03-21-19	¾"



Hose to Hose Connector	
Code	Hose Diameter
03-60-12	½"
03-61-19	¾"



Male Connector	
Code	BSP Male
03-33-19	¾"



Hose Coupler	
Bayonet Hose coupler for use with hose to bayonet connectors.	
Code	Hose Diameter
03-40-12	All



Hose to Bayonet Connector	
Code	Hose Diameter
03-30-12	½"
03-31-19	¾"



Revolving Elbow	
Code	BSP Female
03-13-19	¾"



Get in touch to receive a copy of our comprehensive irrigation catalogue

Irrigation

Hose Connector with Quick Coupler	
Code	Hose Diameter
03-86-12	½"
03-87-19	¾"



Metal Valve		
Metal valve for Geka lances.		
Code	Male BSP	Female BSP
15-21-50	¾"	¾"



Plastic Valve		
Plastic valve for Geka lances.		
Code	Male BSP	Female BSP
15-25-50	¾"	¾"



Metal Spray Gun	
Code: 03-94-76	

Metal 6 Function Spray Gun	
Code: 03-94-79	

Fertiliser Injectors

Dosatron D3GL2 Greenline				
Developed specifically for fertigation irrigation applications. The D3GL2 is also available mounted on a trolley c/w barrel for easy manoeuvrability. code DILU/05				
Code	Water Flow Rate	Dose Rate Range	Bar	Connection
DILU/04	10-3000 l/h	0.2 – 2.0%	0.3-6	3/4 Male BSP

Dosatron D9GL				
Code	Water Flow Rate	Dose Rate Range	Bar	Connection
DILU/11	500-9000 l/h	0.2 – 2.0%	0.3-8.0	1 ½" Male BSP



Dosatron D20GL2				
Code	Water Flow Rate	Dose Rate Range	Bar	Connection
DILU/20	1-20 m3/h	0.2 – 2.0%	0.12-10	2" Male BSP



Irrigation

Professional Watering Lances

Dramm ColourMark™ Professional Lances

A range of professional lances that come in 4 colours and 3 lengths. Please add choice of valve, rose and 3/4" quick coupling to complete your lance.



DRAMM

Code	Colour	Length (cm)
DRAMM-LAN16	Blue	40
DRAMM-LAN24R	Red	60
DRAMM-LAN24B	Berry	60
DRAMM-LAN24G	Green	60
DRAMM-LAN30B	Berry	75

Onetouch High Flow Valve

Durable, easy on/off fingertip control. Fitted with 3/4" BSP female thread

Code: DRAMM-VALVE/01



300 Brass Shut-Off Valve

Built to last, this valve offers unmatched durability and flow. Fitted with 3/4" BSP female thread.

Code: DRAMM-VALVE/02



1000PL Water Breaker® Nozzle

The 1000PL Redhead water breaker has over 1,000 micro holes that create an ultra-soft flower shower which will not disturb delicate soil or harm tender plants. Use with a Dramm In-Line Hose Filter to prevent clogging. Made from ABS plastic and stainless steel.

Code: DRAMM-ROSE/02



400PL Water Breaker® Nozzle

The 400PL Water Breaker provides fast, full-flow watering without damage to your plants. Patterned after the original 400 aluminium water breaker, the 400PL is made from high-impact ABS plastic and aluminium to provide a lightweight alternative. Used by professional growers worldwide.

Code: DRAMM-ROSE/01



400AL Aluminium Water Breaker® Nozzle

The original full-flow shower head nozzle. Dramm's aluminium 400 Water Breaker provides fast, full-flow watering without damage to your plants or disturbing soil. Used and recommended daily by professional growers worldwide. Cast aluminium and hand machined with 3/4 inch brass hose threads.

Code: DRAMM-ROSE/03



Fogg-it Nozzle Fine

Mist delicate seedlings, raise humidity around wilting plants. The three jets create a conical pattern at 1 gpm.

Code: DRAMM-FOGG/01



Get in touch to receive a copy of our comprehensive irrigation catalogue

Irrigation

Geka Metal "Soft Rain" Lance		
Comes complete with metal valve, quick coupling and rose giving an output of 51 litres per minute at 6 bar.		
Code	Outlet	Length
15-20-04	3/4" Male	40cm
15-20-00	3/4" Male	60cm
15-20-09	3/4" Male	90cm
15-20-12	3/4" Male	120cm



Geka Telescopic Lance		
Extendable from 1.6m to 2.8m giving an output of 51 litres per minute at 6 bar. Comes complete with valve, rose and quick coupling.		
Code	Outlet	Angle
15-65-00	3/4" Male	135°
15-60-00	3/4" Male	35°



CT Trigger Lance		
20mm aluminium amateur lance complete with trigger handle. 3/4 BSP female inlet		
Code	Outlet	Length
03100-04	3/4" Male	40
03100-06	3/4" Male	60
03100-09	3/4" Male	90
03100-12	3/4" Male	120



Small Alloy Rose Code: 15-00-05F Inlet: 3/4" Female 	Replacement Bumper Code: 15-00-19 
Large Alloy Rose Standard: 15-00-07F 1mm Coarse: 15-00-06F Inlet: 3/4" Female 	Spray Washer Nozzle Code: 15-00-40F Inlet: 3/4" Female 
Large Plastic Rose Code: 15-00-09F Inlet: 3/4" Female 	Fine Spray Nozzle Code: 15-00-48A Inlet: 3/4" Male 
"Shower" Rose Code: 15-00-15F Inlet: 3/4" Female 	Full Jet Nozzle Code: 15-00-50M Inlet: 3/4" Male 
Brass "Shower Rose" with Bumper Code: 15-00-18F Inlet: 3/4" Female 	FAN Spray Head 2mm Nozzle: 15-00-55M 3mm Nozzle: 15-00-56M Inlet: 3/4" Male 

Irrigation

LDPE & PVC Pipe

Black Polyethylene Pipe

Low Density Polyethylene Pipe (LDPE) delivers water from its source to the black 6.3mm PVC feeder pipe, which in turn delivers water to the area to be irrigated by using drippers.



Code	O.D. (mm)	I.D. (mm)	Roll Length (m)	Pressure In Bar	Type
50-16-12-1	16	13.6	100m	4	LDPE
50-20-15-1	20	17	100m	4	LDPE
50-25-20	25	21	100m	4	LDPE
50-32-20	32	28	100m	4	LDPE
50-16-12-2	16	13.6	50	4	LDPE
50-16-12	16	13.6	200	4	LDPE
50-16-12500	16	13.6	500	4	LDPE
50-20-15-2	20	17	50	4	LDPE
50-20-15-1	20	17	100	4	LDPE
50-20-15	20	17	200	4	LDPE
50-20-15500	20	17	500	4	LDPE
50-25-20	25	21	100	4	LDPE
50-25-23	25	20.4	100	6	LDPE
50-32-26	32	26.8	100	6	LDPE
50-32-26-50	32	26.8	50	6	LDPE

Black PVC Pipe

PVC feeder pipe for use with drippers within a drip irrigation system.

Code	O.D. (mm)	I.D. (mm)	Roll Length (m)	Pressure In Bar	Type
50-06-13	6.3	3.7	100	4	PVC
50-06-13-50	6.3	3.7	50	4	PVC

Drip Irrigation Pipe

Porous Pipe

Porous pipe is a rubber pipe designed for varied irrigation purposes. It should be used at a pressure of between 4-12 psi. The maximum run length is 50 metres and the output is 4 litres per hour per metre.



Code	Diameter	Roll Length
POROUS/01	16mm	100m
POROUS/02	16mm	50m

Duragarden PCND Dripline



Duragarden PCND is a pressure compensating 16mm dripline with an operating pressure range of 0.5-4 bar. The flexible tubing adapts to any design shape and is UV resistant. The self contained one piece construction assures reliability and easy installation.

Code	Outlet (l/h)	Wall	Roll Length (m)	Dripper Spacing (cm)
98APAN1121615A	1.6	1.2	25	15
98APAN1121615C	1.6	1.2	100	15
98APAN1121633A	1.6	1.2	25	33
98APAN1121633C	1.6	1.2	100	33
98APAN1121650A	1.6	1.2	25	50
98APAN1121650C	1.6	1.2	100	50

Get in touch to receive a copy of our comprehensive irrigation catalogue

Irrigation

Pipe Fittings



Barbed Connector & Reducer

Code	Size
20-00-01	16mm
20-00-02	20mm
20-00-22	25mm
20-00-33	32mm
20-10-02	20mm x 16mm
20-10-21	25mm x 20mm



Barbed Connector

Male thread.

Code	Size
20-20-02	16mm x ½"
20-20-03	16mm x ¾"
20-20-04	20mm x ½"
20-20-05	20mm x ¾"
20-20-22	25mm x ¾"
20-20-23	25mm x 1"
20-20-33	32mm x 1"



Barb / BSP Elbow

Male thread.

Code	Size
20-30-04	16mm x ½"
20-30-07	16mm x ¾"
20-30-10	20mm x ½"
20-30-12	20mm x ¾"
20-30-21	25mm x ¾"
20-30-23	25mm x 1"
20-30-34	32mm x 1"



Barbed Tee & Reducing Tee

Code	Size
20-50-01	16mm
20-50-05	20mm
20-50-22	25mm
20-50-33	32mm
20-50-12	16 x 20 x 16mm
20-50-04	20 x 16 x 20mm
20-50-20	25 x 16 x 25mm
20-50-21	25 x 20 x 25mm



Barbed Tee - Male Take Off

Male thread.

Code	Size
20-60-06	16mm x ¼"
20-60-02	16mm x ½"
20-60-03	16mm x ¾"
20-60-04	20mm x ½"
20-60-05	20mm x ¾"
20-60-21	25mm x ¾"



Barbed Connector - 2 Piece

Female thread.

Code	Size
20-41-01	16mm
20-41-02	20mm



Barbed Elbow

Female thread.

Code	Size
20-30-02	16mm
20-30-03	20mm
20-30-22	25mm
20-30-33	32mm



Barbed Plug

Code

Code	Size
20-90-02	12mm
20-90-00	16mm
20-90-01	20mm

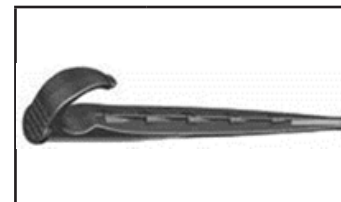

Pipe Stake

Will fit 16/20mm LDPE pipe.

Code	Size
20-97-16	



Pipe End Clamp

Code	Size
20-93-16	16mm
20-93-20	20mm

Irrigation

PVC Pipe & Fittings

PVC Pipe				
				
Code	Size	Wall	Pres. In Bar	Length
83-12-10	12mm	1mm	16	5.04m
83-16-12	16mm	1.2mm	16	5.04m
83-20-10	20mm	1.2mm	10	5.04m
83-20-15	20mm	1.5mm	16	5.04m
83-25-13	25mm	1.25mm	10	5.04m
83-32-18	32mm	1.8mm	10	5.04m
83-40-18	32mm	1.8mm	7.5	5m
83-40-20	40mm	2mm	10	5m
83-50-20	40mm	2mm	7.5	5m
83-50-24	50mm	2.4mm	10	5m
83-63-20	50mm	2mm	7.5	5m
83-63-24	63mm	2.4mm	10	5m
83-75-22	63mm	2.2mm	7.5	5m
83-75-29	75mm	2.9mm	10	5m
83-90-27	75mm	2.7mm	7.5	5m
83-90-35	90mm	3.5mm	10	5m
83110-33	90mm	3.3mm	7.5	5m
83110-42	110mm	4.2mm	10	5m
PVC Sleaving				
83-36-20	36	2mm	10	5m

Socket	
Code	Size
80-05-04	12mm
80-05-00	16mm
80-05-11	20mm
80-05-22	25mm
80-05-33	32mm
80-05-44	40mm
80-05-55	50mm
80-05-66	63mm
80-05-77	75mm
80-05-99	90mm
80-05-110	110mm
80-05-125	125mm
80-05-160	160mm

Extended Socket	
Code	Size
80-08-33	32mm
80-08-44	40mm
80-08-55	50mm
80-08-66	63mm

Reducing Socket	
Code	Size
80-11-02	12mm x 10mm
80-11-04	25/20mm x 12mm
80-11-31	40/32mm x 20mm
80-11-43	50/40mm x 32mm
80-11-53	63/50mm x 32mm
80-11-54	63/50mm x 40mm
80-11-65	63mm x 50mm
80-11-75	75mm x 50mm
80-11-76	75mm x 63mm
80-11-97	90mm x 75mm
80-11119	110mm x 90mm
80-11161	160mm x 125mm

Reducing Bush	
Code	Size
80-14-10	20mm x 16mm
80-14-20	25mm x 16mm
80-14-21	25mm x 16mm
80-14-30	32mm x 20mm
80-14-31	32mm x 20mm
80-14-32	32mm x 25mm
80-14-41	40mm x 20mm
80-14-42	40mm x 25mm
80-14-43	40mm x 32mm
80-14-52	50mm x 25mm
80-14-53	50mm x 32mm
80-14-54	50mm x 40mm
80-14-63	63mm x 32mm
80-14-64	63mm x 40mm
80-14-65	63mm 50mm
80-14-73	75mm x 32mm
80-14-74	75mm x 40mm
80-14-75	75mm x 50mm
80-14-76	75mm x 63mm
80-14-95	90mm x 50mm
80-14-96	90mm x 63mm
80-14-97	90mm x 75mm
80-14117	110mm x 75mm
80-14119	110mm x 90mm

Drilled PVC Pipe					
Code	Size	Wall	Pres.	Length	
83-32-18-M3	32	1.8	10	4.54	Drilled M11 at 1.5M
83-32-18-M5	32	1.8	10	5.04	Drilled M11 at 1.0M
83-32-18-W3	32	1.8	10	4.54	Drilled 3/8" ww at 1.5M
83-32-18-W5	32	1.8	10	5.04	Drilled 3/8" ww at 1.0M

All codes and sizes in bold type are 16 Bar rated

All others are 10 Bar rated unless otherwise stated

Get in touch to receive a copy of our comprehensive irrigation catalogue

Irrigation

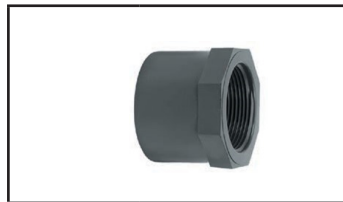

Reducing Bush	
Female thread.	
Code	Size
80-17-10	20mm x ¼"
80-17-21	25mm x ½"
80-17-31	32mm x ½"
80-17-32	32mm x ¾"
80-17-42	40mm x ¾"
80-17-43	40mm x 1"
80-17-53	50mm x 1"
80-17-54	50mm x 1¼"
80-17-64	63mm x 1¼"
80-17-65	63mm x 1½"
80-17-75	75mm x 1½"
80-17-76	75mm x 2"



Socket Adaptor	
Female thread.	
Code	Size
80-20-00	16mm x ¾"
80-20-11	20mm x ½"
80-20-21	25mm x ½"
80-20-22	25mm x ¾"
80-20-31	32mm x ½"
80-20-32	32mm x ¾"
80-20-33	32mm x 1"
80-20-43	40mm x 1"
80-20-44	40mm x 1¼"
80-20-54	50mm x 1¼"
80-20-55	50mm x 1½"
80-20-65	63mm x 1½"
80-20-66	63mm x 2"
80-20-77	75mm x 2½"
80-20-98	90mm x 3"
80-20119	110mm x 4"



Hexagon Adaptor	
Male thread.	
Code	Size
80-23-01	16mm x ½"
80-23-11	20mm x ½"
80-23-12	20mm x ¾"
80-23-21	25/32mm x ½"
80-23-21	25/32mm x ¾"
80-23-23	25/32mm x 1"
80-23-31	32/40mm x ½"
80-23-32	32/40mm x ¾"
80-23-33	32/40mm x 1"
80-23-34	32/40mm x 1¼"
80-23-43	40/50mm x 1"
80-23-44	40/50mm x 1¼"
80-23-45	40/50mm x 1½"
80-23-53	50/63mm x 1½"
80-23-54	50/63mm x 1¼"
80-23-55	50/63mm x 1½"
80-23-56	50/63mm x 2"
80-23-64	63/75mm x 1½"
80-23-65	63/75mm x 1¼"
80-23-66	63/75mm x 2"
80-23-67	63/75mm x 2½"
80-23-76	75/90mm x 2"
80-23-77	75/90mm x 2½"
80-23-78	75/90mm x 3"
80-23-98	90/100mm x 3"
80-23-99	90/110mm x 3"
80-23118	110mm x 3"
80-23119	110mm x 4"



Tee C/W Female Take Off	
Code	Size
80-39-11	20mm x ½"
80-39-22	25mm x ¾"
80-39-33	32mm x 1"
80-39-44	40mm x 1¼"
80-39-55	50mm x 1½"
80-39-66	63mm x 2"



Tee	
Equal tee.	
Code	Size
80-30-33	32mm
80-30-44	40mm
80-30-55	50mm
80-31-66	63mm
80-31-02	10mm
80-21-04	12mm
80-31-00	16mm
80-31-11	20mm
80-31-22	25mm
80-31-33	32mm
80-21-44	40mm
80-31-55	50mm
80-31-66	63mm
80-31-77	75mm
80-21-99	90mm
80-31110	110mm
80-31125	125mm
80-31160	160mm



Tee C/W Male Take Off	
75mm x 2" also available.	
Code	Size
80-35-12	20mm x ¾"
80-35-22	25mm x ¾"
80-35-23	25mm x 1"
80-35-32	32mm x ¾"
80-35-33	32mm x 1"
80-35-34	32mm x 1¼"
80-35-43	40mm x 1"
80-35-44	40mm x 1¼"
80-35-45	40mm x 1½"
80-35-53	50mm x 1"
80-35-54	50mm x 1¼"
80-35-55	50mm x 1½"
80-35-63	63mm x 1"
80-35-64	63mm x 1¼"
80-35-65	63mm x 1½"
80-35-66	63mm x 2"
80-35-74	75mm x 1¼"
80-35-76	75mm x 2"

Irrigation



Reducing Tee

Code	Size
80-33-21	25mm x 20mm
80-33-31	32mm x 20mm
80-33-32	32mm x 25mm
80-33-42	40mm x 25mm
80-33-43	40mm x 32mm
80-33-52	50mm x 25mm
80-33-53	50mm x 32mm
80-33-54	50mm x 40mm
80-33-62	63mm x 25mm
80-33-63	63mm x 32mm
80-33-64	63mm x 40mm
80-33-65	63mm x 50mm
80-33-73	75mm x 32mm
80-33-74	75mm x 40mm
80-33-75	75mm x 50mm
80-33-76	75mm x 63mm
80-33-93	90mm x 32mm
80-33-95	90mm x 50mm
80-33-97	90mm x 75mm
80-33113	110mm x 32mm
80-33115	110mm x 50mm
80-33117	110mm x 75mm
80-33119	110mm x 90mm



Male x Plain x Male Tee

Male BSP thread.

Code	Size
80-36-33	1"x 32mm
80-36-43	1 ¼"x 32mm
80-36-44	1 ¼"x 40mm



45° Elbow

Code	Size
80-51-04	12mm
80-51-00	16mm
80-51-11	20mm
80-51-22	25mm
80-51-33	32mm
80-51-44	40mm
80-51-55	50mm
80-51-66	63mm
80-51-77	75mm
80-51-99	90mm
80-51110	110mm
80-51125	125mm
80-51160	160mm



90° Elbow

Code	Size
80-41-33	32mm
80-41-44	40mm
80-41-55	50mm
80-41-66	63mm
80-42-04	12mm
80-42-00	16mm
80-42-11	20mm
80-42-22	25mm
80-42-33	32mm
80-42-44	40mm
80-42-55	50mm
80-42-66	63mm
80-42-77	75mm
80-42-99	90mm
80-42110	110mm
80-42125	125mm
80-42160	160mm



Reducing Elbow

Code	Size
80-44-43	40mm x 32mm
80-44-53	50mm x 32mm
80-44-54	50mm x 40mm



Elbow with Male Take Off

Male thread.

Code	Size
80-46-12	20mm x ¾"
80-46-23	25mm x 1"
80-46-32	32mm x ¾"
80-46-33	32mm x 1"
80-46-34	32mm x 1 ¼"
80-46-44	40mm x 1 ¼"
80-46-54	50mm x 1 ¼"



Elbow with Female Take Off

Female thread.

Code	Size
80-48-11	20mm x ½"
80-48-22	25mm x ¾"
80-48-33	32mm x 1"
80-48-44	40mm x 1 ¼"
80-48-55	50mm x 1 ½"
80-48-66	63mm x 2"

Get in touch to receive a copy of our comprehensive irrigation catalogue

Irrigation



90° Bend

Code	Size
80-54-33	32mm
80-54-44	40mm
80-54-55	50mm
80-54-66	63mm
80-54-77	75mm
80-55-22	35mm
80-55-33	32mm
80-55-44	40mm
80-55-55	50mm
80-55-66	63mm
80-55-77	75mm
80-55-99	90mm
80-55110	110mm
80-55160	160mm



S Bend

Code	Size
80-60-33	32mm
80-60-55	50mm



45° Bend

Code	Size
80-57-33	32mm
80-57-55	50mm
80-58-55	50mm
80-58-66	63mm
80-58-77	75mm
80-58-99	90mm
80-58110	110mm
80-5160	160mm



Reducing Cross

Code	Size
80-64-43	40mm x 32mm
80-64-53	50mm x 32mm



Cross

Code	Size
80-62-11	20mm
80-62-22	25mm
80-62-33	32mm
80-62-44	40mm
80-62-55	50mm
80-62-66	63mm
80-62-77	75mm
80-62-99	90mm



End Set

Code	Size
80-69-11	20 (x ½")
80-69-22	25 (x ¾")
80-69-33	32 (x 1")
80-69-34	32 (x 1 ¼")
80-69-44	40 (x 1 ½")



Cap

Code	Size
80-67-02	10mm
80-67-04	12mm
80-67-00	16mm
80-67-11	20mm
80-67-22	25mm
80-67-33	32mm
80-67-44	40mm
80-67-55	50mm
80-67-66	63mm
80-67-77	75mm
80-67-99	90mm
80-67110	110mm
80-67125	125mm
80-67160	160mm



Union

Code	Size
80-74-04	12mm
80-74-00	16mm
80-74-11	20mm
80-74-22	25mm
80-74-33	32mm
80-74-44	40mm
80-74-55	50mm
80-74-66	63mm
80-74-77	75mm
80-74-99	90mm
80-74111	110mm



7.5 Bar 3/3 Socketed Union

Code	Size
80-71-30	32mm

Irrigation

PVC Pipe & Fittings



Union - Female

Female thread.

Code	Size
80-76-11	20mm x ½"
80-76-22	25mm x ¾"
80-76-33	32mm x 1"
80-76-44	40mm x 1 ¼"
80-76-55	50mm 1 ½"
80-76-66	63mm x 2"



Union - Male

Male thread.

Code	Size
80-78-11	20mm x ½"
80-78-22	25mm x ¾"
80-78-33	32mm x 1"
80-78-44	40mm x 1 ¼"
80-78-55	50mm 1 ½"
80-78-66	63mm x 2"



Nipple

Code	Size
80-87-00	¾" x ¾"
80-87-01	¾" x ¾"
80-87-10	½" x ¾"
80-87-11	½" x ½"
80-87-21	¾" x ½"
80-87-22	¾" x ¾"
80-87-32	1" x ¾"
80-87-33	1" x 1"
80-87-43	1 ¼" x 1"
80-87-44	1 ¼" x 1 ¼"
80-87-54	1 ½" x 1 ¼"
80-87-55	1 ½" x 1 ½"
80-87-65	2" x 1 ½"
80-87-66	2" x 2"
80-87-88	3" x 3"



Cap Washer

Code	Size
80-90-11	½"
80-90-22	¾"
80-90-33	1"
80-90-44	1 ¼"
80-90-55	1 ½"
80-90-66	2"
80-90-88	3"



Pipe Clamp Without Clip

Code	Size
81-10-00	16mm
81-10-05	12mm
81-10-11	20mm
81-10-22	25mm
81-10-33	32mm



Socket - Female

Female thread.

Code	Size
80-85-00	¾" x ¾"
80-85-11	½" x ½"
80-85-13	½" x ¾"
80-85-22	¾" x ¾"
80-85-33	1" x 1"
80-85-44	1 ¼" x 1 ¼"
80-85-55	1 ½" x 1 ½"
80-85-66	2" x 2"



Screw Cap

Code	Size
80-89-00	¾"
80-89-11	½"
80-89-22	¾"
80-89-33	1"
80-89-44	1 ¼"
80-89-55	1 ½"
80-89-66	2"
80-89-77	2 ½"
80-89-88	3"



Drain Valve (Spring)

* Without elbow.

Code	Size
80-96-33	32mm
80-96-40*	1 ¼"

All codes and sizes in bold type are 16 Bar rated
All others are 10 Bar rated unless otherwise stated

Get in touch to receive a copy of our comprehensive irrigation catalogue

Irrigation



Spacing Block for Clamps

Code	Size
81-08-16	16mm
81-08-20	20mm
81-08-25	25mm
81-08-32	32mm
81-08-40	40mm
81-08-50	50mm
81-08-63	63mm
81-08-75	75mm
81-08-99	90mm



P.V.C Double Union Threaded Valve

Code	Size
25-55-12	½"
25-55-19	¾"
25-55-25	1"
25-55-32	1 ¼"
25-55-40	1 ½"
25-55-50	2"
25-55-75	3"



Saba S3

PVC adhesive.

Code	Size
81-41-03	¼lt tin with brush
80-41-05	1lt tin with brush
81-41-07	6lt tin with brush



Griffon WDF-05 Wet, Dry, Fast

PVC adhesive.

Code	Size
81-44-23	¼lt tin with brush
80-44-24	½lt tin with brush



P.V.C Single Union Threaded Valve

Code	Size
25-05-12	½"
25-05-19	¾"
25-05-25	1"
25-05-32	1 ¼"
25-05-40	1 ½"
25-05-50	2"



Saba PVC Cleaner

PVC adhesive.

Code	Size
81-42-03	¼lt tin
81-42-09	650ml tin
81-42-67	6.7kg tin



Weld-On Wet 'R' Dry 725

Wet 'R' Dry is a unique formulation containing fast evaporating solvents which provide the ability to withstand pressure tests only minutes after joints are assembled. Suitable for use on pipes sizes up to 90mm.

Code	Size
81-47-25	¼lt tin with brush
81-47-26	½lt tin with brush

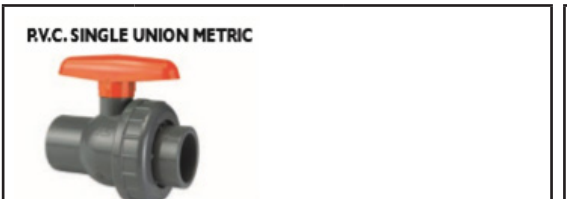

Code	Diam. mm Plain	Press in Bar
25-02-20	20	16
25-02-25	25	16
25-02-32	32	16
25-02-40	40	16
25-02-50	50	16
25-02-63	63	16



Code	Diam. mm Plain	Press in Bar
25-52-20	20	16
25-52-25	25	16
25-52-32	32	16
25-52-40	40	16
25-52-50	50	16
25-52-63	63	16
25-52-75	75	10
25-52-90	90	10
25-52110	110	10

Irrigation

Water Timers

Aquauno Video-2

Manage up to 2 irrigations a day with precision and flexibility, programming times and frequencies with only three keys and displaying all the functions on a large liquid crystal display. The programming procedure is summarised on the back of the protective cover. There is the option of selecting an irrigation time from one minute to 23 hours and 59 minutes and of excluding days of the week, if necessary. Battery-operated, therefore, no electrical connections required: simply screw it onto the tap. Its compact design allows it to be easily installed even in confined spaces.



Code	Inlet	Outlet	Bar	Programmes
TIMER/02	¾" Female	Quick-Click System	5	2 Per Day

Aquauno Logica

An automatic one-line water timer containing 15 preset cycles, selected using an exclusive control rotary knob. Simply by turning the knob to any one of the 15 numbered notches you can set the program required in a matter of seconds. All the programs available are summarized in a diagram printed on the cover. The unit is fitted with a washable stainless steel filter. One 9 V alkaline battery can power the unit for an entire season. The electronic components are perfectly sealed. With an operating pressure range of 0.5 to 10 bar, "Aquauno Logica" is 100% quality controlled and tested.



Code	Inlet	Outlet	Bar	Programmes
TIMER/01	¾" Female	Quick-Click System	5	2 Per Day

Pumps & Accessories

Foras Jet Pump

Jet type self priming pumps suggested for suction up to 7-8m deep.

Specifications:

Jet type self-priming electric pumps for suction up to 7-8 metres deep.

Motor sealed auto-ventilated.

Max. pressure: 6 bar

Water temperature: max. 40°C

These pumps are ready for installation by a qualified electrician.



Code	Pump	Power	Inlet	Outlet
PUMP/09	JET150	1.5hp	1½" F	1" F
PUMP/01	JET200	2.2hp	1½" F	1" F
PUMP/05	JET300	3.0hp	1½" F	1" F

Steel Tank Take Off

Steel tank take offs allow for suction hose to be fitted to a steel tank.



Code	Size	Unit Of Sale
73-00-20	2"(50mm)	Each
73-00-30	3"(75mm)	Each
73-00-40	4"(100mm)	Each

Suction Hose

A green medium duty spiral hose with a PVC helix reinforcement for use with suction and discharge of liquids.



Code	Diameter	Unit Of Sale
HOSE-SUC/02	1"(25mm)	1 metre
HOSE-SUC/01	2"(50mm)	1 metre

Get in touch to receive a copy of our comprehensive irrigation catalogue

Irrigation

Water Tanks

Steel Water Tanks

Our galvanised and corrugated steel water tanks are specifically designed to hold large volumes of water - from 9m³ to over 280m³. These tanks are WRAS approved.

These tanks are extremely strong and easy to install, each tank comes with a fully illustrated manual.

Each tank is flat packed onto one size pallet for easy delivery.

Spare liners and accessories available- tank covers, float valves, etc.



Diameter (ft)	Capacity (lt)
9	4,555 9,100 13,500 18,000
12	8,000 16,000 24,000 32,000
15	12,500 25,000 37,500 50,000
18	18,000 36,000 54,000 72,000
21	24,500 49,000 73,500 98,000
24	32,000 64,000 96,000 128,000
30	50,000 100,000 150,000 200,000
36	72,000 144,000 216,000 288,000
48	128,000 256,000 384,000 512,000

Plastic Water Tanks

These plastic water tanks are designed for both and commercial applications. These tanks are a one piece moulded unit which means installation is faster and costs are cheaper compared to traditional sectional steel tanks.

- Supplied as standard with pre drilled outlet
- 100% rust proof
- UK manufactured
- 10 year guarantee



Code	Capacity (lt)	Lid Size (mm)	Diameter x Height (mm)	Outlet
TANK-PLAS-500	500	455	700 x 1500	1½"
TANK-PLAS-720	720	455	700 x 2150	1½"
TANK-PLAS-1250	1250	455	1200 x 1200	1½"
TANK-PLAS-2500	2500	455	1400 x 1800	2"
TANK-PLAS-4000	4000	620	1900 x 1875	2"
TANK-PLAS-5000	5000	620	1900 x 2300	2"
TANK-PLAS-6000	6000	620	1900 x 2500	2"
TANK-PLAS-7000	7000	620	2400 x 1820	2"
TANK-PLAS-8500	8500	620	2600 x 2063	2"
TANK-PLAS-10000	10,000	620	2400 x 2500	2"
TANK-PLAS-12500	12,500	620	2600 x 2650	2"

Irrigation

Sprinklers & Stands

Coated Metal Sled Base

Made from coated steel complete with a riser and a quick coupling to connect to any geka type fitting. 68-25-15 comes with a T connection.

Code	Riser Bore	Riser Height
68-25-10	¾"	30cm
68-28-05	½"	30cm
68-25-15	¾"	30cm



Standpipes

These standpipes are made of galvanised steel. 1m high riser, in a 1" tee with two quick couplings. They come complete with a galvanised ground spike and stabilising plate.

Code	Riser Bore	Riser Height
68-20-12	½"	1m
68-20-19	¾"	1m



Cobra Sprinkler Stand

Made from heavy duty steel tube, powder coated in dark green. Coiled construction of the base means it should not tilt or tip over.

Code	Riser Bore	Riser Height
68-50-10	¾"	30cm



Freestanding

The Freestander is similar to the above but comes with a cross base allowing the standpipe to be used on hard surfaces.

Code	Riser Bore	Riser Height
68-21-12	½"	1m
68-21-19	¾"	1m



Standard Sprinkler Kit

Our standard sprinkler kit consists of, sled base, ½"riser, bush and socket, ¾" male quick coupling and PTFE tape complete with ½" Zamak Sprinkler.

Code	Riser Bore	Riser Height
68-KIT01	½"	30cm



Tripod

Galvanised steel tripod standpipe allowing for use on hard surfaces.

Code	Riser Bore
68-40-19	¾" male
68-40-25	1" male



Get in touch to receive a copy of our comprehensive irrigation catalogue

Irrigation

Hansen 16 Bar Nylon Sockets	
Code	BSP "F"
NTS05	½"
NTS07	¾"
NTS10	1"
NTS12	1¼"
NTS15	1½"
NTSR0705	¾" x ½"
NTSR1007	1" x ¾"
NTSR1210	1¼" x 1"
NTSR1510	1½" x 1"



Hansen 16 Bar Nylon Nipple	
Code	BSP "M"
NTN05	½"
NTN07	¾"
NTN10	1"
NTN12	1¼"
NTN15	1½"
NTNR0705	¾" x ½"
NTNR1005	1" x ½"
NTNR1007	1" x ¾"
NTNR1210	1¼" x 1"
NTNR1510	1½" x 1"



Hosepipe Guide	
Designed to protect floor level areas and prevent hose from becoming tangled.	
Code	
68-70-00	



Rotoframe		
Unique low pressure sprinkler featuring butterfly type rotating spinner and rotary frame which provides even water distribution.		
Code	Riser Bore	Nozzle Size
59-00-10	½"	4.5
59-00-11	¾"	4.5



Part Circle Metal Sprinkler		
Metal sprinkler with fingertip adjustment from full to part circle.		
Code	BSP Male	Nozzle Size
60-04-23-40	½"	4.0



Part Circle Metal Sprinkler		
Plastic sprinkler with fingertip adjustment from full to part circle.		
Code	BSP Male	Nozzle Size
60-04-27-28	½"	2.8
60-04-27-28	½"	4.0



Pots & Trays

Growing Trays

ECO BP JP - Young plant & nursery trays							
Code	Reference	Dimensions (cm)	No Of Cells	Cell Diameter Top (cm)	Cell Diameter Bottom (cm)	Volume (ml)	Case Qty
TRAY-ECO/01	ECO 9/15	53 x 30 x 7.1	15	8.8	6.3	294	84
TRAY-ECO/02	ECO 8/18	53 x 30 x 6.5	18	8.1	5.9	222	80
TRAY-BP/04	BP 3153/40 T	53 x 31 x 6	40	5.3	3.6	100	64
TRAY-BP/03	BP 3153/104 T	53 x 31 x 5.3	104	3.5	2.5	38	66
TRAY-BP/05	BP 3153/144 T	53 x 31 x 5.9	144	2.7	1.8	27	66
TRAY-ECO/03	ECO 6/28	50 x 28 x 6.4	28	6.2	4.7	132	128
TRAY-JP/09	JP 3050/28	50 x 28 x 5.1	28	5.7	4.6	100	142
TRAY-JP/10	JP 3050/42 P	50 x 28 x 5.4	42	5	3.5	69	204
TRAY-JP/11	JP 3050/72 P	50 x 28 x 5.4	72	4 x 3.7	2.8 x 2.5	50	145
TRAY-JP/13	JP 2553/72 T	53 x 25 x 4.2	72	3.6 x 3.4	3 x 2.8	41	90
TRAY-JP/15	JP 3050/50 T	50 x 28 x 4.8	50	4	3.3	41	180
TRAY-JP/14	JP 3050/66	50 x 28 x 4.3	66	3.9	2.8	36	186
TRAY-ECO/04	ECO 3156-9X9/18	56.5 x 31.5 x 8.8	18	8.9 x 9.3	6.3	294	68
TRAY-JP/07	JP 3050/104 T	50 x 28 x 3.8	104	2.9 x 2.9	2.4 x 2.4	21	95
TRAY-JP/05	JP 3040/54 H	37 x 28 x 7.3	54	4.7 x 3.8	3 x 2.5	74	160
TRAY-JP/01	JP 3040/54 P	37 x 28 x 5.8	54	4 x 3.6	2.8 x 2.5	59	220
TRAY-JP/07	JP 3040/80 P	37 x 28 x 4.2	160	2.8 x 2.8	2.1 x 2.1	28	220
TRAY-JP/02	JP 3040/104	37 x 28 x 4.2	230	2.5 x 2.3	1.8 x 1.6	18	220
TRAY-JP/08	JP 3050/160 T	50 x 28 x 3.9	160	2.4 x 2.3	2 x 1.9	16	85
TRAY-JP/16	JP 3050/230 H	50 x 28 x 3.5	230	1.9 x 1.7	1.5 x 1.3	7	150



Eco Tray



BP Tray



JP Tray

Pots & Trays

EP - Cultivation & Marketing Trays

Teku EP trays offer rapid growth, healthy plants and outstanding machineability.

- Reduced cultivation time
- Very low failure rates
- Easy de-nesting from the stack
- Easy to separate



Code	Reference	Dimensions (L x W x D) cm	No Of Cells	Volume (ml)	Case Qty
TRAY-EP/05	EP 2328/20-10	28 x 23 x 6.3	2 x 10 strip	125	240
TRAY-EP/02	EP 2832/20-10	32 x 28 x 6	2 x 10 strip	166	240

Teku Universal Carry Handles

Carry handles for multi cell trays with carry handle slots. Simply slot in the handle and pick up the tray.

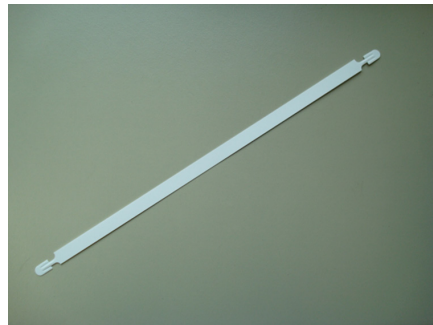

Code	Length	Colour	Pack Qty
HANDLE-TG40	40cm	White	1000
HANDLE-TG50	50cm	White	1000

Bedding Packs

AC Bedding Packs



AC Bedding plant packs are available in Black and Eco Grey.



Tray Reference	No Cell's	Length	Width	Per Shelf	Packaging Type	Pack Qty	Colour
AC4-BL/C	4	21	18	18	Case	400	Black
AC4-EG/C	4	21	18	18	Case	400	Eco Grey
AC6-BL/C	6	21	18	18	Case	400	Black
AC6-EG/C	6	21	18	18	Case	400	Eco Grey
AC6-BL/B	6	21	18	18	Pallet	5,175	Black
AC6-EG/B	6	21	18	18	Pallet	5,175	Eco Grey
AC9-BL/C	9	21	18	18	Case	400	Black
AC9-EG/C	9	21	18	18	Case	400	Eco Grey
AC12-BL/C	12	21	18	18	Case	400	Black
AC12-EG/C	12	21	18	18	Case	400	Eco Grey
CT-AC PACK	Carry Tray	53.5	42	3	Pallet	880	Black

Pots & Trays

Bedding Packs

AMC Range						
						
Code	Colour	Product	Cell Volume (ml)	Dimensions (cm)	Unit Of Sale	
TRAY-AMC/05	Black	AMC6-4	385	20.8 x 17.6	456	x
TRAY-AMC/15	PCW Grey	AMC6-4	385	20.8 x 17.6	456	✓
TRAY-AMC/06	Black	AMC6-4	385	20.8 x 17.6	3400	x
TRAY-AMC/14	PCW Grey	AMC6-4	385	20.8 x 17.6	3400	✓
TRAY-AMC/07	Black	AMC6-6	230	20.8 x 17.6	456	x
TRAY-AMC/16	PCW Grey	AMC6-6	230	20.8 x 17.6	456	✓
TRAY-AMC/07	Black	AMC6-6	230	20.8 x 17.6	3400	x
TRAY-AMC/16	PCW Grey	AMC6-6	230	20.8 x 17.6	3400	✓
TRAY-AMC/09	Black	AMC6-9	128	20.8 x 17.6	456	x
TRAY-AMC/17	PCW Grey	AMC6-9	128	20.8 x 17.6	456	✓
TRAY-AMC/10	Black	AMC6-9	128	20.8 x 17.6	3400	x
TRAY-AMC/12	PCW Grey	AMC6-9	128	20.8 x 17.6	3400	✓
TRAY-AMC/03	Black	AMC6-12	80	20.8 x 17.6	456	x
TRAY-AMC/18	PCW Grey	AMC6-12	80	20.8 x 17.6	456	✓
TRAY-AMC/04	Black	AMC6-12	80	20.8 x 17.6	3400	x
TRAY-AMC/13	PCW Grey	AMC6-12	80	20.8 x 17.6	3400	✓

AMT Carry Trays For AMC Range

				
Code	Reference	Description	Dimensions (cm)	Unit Of Sale
TRAY-AMT/02	AMT3	Carry tray - 3 packs	53.5 x 21	120
TRAY-AMT/01	AMT6	Carry tray - 6 packs	53.5 x 42	51
TRAY-AMT/03	AMT6	Carry tray - 6 packs	53.5 x 42	912

MC Bedding Plant Trays

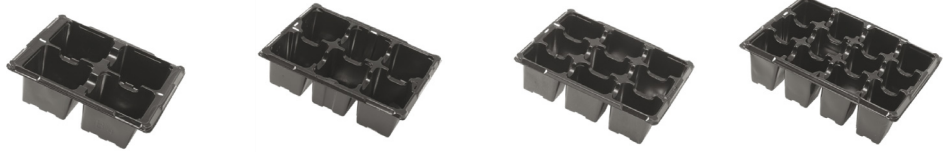
				
Code	Reference	Cell Volume (ml)	Dimensions (cm)	Unit Of Sale
TRAY-MC/02	MC4	310	23.0 x 17.5	480
TRAY-MC/03	MC6	245	23.0 x 17.5	480
TRAY-MC/04	MC6	245	23.0 x 17.5	3625
TRAY-MC/05	MC9	134	23.0 x 17.5	480
TRAY-MC/01	MC12	90	23.0 x 17.5	480

Pots & Trays

20 Cell Pack

Permanently linked pot units that fit three into our cell pack carry tray snugly, or two into a seed tray (loosely) for ease of carrying but they are self supporting so do not need the support of a seed tray.



Available as a 6, 9 & 12 cell on request.

Code	Cavity Size At Top (mm)	Depth (mm)	Case Qty
TRAY-SMITHS/02	39 x 36	60mm	400

Vacapot 15

Divides into 15 single pots.



Code	Cavity Size At Top (mm)	Depth (mm)	Case Qty
VACAPOT/02	65 x 63	60	200

Vacapot 40

Vacapot 40 fits into standard or heavyweight seed trays.
Splits into 4 strips of 10 pots.

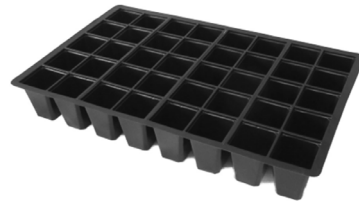

Code	Cavity Size At Top (mm)	Depth (mm)	Case Qty
VACAPOT/04	40 x 38	52mm	200

Vacapot 12

Divides into 12 single pots.

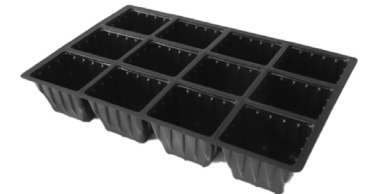

Code	Cavity Size At Top (mm)	Depth (mm)	Case Qty
VACAPOT/01	78 x 65	60	200

Vacapot 24

Designed to fit standard or heavyweight seed trays.
Splits into 24 single pots. Depth 52mm.

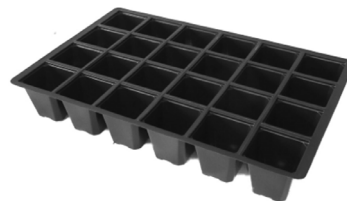

Code	Cavity Size At Top (mm)	Depth (mm)	Case Qty
VACAPOT/03	50 x 48	52	200

Vacapak 5

Divides into 5 strips. Designed for use with seed trays.





Code	Cavity Size At Top (mm)	Depth (mm)	Case Qty
VACAPAK/02	212 x 65	52	250

Pots & Trays

Seed Trays

Lightweight Seed Tray		
Standard size thermoformed seed tray for direct sowing or carry tray for Vacapot and Vacapak		
		
Code	Tray Dimensions (mm)	Case Qty
TRAY-SEED/03	344 x 214 x 52	200

Heavyweight Seed Tray		
A stronger version of the Lightweight Seed Tray.		
		
Code	Tray Dimensions (mm)	Case Qty
TRAY-SEED/02	344 x 214 x 52	150

Half Seed Trays		
Half size seed tray for direct sowing.		
		
Code	Tray Dimensions (mm)	Case Qty
TRAY-SEED/14	154 x 205 x 52	500

MST			
"Heavy duty standard seed tray available with or without drainage holes.			
			
Code	Description	Dimensions (cm)	Pack Qty
TRAY-SEED/07	Seed Tray	36.5 x 22.5	50
TRAY-SEED/08	Gravel Tray	36.5 x 22.5	50

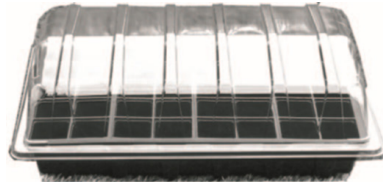
Propagator Lid - Seed Tray Size		
Clear propagator lids for seed trays, useful with or without Vacapot inserts. These lids are slightly domed in shape.		
		
Code	Tray Dimensions (mm)	Case Qty
LID-SMITH/01	344 x 214 x 52	100

Propagator Lid - Seed Tray Size		
Propagator lids for half seed trays and cell packs. These lids are slightly domed in shape.		
		
Code	Tray Dimensions (mm)	Case Qty
LID-SMITH/02	344 x 214 x 52	100

Pots & Trays

Garden Trays

Standard Garden Tray				
<p>The smallest in the range of tough injection moulded garden trays from Garland. An ideal water reservoir tray for pots and seed trays. 9 Litre internal capacity.</p> <p>Standard colour Black, Green available on request.</p>				
				
Code	Supplier Reference	External Size (L x W x D)	Capacity	Unit Of Sale
TRAY-GARDEN/05	G16B	56 x 40 x 4cm	9lt	Each

Giant Garden Tray				
<p>The Giant Tray has proved popular when used by private and commercial gardeners alike as a large irrigation table for keeping a multitude of potted plants watered. The tray can be filled with grit or capillary matting if preferred.</p> <p>Standard colour Black, Green available on request.</p>				
				
Code	Supplier Reference	External Size (L x W x D)	Capacity	Unit Of Sale
TRAY-GARDEN/07	G81B	110 x 55 x 5cm	25lt	Each

Maxi Garden Tray				
<p>A tough injection moulded garden tray. Comfortably holds 3 full size seed trays and is an ideal water reservoir tray for numerous pots. 12 Litre internal capacity.</p> <p>Standard colour Black, Green available on request.</p>				
				
Code	Supplier Reference	External Size (L x W x D)	Capacity	Unit Of Sale
TRAY-GARDEN/10	G74B	79 x 40 x 4cm	12lt	Each

Giant Plus Garden Tray				
<p>At 10cm longer than the G81B - Giant Tray, this tray has proved popular when used by private and commercial gardeners alike as a large irrigation table for keeping a multitude of potted plants watered.</p> <p>Standard colour Black, Green available on request.</p>				
				
Code	Supplier Reference	External Size (L x W x D)	Capacity	Unit Of Sale
TRAY-GARDEN/02	G82B	120 x 55 x 5cm	28lt	Each

Pots & Trays

Growbag Tray



Code	Supplier Reference	External Size (L x W x D)
TRAY-GARDEN/11	G182B	100 x 40 x 5cm

Metre Square Tray

This huge tray is one of the largest in the range with a depth of 12 cm and a massive internal capacity of 100 Litres. The Metre Square Tray features a series of shallow horizontal ridges on the internal base of the tray which aid drainage from plant pots.

Standard colour Black, Green available on request.



Code	Supplier Reference	External Size (L x W x D)	Capacity	Unit Of Sale
TRAY-GARDEN/08	G112B	100 x 100 x 12cm	100lt	Each

60cm Square Tray

The 60cm Square Tray features a series of shallow horizontal ridges on the internal base of the tray which aid drainage from plant pots.

There are many potential other applications such as a sand pit for kids, a plant irrigation display tray for garden centres and a mixing tray for cement to name but a few.

Standard colour Black, Green available on request.



Code	Supplier Reference	External Size (L x W x D)	Capacity	Unit Of Sale
TRAY-GARDEN/06	G191B	60 x 60 x 12cm	32lt	Each

1.2 Metre Square Tray

This huge tray is the largest in the range with a depth of 12cm and a massive internal capacity of 144 Litres. The tray features a series of shallow horizontal ridges on the internal base of the tray which aid drainage from plant pots.

Standard colour Black, Green available on request.



Code	Supplier Reference	External Size (L x W x D)	Capacity	Unit Of Sale
TRAY-GARDEN/09	G127B	120 x 120 x 12cm	144lt	Each

Pots & Trays

Carry Trays

Round Pot Carry Trays

A range of black carry trays for use with round 5 & 8 degree pots.

All Round Pot Carry Trays can be manufactured in Eco Grey & Taupe, minimum order runs will apply.



Code	Pot Size	Length	Width	Pots per Tray	Trays per Shelf	Per Pack	Colour
CT9/6R	9cm (Low)	28	18.4	6	14	240	Black
CT9-18R	9cm	55	31.5	18	4	25	Black
CT10.5/15	10.5cm	55	31.5	15	4	25	Black
CT13/8R	13cm	55	31.5	8	4	25	Black
CT1/8R	1lt	55	31.5	8	4	25	Black
CT1.5/6R	1.5lt	55	31.5	6	4	25	Black
CT2/6R	2lt	56.6	31.5	6	4	25	Black

Square / Round Carry Trays

A range of black carry trays for use with Square / Round pots.

All Square/Round Carry Trays can be manufactured in Eco Grey & Taupe, minimum order runs will apply.



Code	Pot Size	Length	Width	Pots per Tray	Trays per Shelf	Pack Qty	Colour
CT1/8SR(5)	1lt SQ/R	55	25.5	8	5	25	Black
CT1/10SR(5)	1lt SQ/R	55	25.5	10	5	25	Black
CT1.4/8SR(4)	1.4lt SQ/R	55	31.5	8	4	25	Black
CT1.4/8SR (5)	1.4lt SQ/R	55	25.5	8	5	25	Black
CT2/6SR (4)	2lt SQ/R	55	31.5	6	4	25	Black

Pots & Trays

Carry Trays

NX4-17/6			
Description	Dimensions (cm)	Pack Qty	Pallet Qty
6 x 17cm 5° / 2lt	56.4 x 31.5	38	1330



NX4-11/12			
Description	Dimensions (cm)	Pack Qty	Pallet Qty
12 x 11cm 8°	56.4 x 31.5	42	1470



NX4-14/6			
Description	Dimensions (cm)	Pack Qty	Pallet Qty
6 x 14cm 5° / 1.5lt	56.4 x 31.5	38	1330



NX4-10.5/15			
Description	Dimensions (cm)	Pack Qty	Pallet Qty
15 x 10.5cm 5°	56.4 x 31.5	38	1330



NX4-13/8			
Description	Dimensions (cm)	Pack Qty	Pallet Qty
8 x 13cm 5°/1lt	56.4 x 31.5	38	1330



NX4-10/15			
Description	Dimensions (cm)	Pack Qty	Pallet Qty
15 x 10cm 8°	56.4 x 31.5	38	1330



NX4-1L/2/4			
Description	Dimensions (cm)	Pack Qty	Pallet Qty
8 x 13cm 5°/8°/1lt	56.4 x 31.5	38	1330



NX4-9/15			
Description	Dimensions (cm)	Pack Qty	Pallet Qty
15 x 9cm 5°/8°	56.4 x 31.5	42	1470



NX4-13/8			
Description	Dimensions (cm)	Pack Qty	Pallet Qty
8 x 12cm 5° / 8°	56.4 x 31.5	38	1330



NX4-9/18			
Description	Dimensions (cm)	Pack Qty	Pallet Qty
18 x 9cm 8°	56.4 x 31.5	42	1470



Pots & Trays

NX4-9/20			
Description	Dimensions (cm)	Pack Qty	Pallet Qty
20 x 9cm 5°	56.4 x 31.5	42	1470



CT9/18			
Description	Dimensions (cm)	Pack Qty	Pallet Qty
18 x 9cm	54 x 31	50	1200



NX4-9F/20			
Description	Dimensions (cm)	Pack Qty	Pallet Qty
20 x 9cm 8°	56.4 x 31.5	42	1470



38138 - Square Pot Tray			
Description	Dimensions (cm)	Pack Qty	Pallet Qty
24 - 7 x 7 x 6 / 8	28 x 42	50	2,200



361116NX			
Description	Dimensions (cm)	Pack Qty	Pallet Qty
1 X 6-pack Ø 9.32 cm 2)	18 x 28	420	8,400



MT6/20			
Description	Dimensions (cm)	Pack Qty	Pallet Qty
20 x 6cm	30 x 26	180	3240



MT6/40			
Description	Dimensions (cm)	Pack Qty	Pallet Qty
40 x 6cm	53 x 31	34	935



DESCH
PLANTPAK

Pots & Trays

Shuttle Trays

ST13/8			
54.8cm x 31.4cm tray available empty or filled.			
Code	Pots	Description	Qty
TRAY-13CM/07	x	8 x 13cm 8° L	30
TRAY-13CM/08	✓	8 x 13cm 8° L	192



ST10/15			
54.8cm x 31.4cm tray available empty or filled.			
Code	Pots	Description	Qty
TRAY-10CM/02	x	15 x 110cm 8° L	30
TRAY-10CM/01	✓	15 x 110cm 8° L	264



ST11/12			
54.8cm x 31.4cm tray available empty or filled..			
Code	Pots	Description	Qty
ST11/12	x	12 x 11cm 8° L	42
TRAY-11CM/04	✓	12 x 11cm 8° L	240



ST9F/18			
54.8cm x 31.4cm tray available empty or filled..			
Code	Pots	Description	Qty
TRAY-9CM/14	x	18 x 9cm 5° H	20
ST9F/18P	✓	18 x 9cm 5° H	336



ST10.5H/15			
54.8cm x 31.4cm tray available empty or filled.			
Code	Pots	Description	Qty
TRAY-10.5CM/10	x	15 x 10.5cm 5° L	26
ST10.5H/15P	✓	15 x 10.5cm 5° L	240



ST9/18			
54.8cm x 31.4cm tray available empty or filled.			
Code	Pots	Description	Qty
TRAY-9CM/15	x	18 x 9cm 8° L	30
TRAY-9CM/17	✓	18 x 9cm 8° L	192



ST10.5/15			
54.8cm x 31.4cm tray available empty or filled.			
Code	Pots	Description	Qty
TRAY-10.5CM/01	x	15 x 10.5cm 5° L	30
ST10.5/15P	✓	15 x 10.5cm 5° L	264



Pots & Trays

Empot Handling Systems

RS.825		
Dimensions L x W x H (cm)	Pots Held	Pack Qty
420 x 420 x 46	25 x 8cm	Each
Code: EMPOT/01		



RS.8.2L		
Dimensions L x W x H (cm)	Pots Held	Pack Qty
699 x 349 x 64	8 x 2 litre	Each
Code: EMPOT/08		



RS.6.3L		
Dimensions L x W x H (cm)	Pots Held	Pack Qty
606 x 408 x 64	6 x 3 litre	Each
Code: EMPOT/07		



DT/RS918		
Dimensions L x W x H (cm)	Pots Held	Pack Qty
555 x 310 x 55	18 x 9cm	Each
Code: EMPOT/03		



RS.920		
Dimensions L x W x H (cm)	Pots Held	Pack Qty
462 x 368 x 45	20 x 9cm	Each
Code: EMPOT/06		



RS.12.1L		
Dimensions L x W x H (cm)	Pots Held	Pack Qty
568 x 428 x 50	12 x 1 litre	Each
Code: EMPOT/05		



RS.115		
Dimensions L x W x H (cm)	Pots Held	Pack Qty
565 x 340 x 60	15 x 11cm	Each
Code: EMPOT/04		



DT/RS.6.2L		
Dimensions L x W x H (cm)	Pots Held	Pack Qty
555 x 310 x 55	6 x 2lt	Each
Code: EMPOT/02		



Square Pots

VQF | V...PP | VQB - Series Pots

Standard colour black, special colours available on request.



Code	Supplier Reference	Diameter (cm)	Height (cm)	Volume (lt)	Case Qty
POT-7cm-SQ-BLK/05	VQF 7x7x6,5	7 x 7	6.5	0.18	4720
POT-7cm-SQ-BLK/06	VQF 7x7x8	7 x 7	8	0.23	4,560
POT-8cm-SQ-BLK/07	VQF 8x8x8	8 x 8	8	0.33	3,130
POT-9cm-SQ-BLK/14	VQB 9x9x8	9 x 9	8	0.44	2,350
POT-9cm-SQ-BLK/03	VQB 9x9x9,5	9 x 9	9.5	0.52	2,280
POT-9cm-SQ-BLK/16	V 9x9x10 PP	9 x 9	10	0.59	2160
POT-11cm-SQ-BLK/02	V 11x11x12 PP	11 x 11	12	1	850

Square Pots 5°



Code	Supplier Reference	Dimension (cm)	CC	Case Qty
POT-7cm-SQ-BLK/01	0707081	7 x 7 x 8	240	3528
POT-9cm-SQ-BLK/04	0909101	9 x 9 x 10	520	1232
POT-11cm-SQ-BLK/05	1111125	11 x 11 x 12	950	1240

PP Liners

These polypropylene liners have high rigidity making machine de-stacking easy. These liners have a shiny surface appearance, a high UV resistance and the 7 x 7 x 6.4 is available in 17 colours.



Code	Supplier Reference	Colour	Dimension (cm)	L		Case Qty
POT-7cm-SQ-BLK/09A	21001101	Black (01)	7 x 7 x 6.4	0.20		2160
POT-7cm-SQ-BLK/09	21021101	Black (01)	7 x 7 x 8	0.23		2160

PN Liners

The round rim on the polystyrene pots enables an easy mechanical de-stacking. The 7 X 7 X 6.4 is available in 16 colours and have a glossy surface.



Code	Supplier Reference	Colour	Dimension (cm)	L		Case Qty
POT-7.3cm-SQ-BLK/01	46574001	Black	7.3 x 7.3 x 8	0.28		2160
POT-8cm-SQ-BLK/11	46714A01	Black	8 x 8 x 7	0.30		1239
POT-9cm-SQ-BLK-03	46884001	Black	9 x 9 x 8	0.48		1104
POT-9cm-SQ-BLK/01	46904001	Black	9 x 9 x 9.5	0.59		1008

Injected Moulded Square Pots

MQD | MQC - Square Pots with tag lock

Standard colour black, special colours available on request.
 • Available in pallet quantities



TEKU®

Code	Pot Reference	Diam (cm)	Height (cm)	Lt 	Case Qty
POT-9cm-SQ-BLK/07	MQD 9x9x9,5	9 x 9	9.5	0.49	880
POT-9cm-SQ-BLK/10	MQD 9x9x10	9 x 9	10	0.51	860
POT-13cm-SQ-BLK/02	MQD 13x13x13	13 x 13	13	1.45	396
POT-11cm-SQ-BLK/03	MQC 11x11x12	11 x 11	12	1	378

MQA - Square Pots

Standard colour black, special colours available on request.
 • Also available in pallet quantities



TEKU®

Code	Pot Reference	Diam (cm)	Height (cm)	Lt 	Case Qty
POT-10cm-SQ-BLK/03	MQA 10x10x11	10 X 10	11	0.69	667
POT-15cm-SQ-BLK/01	MQA 15x15x20	15 X 15	20	3.5	130

Thermoformed Round Pots

C - Range Containers

A range of lightweight polypropylene container pots



Code	Pot Reference	Description	Colour	Diam (cm)	Height (cm)	Lt 	Case Qty
POT-1lt-RD-BLK/10	1305259	C 13cm	Black	13	11	1	736
POT-1lt-RD-BLK/09	1305259	C 13cm	Black	13	11	1	10,080
POT-1.5lt-RD-BLK/03	1505253	C 15cm	Black	15	13	1.5	516
POT-1.5lt-RD-BLK/02	1505253	C 15cm	Black	15	13	1.5	7,436
POT-2lt-RD-BLK/08	1705233	C 17cm L	Black	17	12.7	2	4,920
POT-3lt-RD-BLK/08	1905233	C 19cm L	Black	19	15.5	3	2,940
POT-4lt-RD-BLK/03	2105253	C 21cm	Black	21	16.3	4	2,625
POT-5lt-RD-BLK/16	2305253	C 23cm	Black	22.5	17	5	2,100
POT-1lt-RD-TC/03	1305259	C 13cm	D-Tect T/C	13	11	1	736
POT-1lt-RD-TC/03	1305259	C 13cm	D-Tect T/C	13	11	1	10,080
POT-1.5lt-RD-TC/02	1505253	C 15cm	D-Tect T/C	15	13	1.5	516
POT-1.5lt-RD-TC/02	1505253	C 15cm	D-Tect T/C	15	13	1.5	7,436
POT-2lt-RD-TC/04	1705233	C 17cm L	D-Tect T/C	17	12.7	2	4,920
POT-3lt-RD-TC/03	1905233	C 19cm L	D-Tect T/C	19	15.5	3	2,940
POT-4lt-RD-TC/01	2105253	C 21cm	D-Tect T/C	21	16.3	4	2,625
POT-5lt-RD-TC/02	2305253	C 23cm	D-Tect T/C	22.5	17	5	2,100

Pots & Trays

PP Thermoformed - 5°

A range of thermoformed 5° pots available in black and D-Tect Terracotta.

- Pallet quantities available



Code	Pot Reference	Description	Colour	Diam (cm)	Height (cm)	CC	Case Qty
POT-9cm-RD-BLK/04	0905258	9 cm	Black	9	7	300	2,448
POT-9cm-RD-BLK/03	0905271	9 cm H	Black	9	7.8	320	2,340
POT-10cm-RD-BLK/08	1005251	10 cm	Black	10	7.8	410	1,960
POT-10.5cm-RD-BLK/03	1055238	10,5 cm	Black	10.5	7.8	465	1,550
POT-10.5cm-RD-BLK/02	1055278	10.5/Vol 11	Black	10.5	9	525	1500
POT-12cm-RD-BLK/06	1165251	12 cm	Black	11.6	9	660	1,120
POT-13cm-RD-BLK/23	1305238	13 cm	Black	13	9,6	835	736
POT-14cm-RD/BLK/01	1405221	14 cm XL	Black	14	9	940	440
POT-9cm-RD-TC/23	0905258	9 cm	D-Tect T/C	9	7	300	2,448
POT-9cm-RD-TC/05	0905271	9 cm H	D-Tect T/C	9	7.8	320	2,340
POT-10cm-RD-TC/10	1005251	10 cm	D-Tect T/C	10	7.8	410	1,960
POT-10.5cm -RD-TC/04	1055238	10,5 cm	D-Tect T/C	10.5	7.8	465	1,550
POT-10.5cm -RD-TC/03	1055278	10.5/Vol 11	D-Tect T/C	10.5	9	525	1500
POT-12cm-RD-TC/11	1165251	12 cm	D-Tect T/C	11.6	9	660	1,120
POT-13cm-RD-TC/15	1305238	13 cm	D-Tect T/C	13	9,6	835	736
POT-14cm-RD-TC/06	1405221	14 cm XL	D-Tect T/C	14	9	940	440

PP Thermoformed - 8°

A range of thermoformed 8° pots available in black and D-Tect Terracotta.



- Pallet quantities available











Code	Pot Reference	Description	Colour	Diam (cm)	Height (cm)	CC	Case Qty
POT-9cm-RD-BLK/21	0908251	9cm	Black	9	6.7	285	2,448
POT-10cm-RD-BLK/02	1008251	10cm	Black	10	7.8	400	2,030
POT-11cm-RD-BLK/01	1108251	11cm	Black	11	8.8	520	1,440
POT-12cmRD/BLK/01	1208231	12cm	Black	12	9	620	1,140
POT-13cm-RD-BLK/24	1308238	13cm	Black	13	9.6	800	830
POT-14cm-RD-BLK/04	1408231	14cm	Black	14	10.8	1,000	840
POT-9cm-RD-TC/04	0908251	9cm	D-Tect T/C	9	6.7	285	2,448
POT-10cm-RD-TC/11	1008251	10cm	D-Tect T/C	10	7.8	400	2,030
POT-11cm-RD-TC/03	1108251	11cm	D-Tect T/C	11	8.8	520	1,440
POT-12cm-RD-TC/04	1208231	12cm	D-Tect T/C	12	9	620	1,140
POT-13cm-RD-TC/20	1308238	13cm	D-Tect T/C	13	9.6	800	830
POT-14cm-RD-TC/11	1408231	14cm	D-Tect T/C	14	10.8	1,000	840

Pots & Trays

Thermoformed Round Pots

Duo® 5° & 8° Low																			
These thermoformed pots are easily separated by machine and have a wide rim that facilitates machine handling. Their shiny surface enhances the many kerbside recyclable colours within this range.																			
<div style="display: flex; align-items: center; gap: 20px;"> <div style="text-align: center;"> <input checked="" type="checkbox"/> = Colour not kerbside recyclable </div> <div style="text-align: center;">  </div> <div style="text-align: center;">  </div> </div>																			
Ref	Dia (cm)	Height (cm)	Vol (lt)	Angle															Case Qty
					01	17	AB	A1	B1	23	EB	05	EK	15	11	12	78	54	
4412	9	6.8	0.30	5°	✓	✓	✓	✓		✓	✓	✓			✓	✓		✓	1,450
4432	10.5	8	0.48	5°	✓	✓	✓	✓		✓	✓	✓		✓	✓	✓	✓	✓	920
4445	12	9.1	0.75	5°	✓	✓	✓	✓	✓	✓	✓	✓							570
4450	13	10	0.90	5°	✓	✓						✓							456
4455	14	10.7	1	5°	✓	✓													374
4475	17	13	2	5°	✓	✓	✓	✓	✓	✓	✓	✓				✓			182
4485	19	15	3	5°	✓	✓	✓	✓	✓	✓	✓	✓				✓			144
4490	21	15.4	3.5	5°	✓	✓													92
4493	23	18	5	5°	✓	✓													60
4420	10	7.8	0.38	8°	✓	✓													1,104
4440	11	8.5	0.50	8°	✓	✓													840
4446	12	9.1	0.65	8°	✓	✓													600
4452	13	10	0.80	8°	✓	✓	✓	✓	✓	✓	✓	✓	✓	✓					456
4456	14	10.7	1	8°	✓	✓	✓	✓	✓	✓	✓	✓	✓						374



	05 White inner black.		78 Green
	11 Blue		A1 Fuchsia
	12 Orange		AB Red
	15 Silver		B1 Purple
	17 Terracotta 17, inner black		D6/EB Light Green
	23 Yellow		01 Black 01
	54 Pine Green		EK Blue

Duo 5° High

These thermoformed pots offer easy machine de-stacking and have a rigid, inverted rim that facilitates handling with forks. The stems of the plants are not damaged during transport thanks to this characteristic. Their multi-level bottom allows an optimum drainage and the large size of the holes prevents clogging.

- Available in Black & Terracotta
- Pallet quantities available on request.



Code	Colour	Vol (lt)	Dia (cm)	Height (cm)	Case Qty
443717	Terracotta	0.52	10.5	9.1	880
445317	Terracotta	1	13	11.5	432
445417	Terracotta	1.2	14	12.3	374
448017	Terracotta	2.3	17	15	182
449117	Terracotta	4	21	18	88
443701	Black	0.52	10.5	9.1	880
445301	Black	1	13	11.5	432
445401	Black	1.2	14	12.3	374
448001	Black	2.3	17	15	182
449101	Black	4	21	18	88

Implement your own ideas quickly and free of charge.

Thanks to the new Pöppelmann TEKU® 3D Studio, you can now visualise your design ideas quickly and easily in impressive quality and at the same time perform checks completely for free. Numerous design templates for various plant and pot container series from the TEKU® product range are available on www.poeppelmann.com/teku-3d. After the free download, you can edit them in popular graphics programs and then re-upload them as PDF. After a short time, you receive a freely rotatable 3D model of your individually designed plant pot or container. – Discover more in person!



Individual design ideas can be implemented quickly and easily using popular graphics programs and downloaded for free as a freely rotatable 3D Model, ready to be used in a presentation.



PÖPPELMANN

TEKU®

Thermoformed Round Pots

This is how Pöppelmann close the raw material cycle.

Plastic is a valuable raw material. Currently, only about half of the plastic from the packaging waste is recycled in Germany. We want to increase this ratio and actively contribute to closing the raw material cycle.

Plant pots in the “Recycling Blue” colour are designed in such a way that the material can be reliably identified in waste sorting. These can be used for the extraction of new Pöppelmann PCR granules, which are completely extracted from the yellow bin.

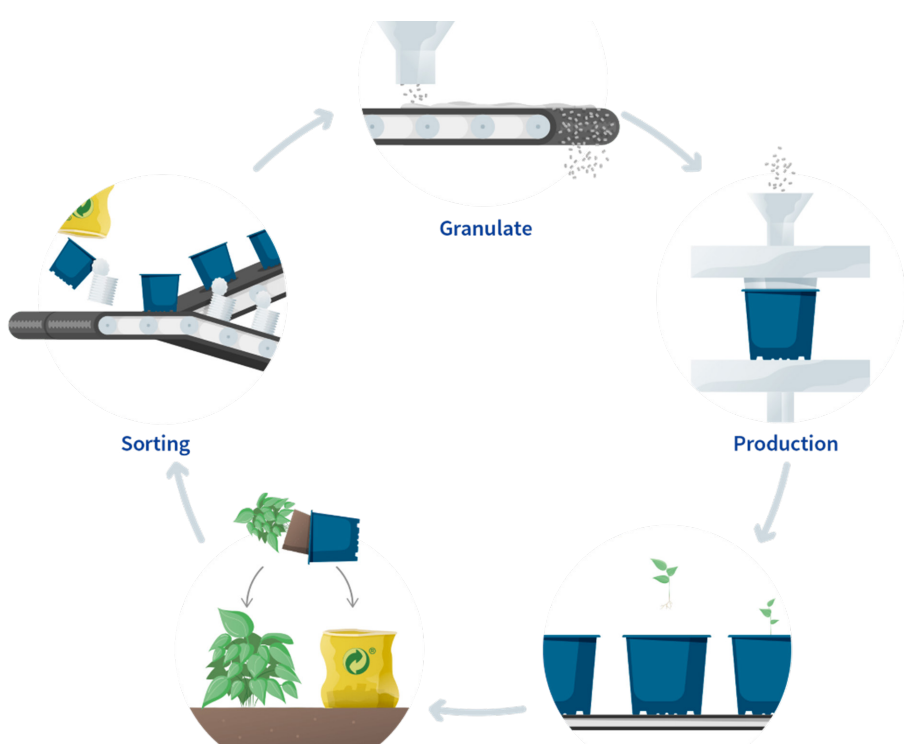

VTG - Thermoformed 8°

Available In Black and Terracotta as standard. Items in this series of 8° pots are now available on the “Recycling Blue” colour – 100% recyclable plant pots made of 100% recycled plastic

* Available in Taupe.

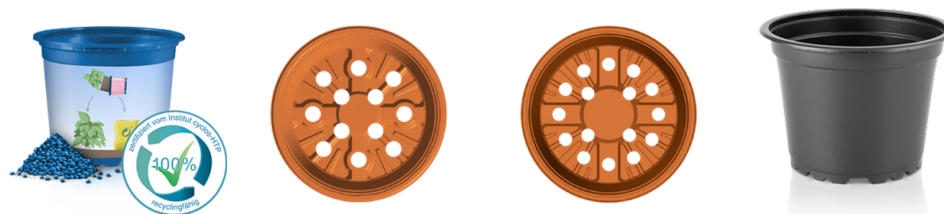

Pot Reference	Diam (cm)	Height (cm)	Volume (lt)	Case Qty
VTG 9	9	6.8	0.27	3,780
VTG 10	10	7.9	0.38	2,850
VTG 10,5	10.5	8.3	0.43	2,632
VTG 11	11	8.6	0.5	2,548
VTG 12 *	12	9.4	0.65	1,659
VTG 13 *	13	10.2	0.84	1,332
VTG 14 *	14	10.6	1	1,185

Pots & Trays

VCG - Thermoformed 5°

Available In Black and Terracotta as standard. Items in this series of 5° pots are now available on the "Recycling Blue" colour – 100% recyclable plant pots made of 100% recycled plastic.

* Available in Taupe.

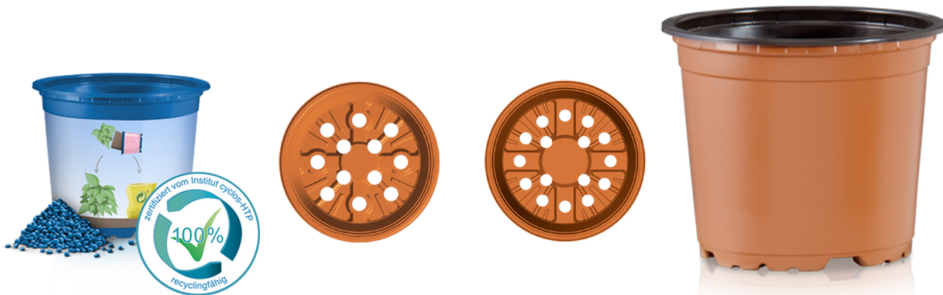

Pot Reference	Diam (cm)	Height (cm)	Volume (lt)	Case Qty
VCG 9 *	9	6.8	0.29	3,600
VCG 10	10	7.9	0.42	2,700
VCG 10,5 *	10.5	8.2	0.46	2,072
VCG 11	11	8.6	0.53	2,212
VCG 12 *	12	9.4	0.69	1,449
VCG 13 *	13	10.2	0.89	1,134
VCG 14	14	10.6	1.1	990
VCG 14 D	14	9	0.95	1,080
VCG 15	15	11.5	1.5	854
VCG 17	17	13.3	2	540
VCG 19	19	14.9	3 l	392

VCH - Thermoformed 5° Tall

Available In Black and Terracotta as standard. Items in this series of 5° tall pots are now available on the "Recycling Blue" colour – 100% recyclable plant pots made of 100% recycled plastic.

* Available in Taupe.

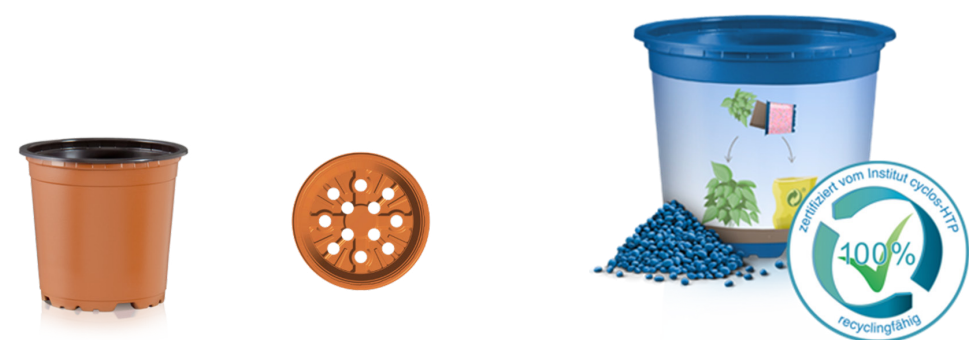

Pot Reference	Diam (cm)	Height (cm)	Volume (lt)	Case Qty
VCH 9 F *	9	9	0.37	3,132
VCH 11 VOL *	10.5	9.2	0.51	1,932
VCH 13 *	13	11.6	1	1,080

Thermoformed Round Pots

Thermo Formed Pots

These Thermoformed pots from Aeroplas are available in Terracotta, Black & Taupe.

Pot Reference	Colour	Volume (lt)	Diameter (cm)	Height (cm)	Angle	Packaging Type	Pack Qty
9cm TF-L-BL/C	Black	.285	9cm	7	5°	Case	2,625
9cm TF-L-BL/B	Black	.285	9cm	7	5°	Pallet	22,752
9cm TF-L-TC/C	T/C	.285	9cm	7	5°	Case	2,625
9cm TF-L-TC/B	T/C	.285	9cm	7	5°	Pallet	22,752
9cm TF-L-BL/C	Black	.388	9cm	9.2	5°	Case	2,450
9cm TF-L-BL/B	Black	.388	9cm	9.2	5°	Pallet	21,488
9cm TF-L-TC/C	T/C	.388	9cm	9.2	5°	Case	2,450
9cm TF-L-TC/B	T/C	.388	9cm	9.2	5°	Pallet	21,488
10.5cm TF-L-BL/C	Black	.468	10.5cm	8	5°	Case	1,728
10.5cm TF-L-BL/B	Black	.468	10.5cm	8	5°	Pallet	15,912
10.5cm TF-L-TC/C	T/C	.468	10.5cm	8	5°	Case	1,728
10.5cm TF-L-TC/B	T/C	.468	10.5cm	8	5°	Pallet	15,912
10.5cm TF-L-BL/C	Black	.518	10.5cm	9.2	5°	Case	1,800
10.5cm TF-L-BL/B	Black	.518	10.5cm	9.2	5°	Pallet	15,912
10.5cm TF-L-TC/C	T/C	.518	10.5cm	9.2	5°	Case	1,800
10.5cm TF-L-TC/B	T/C	.518	10.5cm	9.2	5°	Pallet	15,912
2LT-TF-BL/B	Black	2lt	17cm	13.1	-	Pallet	3,948
2LT-TF-BL/B	Black	3lt	19cm	14.9	-	Pallet	3,200

Square / Round Pots

Square / Round Slotted Pots

These pots are square shaped at the top and round at the base, making them more stable in transit and more efficient when using liquid feeds and plant protection products. These pots are available in Black and Taupe.

Pot Reference	Volume (lt)	Diameter (cm)	Height (cm)	Per Shelf	Packaging Type	Pack Qty
1.0LTSR-BL/N	1	11.2 x 11.2	12.5	55	Net	99
1.0LTSR-BL/B	1	11.2 x 11.2	12.5	55	Pallet	8,712
1.4LTSR-BL/N	1.4	12.5 x 12.5	13	40	Net	72
1.4LTSR-BL/B	1.4	12.5 x 12.5	13	40	Pallet	5,226
2.0LTSR-BL/N	2	14 x 14	14	36	Net	70
2.0LTSR-BL/B	2	14 x 14	14	36	Pallet	3,920
3.0LTSR-BL/N	3	15 x 15	16	24	Net	46
3.0LTSR-BL/B	3	15 x 15	16	24	Pallet	1,932
4.5LTSR-BL/N	4.5	18 x 18	19	21	Net	43
4.5LTSR-BL/B	4.5	18 x 18	19	21	Pallet	1,505
5.5LTSR-BL/N	5.5	18 x 18	24.5	21	Net	29
5.5LTSR-BL/B	5.5	18 x 18	24.5	21	Pallet	1,015

Pots & Trays

LV - Square Round Pots

These pots are square shaped at the top and round at the base, making them more stable in transit and more efficient when using liquid feeds and plant protection products. 13 colours available with Black and Terracotta being standard across the range .



Code Number	Pot Reference	Volume	External Dimensions (cm)	Case Qty
2236	0,5LVX	0.5	9 x 9 x 10	672
2208	1LVX	1	11 x 11 x 12	315
2220	2LV	2	14 x 14 x 14.5	120
2227	2LVX	2	14 x 14 x 14.5	120
2235	2,5LV	2.5	15.5 x 15.5 x 15	112
2246	3LVX	3	16 x 16 x 16.2	2688
2266	4LVX	4	17.5 x 17.5 x 18.3	1500
2275	5LV	5	18.6 x 18.6 x 20	1560

Colour availability chart

Code	01	17	AB	A1	B1	23	B5	EB	EA	05	EK	FI	54
2236	✓	✓	✓	✓	✓	✓	✓	✓	✓	✓	✓	✓	✓
2208	✓	✓	✓	✓	✓	✓	✓	✓	✓	✓	✓	✓	✓
2220	✓	✓											✓
2227			✓	✓	✓	✓	✓	✓	✓	✓	✓	✓	
2235	✓	✓											✓
2246	✓	✓											✓
2266	✓	✓											✓
2275	✓	✓											✓

	05 White		A1 Fuchsia
	B5 Plum		AB Red
	EA Orange		B1 Purple
	FI/BG Grey		EB Light Green
	17 Terracotta		01 Black 01
	23 Yellow		EK Blue
	54 Pine Green		

Pots & Trays

Rigid Containers

Round Slotted Pots

A range of round, shiny containers that come complete with a label slot. These pots are available in pallet quantities or in sleeves.

Available in **BLACK** or **TAUPE**.

• If Taupe required please state when ordering



Pot Reference	Volume (lt)	Diameter (cm)	Height (cm)	Per Shelf	Packaging Type	Pack Qty
1.0LT-SL-BL/N	1	13	114	44	Net	72
1.0LT-SL-BL/B	1	13	114	44	Pallet	6,480
1.5LT-SL-BL/N	1.5	15	130	36	Net	105
1.5LT-SL-BL/B	1.5	15	130	36	Pallet	5,880
2.0LT-SL-BL/N	2	17	135	30	Net	85
2.0LT-SL-BL/B	2	17	135	30	Pallet	3,570
3.0LT-SL-BL/N	3	19	155	21	Net	75
3.0LT-SL-BL/B	3	19	155	21	Pallet	2,625
5.0LT-SL-BL/N	5	23	176	17	Net	74
5.0LT-SL-BL/B	5	23	176	17	Pallet	1,850
7.5LT-SL-BL/N	7.5	25.4	21	11	Net	60
7.5LT-SL-BL/B	7.5	25.4	21	11	Pallet	1,200

Round Container Pots

A range of round, shiny containers. These pots are available in pallet quantities or in sleeves.

Available in **BLACK** or **TAUPE**.

• If Taupe required please state when ordering



Pot Reference	Volume (lt)	Diameter (cm)	Height (cm)	Per Shelf	Packaging Type	Pack Qty
10.0LT-R-BL/N	10	28.5	22.5	9	Net	50
10.0LT-R-BL/B	10	28.5	22.5	9	Pallet	750
12.0LT-R-BL/B	12	30	24	8	Pallet	540
15.0LT-R-BL/B	15	34	26	8	Pallet	444
20.0LT-R-BL/B	20	35.5	29	8	Pallet	306

Deep Container Pots

A range of deep, round, shiny container pots available in **BLACK** or **TAUPE**. These pots are available in pallet quantities or in sleeves.

• If Taupe required please state when ordering



Pot Reference	Volume (lt)	Diameter (cm)	Height (cm)	Per Shelf	Packaging Type	Pack Qty
2.0LT-D-BL/N	2	13.9	18.5	36	Net	70
2.0LT-D-BL/B	2	13.9	18.5	36	Pallet	4,410
3.0LT-D-BL/N	3	15.8	20.5	32	Net	56
3.0LT-D-BL/B	3	15.8	20.5	32	Pallet	2,688
4.0LT-D-BL/N	4	18.5	21	21	Net	56
4.0LT-D-BL/B	4	18.5	21	21	Pallet	1,960

Pots & Trays

SX - Containers

These eco friendly containers are manufactured by using less material while maintaining good mechanical characteristics. Fully recycled materials are used during the production of black and terracotta colours. 13 colours available within the range.

1.5L, 7.5L and 10L are only available in black and terracotta



Pot Reference	Designation	Volume	Int Ø x H (cm)	Ext Ø x H (cm)	Case Qty
6216	1,5L SX G2	1.5	14.7 x 11.9	15 x 11.9	104
6221	2L SX G2	2	16.3 x 13.2	16.7 x 13.2	114
6246	3L SX G2	3	18.6 x 14.9	19 x 14.9	102
6266	4L SX G2	4	20.5 x 16.2	20.9 x 16.2	88
6276	5L SX G2	5	22.2 x 18	22.6 x 18	84
6286	7,5L SX G2	7.5	25.2 x 20.5	25.8 x 20.5	70
6291	10L SX G2	10	27.8 x 22.6	28.4 x 22.6	64

	<i>05 White</i>		<i>A1 Fuchsia</i>
	<i>B5 Plum</i>		<i>AB Red</i>
	<i>EA Orange</i>		<i>B1 Purple</i>
	<i>FP Grey</i>		<i>EB Light Green</i>
	<i>17 Terracotta</i>		<i>01 Black 01</i>
	<i>23 Yellow</i>		<i>EK Blue</i>
	<i>CF Taupe</i>		

Rigid Containers

MCI - Containers 5°

Pronounced shoulder indents and a high degree of lateral stability ensure easy separation from the stack, couple that with the special positioning of the feet for improved conveyer belt stability and you have a pot that offers maximum efficiency.

- Easily stacked
- Better handling
- Increased loading quota per CC container
- MCI21,23 & 26 available with IML (In-Mould- Labelling)
- Standard Colour: Black (BLK), available in Terracotta (TC) also.



Code	Pot Reference	Colour	Diameter (cm)	Height (cm)	Volume (lt)	Case Qty
MCI-15-BLK	MCI 15	Black	15	11.7	1.5	400
MCI-17-BLK	MCI 17	Black	17	13.3	2	259
MCI-17K-BLK	MCI 17 K	Black	17	13.3	2	259
MCI-19Z-BLK	MCI 19 Z	Black	19	14.7	3	208
MCI-20-BLK	MCI 20	Black	20	15.6	3.5	75
MCI-21-BLK	MCI 21	Black	21	16.4	4	70
MCI-23-BLK	MCI 23	Black	23	17.9	5	65
MCI-26-BLK	MCI 26	Black	26	21.1	7.5	55
MCI-29-BLK	MCI 29	Black	29	21.8	10	55

SMH - Containers

Containers with a rigid rim for optimal automatic de-stacking and a marked shoulder for easy handling with forks. Their surface appearance is matt.



Code	Pot Reference	Volume (lt)	Colour	Ext Ø x H (cm)	Case Qty
POT-1lt-RD-BLK/04	2405	1	Black	13.2 x 10.4	110
POT-1.5lt-RD-BLK/07	2415	1.5	Black	15.1 x 11.9	116
POT-15lt-RD-BLK/02	6715	15	Black	33 x 26	15

SH Round - Deep Container

Their high and round shape is adapted to taproot plants (rose bushes, climbing plants, berry trees, etc.).

These pots are available in black with a matt finish.



Code	Pot Reference	Volume (lt)	Colour	Ext Ø x H (cm)	Case Qty
POT-1lt-RD-BLK/06	7007	1	Black	11.7 x 13.5	105
POT-2lt-RD-BLK/05	7016	2	Black	14.9 x 17.4	85
POT-3lt-RD-BLK/03	7027	3	Black	16.8 x 19.2	80
POT-4lt-RD-BLK/11	7028	4	Black	18.8 x 21.8	75
POT-5.5lt-RD-BLK/01	7031	5.5	Black	20 x 25.7	50
POT-7lt-RD-BLK/01	7035	7	Black	22.3 x 25.5	50

Pots & Trays

Roma - Deco Container

These “ready-to-display” containers can be used as cultivation containers or cover pots. This wide and complete range offers sizes from 1.1L to 25L.

- Available in 8 colours
- Original Roma pattern
- Multi level bottom



Build your product code: Use Pot reference –colour, for example, 2705-25 = 1.1lt in clay.

Pot Reference	Volume (lt)	Ext Ø x H (cm)	Covers Pot	Available Colours								Case Qty
				A1	B1	EB	CF	25	68	F1	54	
2705	1.1	14 x 11	-					✓				240
2710	1.5	16 x 12	-				✓	✓	✓	✓	✓	160
2715	2	17.5 x 13.4	-	✓	✓	✓		✓				68
2720	2.4	19 x 14	2lt				✓	✓	✓	✓	✓	76
2740	3	20 x 15.3	-	✓	✓	✓	✓	✓	✓	✓	✓	64
2745	3.5	21.4 x 16.1	3lt				✓	✓	✓	✓	✓	64
2765	4.6	23.5 x 17.8	4lt	✓	✓	✓	✓	✓	✓	✓	✓	62
2775	5.9	25.4 x 19.4	5lt	✓	✓	✓	✓	✓	✓	✓	✓	56
2785	8.7	29.2 x 22	7.5lt				✓	✓	✓	✓	✓	48
2790	11.5	32.2 x 24.2	10lt				✓	✓	✓	✓	✓	44
2795	15	34.8 x 26.5	-				✓	✓	✓	✓	✓	15
2798	25	40.9 x 31.4	-				✓	✓	✓	✓	✓	15

	54 Pine Green		EB Green
	25 Clay		F1 Grey
	A1 Fuchsia		CF Taupe
	B1 Purple		68 Stone

Plants Supports

STG Series - Plant Supports				
				
STG Reference		Top Diam (cm)	Height (cm)	Case Qty
STG 10-10,5	Ø 10-10,5 cm	13.2	11	810
STG 11	Ø 11 cm	13.2	11	810
STG 12	Ø 12, TO 12 BD & VCG 12 D	14.9	12	602
STG 13 R	Ø 13 cm + VCE 14	16.2	14.5	-
STG 13 B-R	Ø 13 cm + VCE 14	16.7	17	-
STG 14 B-R	VTG 14; VCG 14; VCG 14 D; VCH 14; VCE 14; MCH 14; VDA 14; VAA 14	17.5	18	352
STG 17	VCG 17, VCH 17, MCI 17, MCI 17 K, MDD 17, MCL 17, MCH 17	21.3	14.7	75
STG 19	VCG 19, VCH 19, MCH 19 MCL 19	23.7	16.3	75
STG 19 Z	MCI 19 Z, MCI 19 K, MDD 19	23.7	16.3	75

Sopafix Plant Supports For Round Pots

The Sopafix support system perfectly fit round pots, although manufactured to fit Soparco pots as detailed in the chart below, this does not mean to say they wont fit a different pot with the same characteristics. These supports not only offer support to the plant they also can act as a handle allowing you to pick the pot up in a quick, efficient manner.

Reference Code	Upper Ø x H (cm)	To Fit Pot	Case Qty
3901	11.7 x 11	4412, 9cm 5°	2400
3906	13.2 x 12	4432, 10.5cm Low 5° 4437, 10.5cm High 5°	1080
3911	15.5 x 13	4440, 11cm 8°	5390
3915	16.5 x 13	4445, 12cm 5° 4446, 12cm 8° Low 6622, 4lt SX G2	945
3916	14.8 x 12.9	4445, 12cm 5° 4446, 12cm 8° Low	736
3921	16.7 x 14	4450, 13cm Low 5° 4452, 13cm Low 8°	1120
3918	16.5 x 17.5	4450, 13cm Low 5° 4452, 13cm Low 8°	800
3925	18 x 18	4456, 14cm Low 8°	680
3927	17.9 x 14	4456, 14cm Low 8°	714
3938	19.8 x 12.5	6221, 2lt SX G2	552
3942	21 x 17.5	4475, 17cm Low 5° 4480, Duo 17cm High 6221, 2lt SX G2	385
3953	22 x 13.4	6246, 3lt SX G2	200
3954	22 x 13.4	4485, 19cm 5°	200
3955	23.5 x 19	6246, 3lt SX G2	150
3957	25.5 x 17	6266, 4lt SX G2	176
3960	25.5 x 17	8465, 4lt SMV G2	176
3961	25.5 x 17	4491, 21cm High 5°	176
3964	27.7 x 15.3	4493, 23cm 6276, 5lt SX G2	154

Pots & Trays



Sopafix Plant Supports For Square & Square / Round Pots

The Sopafix supports for square and square/round pots fit perfectly to pot, although manufactured to fit Soparco pots as detailed in the chart below, this does not mean to say they won't fit a different pot with the same characteristics. These supports not only offer support to the plant they also can act as a handle allowing you to pick the pot up in a quick, efficient manner.

Reference Code	Upper Ø x H (cm)	To Fit Pot	Case Qty
3902	13.4 x 12	2236, 0.5LV	6300
3904	13.4 x 12	9x9x10	330
3913	18. x 14	2208, 1L V X Square/Round 11x11x11	1620
3923	19 x 19 x19	2227, 2L V X Square/Round	350
3932	26.5 x 19	2235, 2.5 LV Square / Round	560



Luxe Pots

These "houseplant" pots are particularly suitable for orchids or epiphytic plants. The bottom of these pots avoid contact with the growing surface and thus limit the spread of bacterial contamination.

These high shape containers have a surface appearance alternating bright and sandblasted vertical strips.



Reference Code	Description	Colour	Volume (lt)	Ø EXT x H (cm)	Sopafix	Case Qty
66301017	Luxe 14 ES	Terracotta	1.2	14 x 12.3	3925	288
66351017	Luxe 15 ES	Terracotta	1.5	15 x 13.1	3931	231
66401017	Luxe 17 ES	Terracotta	2.15	17 x 14.9	3942	126
66451017	Luxe 19 ES	Terracotta	3.1	19 x 16.6	3951	96
66501017	Luxe 21 ES	Terracotta	4.2	21 x 18.4	3961	70
66551017	Luxe 24 ES	Terracotta	6.3	24 x 21	-	60
66602017	Luxe 27 ES	Terracotta	9.4	27 x 23.4	-	50

MPB Pots

6cm injection moulded pot by Teku. The MPB has a Multi-hole profile bottom which allows for faster water uptake and increased drainage resulting in shorter cultivation times.



TEKU®

Code	Supplier Reference	Colour	Diameter (cm)	Height (cm)	Volume (lt)	Case Qty
POT-6cm-RD-BLK/02	MPB 6	Black	6	5.8	0.11	4,110
POT-6cm-RD-TC/03	MPB 6	Terracotta	6	5.8	0.11	4,110

Pots & Trays

House Plant Pots

PP Injection Moulded - F and FY Range

Traditional style tall houseplant pots ranging from 6cm to 13cm. These pots come with a gloss finish and flat base drainage, except for the 9FY and 10.5FY which have 2 tier drainage. These pots are terracotta in colour.

* 3 Label slots



Code	Supplier Reference	Colour	Volume (cc)	Diameter (cm)	Height (cm)	Case Qty
6E-TC	6E	T/C	120	6	5.7	4440
9FY-TC	9FY*	T/C	356	9.25	9	966
10F-TC	10F	T/C	450	10	8.7	960
10.5FY-TC	10.5FY*	T/C	451	10.5	8.2	774
12F-TC	12F	T/C	830	12	10.7	598
13F-TC	13F	T/C	1,120	13.5	11.7	396
19F-TC	19F	T/C	2,400	18.5	16.4	125
21F-TC	21F	T/C	4,300	21	18.4	84
23F-TC	23F	T/C	6,200	23.5	20.6	45
26F-TC	26F	T/C	8,600	26	22.8	70

A1 8°High Shape (9F)

These high shape pots have a shiny surface appearance and have a 2-level draining bottom. This pot is available in Terracotta & Black.



Code	Reference	Colour	Volume (lt)	Ext Ø x H (cm)	Case Qty
POT-9cm-RD-BLK/01	6025	Black	0.44	9.3 x 9	945
POT-9cm-RD-TC/03	6025	Terracotta	0.44	9.3 x 9	945

Plant Pot Saucers

Our Ranges



Product	Colour	Size (cm)	Colour	Size (cm)
Corolle	Black	14 16 18	Terracotta	14 16 18
Lourdes	Black	25.8 29.8 39.6	Terracotta	44.4 49.4
Erica	Terracotta	14 16 18 20 22 24 28 30 33 38		
Odena	Terracotta	16 22 24 26 28 30 35		

Pots & Trays

Heavy Duty Containers

Heavy Duty Pots				
Code	Volume (lt)	Diameter (cm)	Height (cm)	Unit Of Sale
HDP-10	10	26	22	10
HDP-12	12	28	24	10
HDP-12-T	12	26	26	10
HDP-15	15	30	26	10
HDP-20	20	32	26	10
HDP-25	25	35	28	Each
HDP-35	35	40	31	Each
HDP-40	40	42	32	Each

Heavy Duty Pots				
Code	Volume (lt)	Diameter (cm)	Height (cm)	Unit Of Sale
LCWH-160	160	80	51	Each
LCWH-210	210	80	55	Each
LCWH-230	230	85	55	Each
LCWH-285	285	95	55	Each
LCWH-350	350	95	73	Each
LCWH-500	500	102	82	Each
LCWH-600	600	120	68	Each
LCWH-750	750	120	78	Each
LCWH-1000	1000	140	90	Each
LCWH-1500	1500	155	100	Each

Heavy Duty Pots With Handles				
Code	Volume (lt)	Diameter (cm)	Height (cm)	Unit Of Sale
HDPWH-30	30	40	33	Each
HDPWH-35	35	45	37	Each
HDPWH-43	43	50	34	Each
HDPWH-50	50	50	41	Each
HDPWH-60	60	55	38	Each
HDPWH-65	65	55	41	Each
HDPWH-70	70	55	44	Each
HDPWH-75	75	55	48	Each
HDPWH-80	80	60	43	Each
HDPWH-90	90	60	48	Each
HDPWH-100	100	60	51	Each
HDPWH-110	110	65	51	Each
HDPWH-125	125	65	54	Each
HDPWH-130	130	70	51	Each
HDPWH-155	155	75	51	Each
HDPWH-160	160	80	51	Each



Pots & Trays

Cover Pots



Teku Coverpots turn plain pots into eye catching designs. A large range for every occasion: Christmas, Halloween, Easter or a loved one and many more, or design your own. (Minimum orders apply)



Item		cm	cm	cm	ml	
MDF 9	VCG 9; VCH 9; MXC 9; TO 9D; MCD 9	9.5	6.8	10.5		600
MDF 11	VTG 10.5; VCG10.5; MXC 10.5; VTG11; VCG 11; VCC 11 VOL; VCH 11; VCH 11 VOL	11	7.8	12.2	[D-180	300
MDF 12	VTG 12; VCG 12D; VCG 12; VCH 13 VOL; MXC 12; MCO 12; MCP 12	12.1	8.1	13.5	110-312	300
MDF 14	VTG 14; VOG 14; VOG 14 D; VCH 14; MXC 14; MCH 14	14.2	9.9	15.8	250-530	308
MDF 17	VCG 17; VCH 17; MCL 17; MCH 17; MCI 17	17.2	12.7	19	450-730	153
MDF 19	VCG 19; VCH 19; MCI 19 Z; MCL 19; MCH 19	19.4	15.1	21.6	450-1250	78
WS+						300

Hado Pots

Layflat polythene pots, simply open up the bag and fill with compost.



Code	Reference	Gauge	Filled Size Diameter / Height	Capacity (lt)	Case Qty
HADO/01	HP1	200	3 x 3"	0.5	8000
HADO/08	HP2	250	3.5 x 4.5"	1	5000
HADO/09	HP3	250	4.5 x 5.5"	1.5	3500
HADO/15	HP4	250	5 x 6"	2	3000
HADO/05B	HP5	500	6 x 4.5"	2	1500
HADO/10	HP6	500	6 x 6.5"	3	1250
HADO/11	HP7	500	6 x 8"	4	1000
HADO/12	HP8	500	6.5 x 7"	4	1000
HADO/13	HP9	500	7 x 9"	5	800
HADO/02	HP10	500	8 x 8"	6	700
HADO/03	HP12	500	9 x 7.5"	8	700
HADO/04	HP13	500	9 x 9"	10	600
HADO/05	HP14	500	10 x 10"	13.5	500
HADO/06	HP15	500	12 x 12"	17	400
HADO/07	HP16	500	15 x 15"	36	200

Propagating Plugs

FERTISS Plugs - Without Tray

FERTISS is a ready to use propagation plug for young or in vitro plants. The substrate is retained by a nonwoven paper. The roots can go through the paper. From this moment, the young plant can be transplanted.

Fertiss plugs are delivered in cases, ready to be placed in your trays.



Code	Reference	Cell Dimension	Cell Volume	Packaging Type	Pack Qty	Cases Per Pallet
FERT471	471.20	2cm x 4cm	12cm ³	Case	2376	54
FERT473	473.10	3.2cm x 3.5cm	28cm ³	Case	1053	54
FERT475	475.10	3cm x 3cm	18cm ³	Case	1560	54
FERT475T	475.15	3cm x 5cm	30cm ³	Case	936	54
FERT476	476.10	4cm x 4cm	40cm ³	Case	684	54
FERT477	477.10	4cm x 6cm	60cm ³	Case	456	54
FERT478	478.10	4cm x 8cm	80cm ³	Case	342	54

Polythene Pots

FERTISS Plugs - With Tray

A huge choice of tray specifically designed for FERTISS plugs.

The selected trays have cells that allow air and water flow optimally around the plugs. Different densities of plant are possible, with for example, exclusive breakable trays.

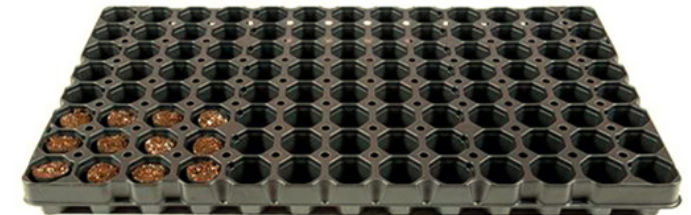

Code	Reference	No Of Cells	Cell Dimension	Cell Volume	Packaging Type	Pack Qty
FERT431C	431..C	150	2cm x 4cm	12cm ³	Case	2100
FERT431	431.40	150	2cm x 4cm	12cm ³	Pallet	57600
FERT440C	440.C	104	3cm x 3cm	18cm ³	Case	1768
FERT440P	440.40	104	3cm x 3cm	18cm ³	Pallet	49920
FERT446C	446.C	104	3cm x 5cm	30cm ³	Case	1144
FERT446P	446.40	104	3cm x 5cm	30cm ³	Pallet	33280
FERT447P	447.40	84	3cm x 3cm	18cm ³	Pallet	44352
FERT456	456.C	60	4cm x 4cm	40cm ³	Case	840
FERT456P	456.40	60	4cm x 4cm	40cm ³	Pallet	24960
FERT456D.C	456D.C	60	4cm x 6cm	60cm ³	Case	540
FERT456DP	456D.40	60	4cm x 6cm	60cm ³	Pallet	15360
FERT465C	465.C	84	3.2cm x 3.5cm	28cm ³	Case	1260
FERT465P	465.40	84	3.2cm x 3.5cm	28cm ³	Pallet	40320

Peat Pellets

Jiffy-7®

Fine netting is filled with high quality substrate and then compressed to form a Jiffy-7® pellet. Just add water, and the pellet grows up to seven times its size in just a few moments. It is held together by the fine netting, ensuring optimum air/water exchange.



Code	Reference	Diameter	Pack Qty
JIFFY/05	321 701 42	44mm	1000
JIFFY/04	321 701 38	41mm	1000
JIFFY/03	311 301 05	33mm	2000
JIFFY/02	700 001 65	25mm	3312
JIFFY/01	311 221 24	24mm	2000

Biodegradable Pots

FERTILPOT

FERTILPOT is 100% made of wood fibres, does not contain any chemical and is approved for use in organic farming. It is plant-able and perfectly natural.

It is suitable for ornamentals, vine nursery, forestry, as well as home gardeners. Its porosity to water and air as well as its resistance during cultivation make it a truly one-of-a-kind pot.

= Destacking Lug



Code	Description	Dimension	Capacity	Pack Qty
FERT504	Round Pot	6cm x 6cm	110cm ³	3000
FERT504PF	Peat Free Round Pot	6cm x 6cm	110cm ³	3000
FERT510	Round Pot	8cm x 8cm	320cm ³	1370
FERT510PF	Peat Free Round Pot	8cm x 8cm	320cm ³	1370
FERT511*	Round Pot	8cm x 8cm	320cm ³	1100
FERT511PF	Peat Free Round Pot	8cm x 8cm	320cm ³	1100
552.1C	Square Pot	8cm x 8cm	300cm ³	864
Strip-18 Pots	Strip	6cm x 6cm	110cm ³	1998
FERT552.C	Strip -12 Pots	8cm x 8cm	300cm ³	768

Pots & Trays

Vertical Planters

Vertical Planter System

The Vertical Planter system is a self-watering wall planter. It is 46cm long. Plants can be placed in their pots (up to 12cm) or planted directly into compost using the planting tray.

The roots are kept constantly damp by the reservoir of water in the base. Running an irrigation pipe along the top row of planters, allows the water to flow into them and then when the reservoir is full it overflows to the one below.

The planters are designed to be easily applied to walls in a variety of methods. They can be clipped securely onto 50mm welded mesh or screwed onto vertical or horizontal wooden laths. Designed to be spaced 20cm above each other leaves plenty of space for plants to grow and hide the planter.



Code	Description	Pack Size
GW1	Vertical Planter	30
GWCLIP	Clip for mesh installation	Each

Decorative Planters

Cask Planters





Code	Size (cm)	Description	Volume (lt)	Colour	Pack Qty
Cask Planter 10"					
CTCK10C	25 x 16.76	Without Band	6	Chestnut	10
CTCK10CB	25 x 16.76	With Band	6	Chestnut	10
CTCK10D	25 x 16.76	Without Band	6	Driftwood	10
CTCK10DB	25 x 16.76	With Band	6	Driftwood	10
CTCK10G	25 x 16.76	Without Band	6	Grey	10
CTCK10GB	25 x 16.76	With Band	6	Grey	10
Cask Planter 12"					
CTCK12CB	30 x 20.32	With Band	9	Chestnut	10
CTCK12DB	30 x 20.32	With Band	9	Driftwood	10
CTCK12G	30 x 20.32	Without Band	9	Grey	10
CTCK12GB	30 x 20.32	With Band	9	Grey	10
Cask Planter 16"					
CTCK16CB	40 x 27.94	With Band	14.5	Chestnut	Each
CTCK16DB	40 x 27.94	With Band	14.5	Driftwood	Each
CTCK16GB	40 x 27.94	With Band	14.5	Grey	Each

Pots & Trays

Decorative Planters

Tuscany Roman Round				
				
Code	Size (cm)	Volume (lt)	Colour	Pack Qty
Tuscany Roman 10"				
ROMAN-25-AM	25 x 23	6.85	Aged Mesquite	10
ROMAN-25-BB	25 x 23	6.85	Black Bronze	10
ROMAN-25-CO	25 x 23	6.85	Copper	10
ROMAN-25-S	25 x 23	6.85	Silver	10
ROMAN-25-VG	25 x 23	6.85	Verdigris	10
Tuscany Roman 13.5"				
ROMAN-34-AM	34 x 25	11.5	Powdered Terracotta	Each
ROMAN-34-BB	34 x 25	11.5	Black Bronze	Each
ROMAN-34-CO	34 x 25	11.5	Copper	Each
ROMAN-34-S	34 x 25	11.5	Silver	Each
ROMAN-34-VG	34 x 25	11.5	Verdigris	Each
Tuscany Roman 17.8"				
ROMAN-46-AM	46 x 35	29	Aged Mesquite	Each
ROMAN-46-BB	46 x 35	29	Black Bronze	Each
ROMAN-46-CO	46 x 35	29	Copper	Each
ROMAN-46-S	46 x 35	29	Silver	Each
ROMAN-46-VG	46 x 35	29	Verdigris	Each

Tuscany Square 14.3"				
				
Code	Size (cm)	Volume (lt)	Colour	Pack Qty
CTTSAB	36 x 30	30	Aged Black	Each
CTTSBB	36 x 30	30	Black Bronze	Each
CTTSAM	36 x 30	30	Aged Mesquite	Each

Tuscany Window Box				
				
Code	Size (cm)	Volume (lt)	Colour	Pack Qty
Tuscany Window Box 20.5"				
CTTWAB	51 X 24	21	Aged Black	Each
CTTWAM	51 X 24	21	Terracotta	Each
CTTWBB	51 X 24	21	Black Bronze	Each
Tuscany Window Box 30"				
CTTW2AB	75 X 24	33	Aged Black	Each
CTTW2T	75 X 24	33	Terracotta	Each
CTTW2BB	75 X 24	33	Black Bronze	Each

Pots & Trays

Tuscany Tall Square



Code	Size (cm)	Volume (lt)	Colour	Pack Qty
Tall Square 11"				
CTTSAB	27 x 33	15	Aged Black	Each
CTTSBB	27 x 33	15	Black Bronze	Each
Tall Square 15"				
CTTTSAB	38 x 42	43	Aged Black	Each
CTTTSAM	38 x 42	43	Aged Mesquite	Each
CTTTSBB	38 x 42	43	Black Bronze	Each
CTTTSKO	38 x 42	43	Copper	Each

Flower Bag - Jute

Easy to use alternative to hanging baskets, place plants into slots and hang from bracket or hook, suitable for most plant types.

Width: 23cm
Height: 55cm

Code	Colour	Unit Of Sale
FLOW	Green	60



Leonardo Series



Code	L x W x H (cm)	Volume (lt)	Colour	Pack Qty
Leonardo Trough 15"				
CTTR38T	38 x 20 x 14	7.75	Terracotta	10
CTTR38B	38 x 20 x 14	7.75	Black	10
Leonardo Trough 24"				
CTTR60T	60 x 19 x 17	13.92	Terracotta	Each
CTTR60B	60 x 19 x 17	13.92	Black	Each
Leonardo Trough 30"				
CTTR76T	76 x 19 x 17	15.5	Terracotta	Each
CTTR76B	76 x 19 x 17	15.5	Black	Each
Leonardo Trough 40"				
CTTR100T	100 x 19 x 17	23.5	Terracotta	Each
CTTR100B	100 x 19 x 17	23.5	Black	Each

Hanging Baskets

Wicker Baskets - Round & Cone

Salim & Corn Leaf Rope Round



Code	Size	Pack Qty
HB-12-WICK-RD/18	12"	20
HB-14-WICK-RD/12	14"	20

Natural Moss Round



Code	Size	Pack Qty
HB-12-WICK-RD/01	12"	20
HB-14-WICK-RD/01	14"	20

Swirl Rope & Reed Round



Code	Size	Pack Qty
HB-12-WICK-RD/03	12"	20
HB-14-WICK-RD/04	14"	20

Sugar Cane Round



Code	Size	Pack Qty
HB-12-WICK-RD/04	12"	20
HB-14-WICK-RD/05	14"	20

Rope & Bark Round



Code	Size	Pack Qty
HB-12-WICK-RD/06	12"	20
HB-14-WICK-RD/07	14"	20

Brushwood & Seagrass Round



Code	Size	Pack Qty
HB-12-WICK-RD/20	12"	20
HB-14-WICK-RD/14	14"	20

Black Rattan



Code	Size	Pack Qty
HB-10-WICK-RD/01	10"	20
HB-12-WICK-RD/10	12"	20
HB-14-WICK-RD/20	14"	20
HB-16-WICK-RD/02	16"	20

White Willow & Rattan Round



Code	Size	Pack Qty
HB-12-WICK-RD/12	12"	20
HB-14-WICK-RD/21	14"	20

Black 3 Tone Pattern Round



Code	Size	Pack Qty
HB-12-WICK-RD/14	12"	20
HB-14-WICK-RD/23	14"	20

Banana Rope Weave Round



Code	Size	Pack Qty
HB-12-WICK-RD/15	12"	20
HB-14-WICK-RD/24	14"	20

Palm Light Rope Round



Code	Size	Pack Qty
HB-12-WICK-RD/16	12"	20
HB-14-WICK-RD/25	14"	20

Light 3 Tone Pattern Round





Code	Size	Pack Qty
HB-12-WICK-RD/17	12"	20
HB-14-WICK-RD/11	14"	20

Hanging Baskets

Wicker Baskets - Round & Cone

Slim 3 Corn Leaf Rope Cone		
		
Code	Size	Pack Qty
HB-12-WICK-CONE/20	12"	20
HB-14-WICK-CONE/19	14"	20

Brushwood & Corn Leaf Rope		
		
Code	Size	Pack Qty
HB-12-WICK-CONE/13	12"	20
HB-14-WICK-CONE/22	14"	20

Swirl Rope & Reed Cone		
		
Code	Size	Pack Qty
HB-12-WICK-CONE/03	12"	20
HB-14-WICK-CONE/02	14"	20

Sugar Cane Cone		
		
Code	Size	Pack Qty
HB-12-WICK-CONE/04	12"	20
HB-14-WICK-CONE/12	14"	20

Rope & Bark Cone		
		
Code	Size	Pack Qty
HB-12-WICK-CONE/06	12"	20
HB-14-WICK-CONE/04	14"	20

Brushwood & Seagrass Cone		
		
Code	Size	Pack Qty
HB-12-WICK-CONE/10	12"	20
HB-14-WICK-CONE/21	14"	20

Black Rattan Cone		
		
Code	Size	Pack Qty
HB-12-WICK-CONE/12	12"	20
HB-14-WICK-CONE/11	14"	20

White Willow & Rattan Cone		
		
Code	Size	Pack Qty
HB-12-WICK-CONE/14	12"	20
HB-14-WICK-CONE/13	14"	20

Black 3 Tone Pattern Cone		
		
Code	Size	Pack Qty
HB-12-WICK-CONE/16	12"	20
HB-14-WICK-CONE/15	14"	20

Banana Rope Weave Cone		
		
Code	Size	Pack Qty
HB-12-WICK-CONE/17	12"	20
HB-14-WICK-CONE/16	14"	20

Palm Light Rope Cone		
		
Code	Size	Pack Qty
HB-12-WICK-CONE/18	12"	20
HB-14-WICK-CONE/17	14"	20

Light 3 Tone Pattern Cone		
		
Code	Size	Pack Qty
HB-12-WICK-CONE/19	12"	20
HB-14-WICK-CONE/18	14"	20

Hanging Baskets

TEKU®

Plastic Hanging Baskets

MAL - Hanging Pot

Available in anthracite, blackberry, pine green, light green, orange, petrol blue, pink, red, terracotta, white, & yellow.

This pot does not come with hangers, see MHB hangers.



Reference	Diam (cm)	Height (cm)	Volume (lt)	Hanger	Pack Qty
MAL 20	20	13.4	3	MHB 33	46
MAL 25	25	15.4	5	MHB 45	46
MAL 27	27	16.4	6	MHB 45	46

TCA - Hanging Pot

Available in anthracite, blackberry, pine green, light green, orange, petrol blue, pink, red, terracotta, white, & yellow.

This pot does not come with hangers, see A 60 hangers.



Reference	Diam (cm)	Height (cm)	Volume (lt)	Hanger	Pack Qty
TCA 30	30	18.3	7.7	A 60	38

A & MHB - Hangers

Available in anthracite, blackberry, pine green, light green, orange, petrol blue, pink, red, terracotta, white, & yellow.

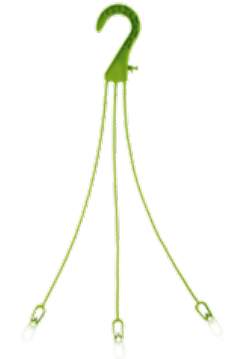

Reference	Length	Hook Diam (mm)	Use With Basket	Pack Qty
A 60	60	38	TCA 30	38
MHB 33	33	35	MAL20	46
MHB 38	38	35	MAL25	46
MHB 45	45	35	MAL27	46

Standard Colours



Trend Colours



TEKU®

Hanging Baskets

NJ - Pot + Hanger

Eco-designed hanging baskets with raised cross-bottom with water reserve to ensure an optimal drainage when cultivated on the ground.

- 12 standard colours available
- Glossy surface
- 2 Slots for labels and carry handles

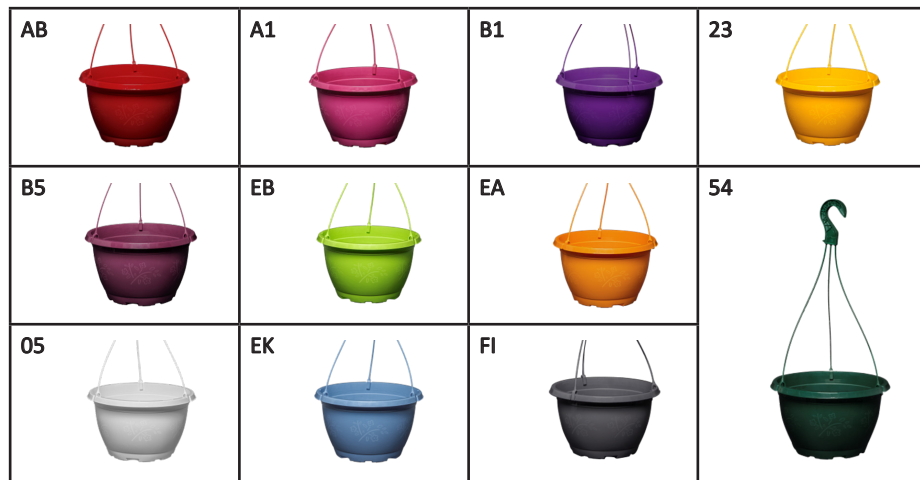

Supplier Reference	Volume	Ext Ø x H (cm)	Available Colours												Case Qty
			AB	A1	B1	23	B5	EB	EA	CF	05	EK	FI	54	
7356	5lt	25 x 15.4	✓	✓	✓	✓	✓	✓	✓	✓	✓	✓	✓	✓	96
7361	6lt	27 x 16.2	✓	✓	✓	✓	✓	✓	✓	✓	✓	✓	✓	✓	96

Octo- Pot + Hanger

These hanging baskets are rigid and solid, have an octagonal shape and a water reserve bottom. The hanger has a safety system of attachment with double clamp which is easy to position thanks to a visual identification for the clipping of the hanger (versions Ø 25 to 30 cm). Available in various shiny colours. Our stocked colour is green.



Code	Reference	Colour	Colour Ref	Volume (lt)	Ext Ø x H (cm)	Case Qty
HB-30-PLAS/08	73931005	White	05	10	30 x 20.5	35
HB-30-PLAS/06	73931017	Terracotta	17	10	30 x 20.5	35
HB-30-PLAS/07	73931954	Pine Green	54	10	30 x 20.5	35
HB-27-PLAS/41	73911005	White	05	7	27 x 18.4	56
HB-27-PLAS/23	73911017	Terracotta	17	7	27 x 18.4	56
HB-27-PLAS/42	73911954	Pine Green	54	7	27 x 18.4	56

Hanging Baskets



County Hanging Basket

Black plastic County hanging basket.

- Flat base for extra stability during planting
- Built in saucer for better water retention
- Flexible Bars for easier side planting
- Attractive matt finish
- Chains sold separately, see below
- Colour: Black



Code	Reference	Volume (lt)	Ext Ø x H (cm)	Case Qty	Pallet Qty
HB-14-PLAS/01	COB14	11.5	36 X 20	20	640

County Hanging Basket Chain

Hanging basket chain for the county hanging basket.



Code	Reference	Description	Length (cm)	No Legs	To Fit	Pack Qty
CHAIN/03	CH4T	Basket Chain	42	4	COB14	20

Easy Grow Baskets

Easy Grow Green



Code	Size	Pack Qty
HB-12-PLAS/02	12"	32
HB-14-PLAS/04	14"	24

Easy Grow Black



Code	Size	Pack Qty
HB-12-PLAS/01	12"	32
HB-14-PLAS/02	14"	24

Easy Grow Wall



Code	Colour	Size	Pack Qty
HB-20-PLAS/01	Black	20"	20
HB-20-PLAS/02	Green	20"	20

Hanging Baskets

Self-Watering Baskets & Planters

Cup & Saucer Hanging Basket

Unlike traditional hanging baskets, these self-watering baskets do not leak; they minimise evaporation and only need to be watered once or twice a week. In short, they save time, water and money!



Code	Diameter	Depth	Pack Qty
CAS-0P	410mm	240mm	Each
CAS-1P	530mm	265mm	Each



Up-the-Pole Baskets

Fabulous, easy-to-mount units that can be safely secured to almost any pole, post or bollard using sturdy brackets.



CUH



UTP



TUH



CNS

Code	Description	Diameter	Depth	Pack Qty
CUH-1P	Up-the-Pole basket	470mm	270mm	Each
CUH-1P	Up-the-Pole basket	590mm	270mm	Each
CUH-1P	Up-the-Pole basket	800mm	270mm	Each
TUH-1P	Up-the-Pole basket (New shape)	500mm	300mm	Each
TUH-2P	Up-the-Pole basket (New shape)	650mm	300mm	Each
TUH-3P	Up-the-Pole basket (New shape)	820mm	310mm	Each
UTP-1P	Half Unit Up-the-Pole Basket	590mm	270mm	Each
UTP-2P	Half Unit Up-the-Pole Basket	800mm	270mm	Each
CNS-1P	Cup and Saucer Up-the-Pole Basket	650mm	300mm	Each

Hanging Baskets

Wire Baskets

Growers Basket



Code	Size	Pack Qty
HB-12-WIRE/06	12"	25
HB-14-WIRE/06	14"	25
HB-16-WIRE/07	16"	25

Heavy Duty 4 Chain Basket



Code	Size	Pack Qty
HB-18-WIRE/02	18"	12
HB-20-WIRE/10	20"	12

Hanging Basket Brackets

Traditional hanging basket bracket.
Available in 4 sizes.



Code	Size	Pack Qty
BRACKET/01	12"	24
BRACKET/02	14"	24
BRACKET/03	16"	24
BRACKET/04	20"	6

Basket Liners

Hemp Moss

Hemp Moss is a sustainable hanging basket material that is far more durable than traditional sphagnum moss.

- Can absorb 10 times its weight in water
- 5kg makes up to 15 x 14" baskets
- Cheaper than moss in comparison
- Can be re-used
- Sustainable product
- Environmentally friendly paper packaging
- Excellent re-wetting characteristics



Code	Pack Size
MOSS-HEMP/01	5kg

Hanging Baskets

Sphagnum Moss	
Premium quality natural moss for lining hanging baskets. Moss is extremely long lasting and is highly water absorbent making it ideal for creating green mossed hanging baskets.	
Code	Bag Size
MOSS/01	2ft x 1ft



Jute Moss On A Roll		
Biodegradable green jute liner on a roll.		
Code	Size	Pack Qty
MOSS/02	1m x 75m	Each
MOSS/07	60cm x 60m	Each



Woolmoss	
Wool moss for lining hanging baskets.	
Code	Pack Size
MOSS/08	10kg



Pre Cut Jute Liners		
Made from 100% recycled fibre and probably one of the quickest and easiest ways to line a hanging basket.		
Code	Size	Pack Qty
LINER/12	12"	100
LINER/13	14"	100
LINER/14	16"	100
LINER/15	18"	100



Coco Liners		
Pre shaped for convenience, these liners are made from long lasting coco fibres with a latex coating.		
Code	To Fit Basket Size	Pack Qty
LINER/02	12"	60
LINER/03	14"	50
LINER/04	16"	45
LINER/05	18"	30



Pre Cut Wool Liners		
An excellent water absorbing and retaining liner for hanging baskets. Moulds into any shaped basket or pot.		
Code	Size	Pack Qty
LINER/16	12"	100
LINER/17	14"	100
LINER/18	16"	100
LINER/19	18"	100

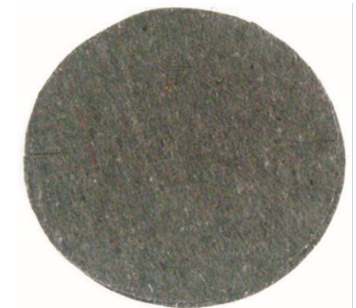

Plant Labels & Growers Sundries

Plant Labelling

PVC & Vinyl Loop Lock & Stick Labels				
Product	Length	Writing Area	Colour	Qty/Roll
LL5 (PVC)	16cm	11 x 1.6cm	White/Yellow/Green/Red/Blue/ Pink/Orange	1000
LL8 (PVC)	22cm	15 x 2.5cm	White/Yellow/Green/Red/Blue/ Pink/Orange	1000
LL6 (Vinyl)	16cm	11 x 1.6cm	White/Yellow/Green/Red/Blue/ Pink/Orange	1000
LL10 (Vinyl)	22cm	15 x 2.5cm	White/Yellow/Green/Red/Blue/ Pink/Orange	1000
LL9 (COMP)	22cm	15 x 2.5cm	(For inkjet printer) White	1000
LL21 200 Micron	14cm	14 x 1.9cm	(For inkjet printer) White	1000

Thermal Print Loop Lock Labels

All loop lock labels come in 3,4,5,6 labels wide with the narrow edge leading. Please specify number of labels wide when placing your order.

Product	Length	Writing Area	Colour	Qty/Roll
LL30	19cm	9.5 x 1.9cm	White	2000
LL31	23cm	230mm x 25mm	White	2000

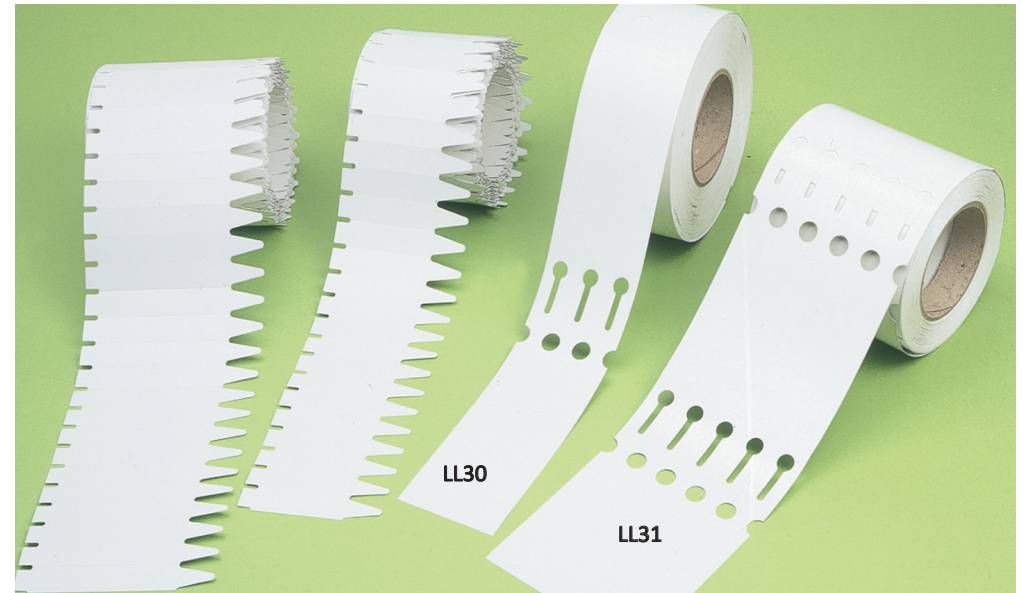
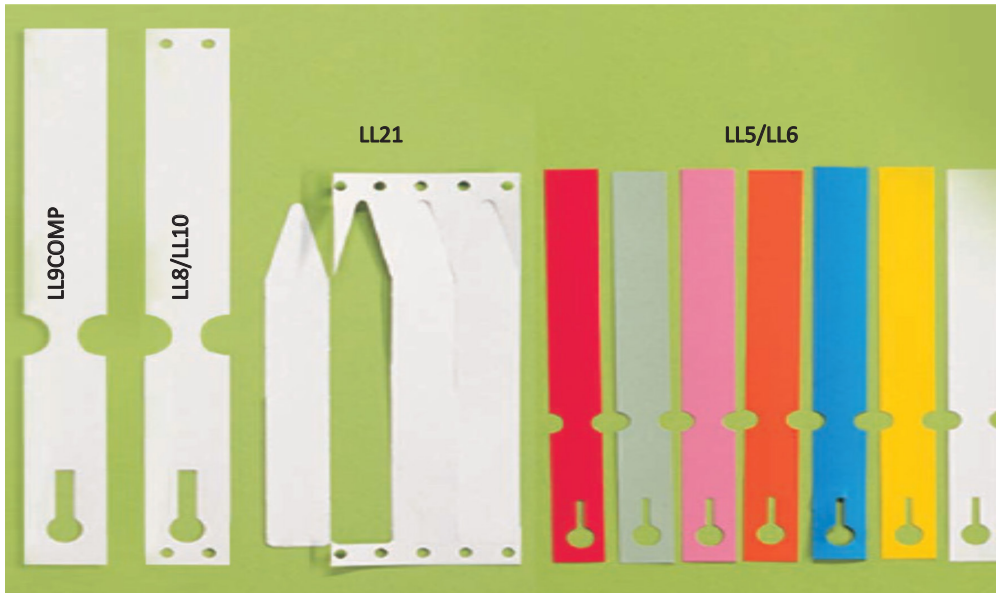

Plant Labels & Growers Sundries

Tyvek Loop Lock Computer Labels

These labels are fan folded for use with inkjet printers.

Product	Length	Writing Area	Colour	Qty/Roll
LL1819W	18cm	9.5 x 1.9cm	White	1000
LL2225W	22cm	15 x 2.5cm	White	1000
LL2225B	22cm	15 x 2.5cm	Blue	1000

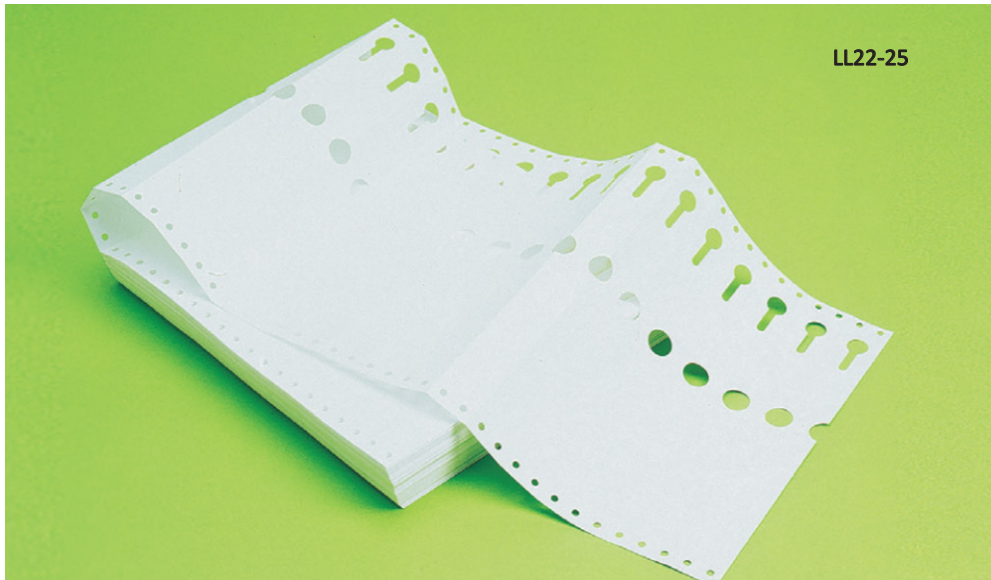

Marker Pens



Code	Description	Colour	Pack Qty
PENS/13	Staedler Fine/Medium Double Headed Marker Pens	Black	10
PENS/01	Staedler Pens (Medium Point)	Black	10
PENS/01F	Staedler Pens (Fine Point)	Black	10
PENS/10	Sharpie Medium Point Pens	Black	10
PENS/09	Sharpie Fine Point Pens	Black	12
PENS/03	Artline 70 Medium Point Pens	Black	12
PENS/02	Artline 90 Medium Point Pens	Black	12
PENS/08	Artline 250 Fine Point Pens	Black	12
PENS/06	Artline 47 Wetrite Pens	Black	12
PENS/14	Artline Garden Marker	Black	12
PENS/04	Artline Chalk Marker Pens	White	12
PENS/12	Liquid Chalk Pens (Showerproof)	White	2

Plant Labels & Growers Sundries

Plant Labelling

Heavy Duty Pot & Stake Labels				
Standard colour: White. 10cm (4") also available in: Yellow, Green, Orange, Blue, Purple, Red, Pink, Beige, Grey, Brown, Black. 12cm (5") also available in: Yellow, Green, Orange, Blue, Purple, Red, Pink, Black.				
Code	Colour	Length	Writing Area	Qty/Roll
L4	White	10cm (4")	10 x 1.4cm	1000
L5	White	12cm (5")	12.5 x 1.4cm	1000
L6	White	15cm (6")	15 x 1.7cm	1000
L8	White	20cm (8")	20 x 1.9cm	500
L8-EP	White	20cm (8")	20 x 1.9cm	250
L10	White	25cm (10")	25 x 2.5cm	50
EL12	White	30cm (12") Standard Duty	30 x 3cm	50
EL16	White	40cm (16") Standard Duty	40 x 3cm	50
EL20	White	50cm (20") Standard Duty	50 x 3cm	50
EL24	White	60cm (24") Standard Duty	60 x 3cm	50
L12	White	30cm (12") Heavy Duty	30 x 3.8cm	50
L16	White	40cm (16") Heavy Duty	40 x 3.8cm	50
E20	White	50cm (20") Heavy Duty	50 x 3.8cm	50
E24	White	60cm (24") Heavy Duty	60 x 3.8cm	50

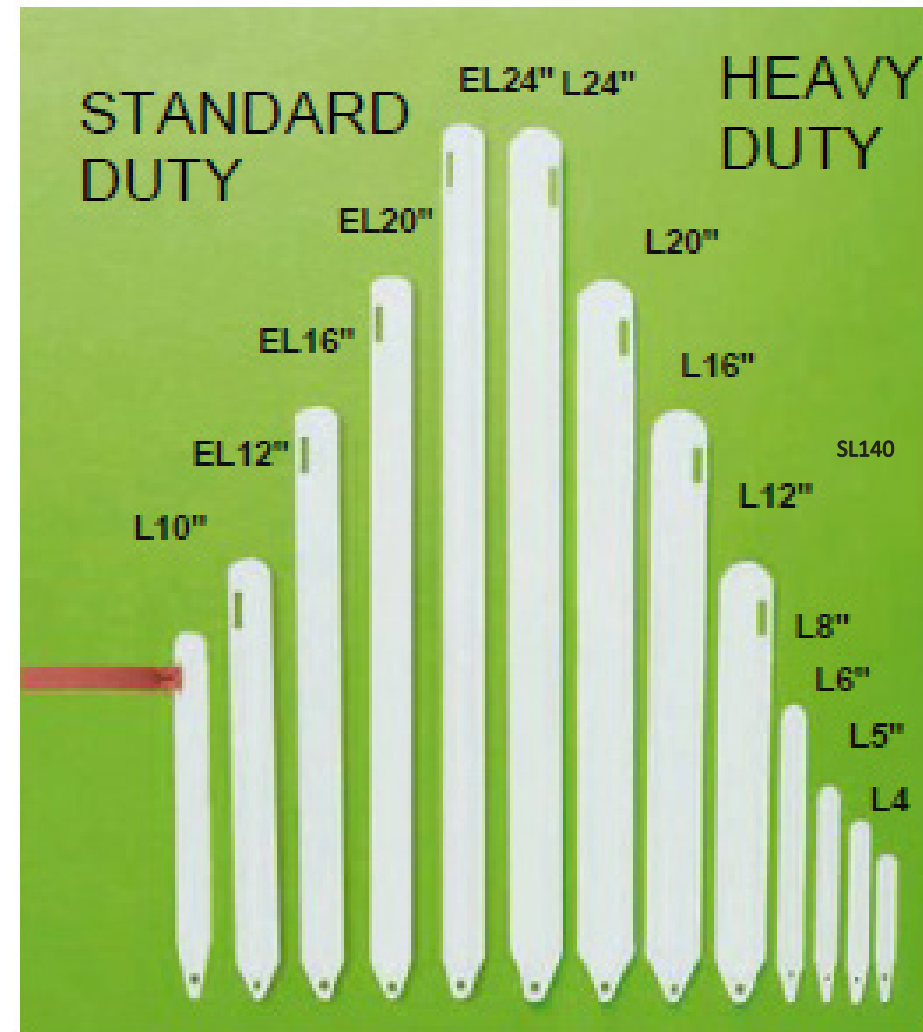

Plant Labels & Growers Sundries

Flower Bucket Labels

The SL280 and SL290 bucket labels will clip onto the rim of most buckets, and will stay on securely. Ideal for pricing cut flowers.

Product	Length	Writing Area	Colour	Pack
SL280	22cm	9 x 6cm	White / Black	25
SL290	50cm	16 x 10cm	Black Board	25
SL291	42cm	12.5 x 8cm	Black Board	25
SL435	42cm	12.5 x 8cm	Black Board	25
SL495	50cm	16 x 10cm	Black Board	25



Info Sticks

Info sticks hold picture labels either vertically or at 45 degrees. Each label is very easily and quickly clipped into position. The label is securely held and will not spin, be blown or pulled out easily.

Product	Length	Pack
IF6	17cm	3,000
IF11	30cm	5,000
IF15	39cm	3,000
IF24	60cm	1,000
IFRing		1,000
IFClip		1,000
IF11QC	28cm	2,500
IF15QC	38cm	1,500



Plant Labelling

Angled Head Labels				
Product	Length	Writing Area	Colour	Qty/Roll
SL160	16cm	5 x 4cm	White / Yellow/Green/Black	50
SL190	19cm	7.5 x 5cm	White / Yellow/Green/Black	50
SL190BB	19cm	7.5 x 5cm	Blackboard	50
SL275	27cm	13 x 8cm	White / Yellow/Black/Blue/Red	50
SL275BB	27cm	13 x 8cm	Blackboard	50
SL279	28cm	16 x 10cm	White / Yellow	50
SL279BB	28cm	16 x 10cm	Blackboard	50
SL400	38cm	10 x 6cm	White/Beige/Green/Blue/Red/Black/Yellow	50
SL440 BB	43cm	12.5 x 8cm	Blackboard	50
SL440	44cm	12.5 x 8cm	White/Yellow/Black	50
SL500	53cm	16 x 10cm	White / Yellow/Black	25
SL500 BB	53cm	16 x 10cm	Blackboard	25
SL650	71cm	19 x 12cm	White/Yellow/Black	25
SL650BB	57cm	19 x 12cm	Blackboard	25

Base: 11cm x 15cm for use with SL275,SL400, SL440 & SL500 (Black). Pack qty 25.



Plant Labels & Growers Sundries

T Labels				
Product	Length	Writing Area	Colour	Qty/Roll
SL55	6.5cm	5 x 4cm	White/ Yellow	100
SL80	8cm	10 x 5.5cm	White	100
SL135	15cm	5.5 x 3.5cm	12 Colours**	500
SL138	15.5cm	4 x 3cm	White/Black	500
SL200	20cm	8 x 5cm	White/Black/Yellow	100
SL201	15cm	8 x 5cm	White/Yellow	100
SL250	24cm	10 x 6cm	White/Green/Beige/Black/Red/Blue/ Yellow	100
SL300	30cm	8 x 5cm	White/Yellow/Green/ Orange/Red/ Purple/Pink/Black/Blue	100
SL340	33cm	10 x 6cm	White/Black/Beige/Yellow	100
SL445	45cm	12 x 8cm	White/Yellow/Beige	50
SL545	54cm	15 x 10cm	White/Yellow/Beige	50
SL735	74cm	20 x 12.5cm	Yellow	25

Card Holder Range

Telescopic Adjustable Card Holders				
Code	Description	Card Size	Head Style	Pack
SL800	Adj. Card Holder	8" x 6"	Angled (Landscape)	25
SL811	Adj. Card Holder	8" x 6"	Flat (Landscape)	25
SL805	Adj. Card Holder	A4 (210mmx297mm)	Angled (Landscape)	25
SL806	Adj. Card Holder	A4 (210mmx297mm)	Angled (Portrait)	25
SL807	Adj. Card Holder	A5 (210mmx148.5mm)	Angled (Landscape)	25
SL816	Adj. Card Holder	A6 (105mmx148.5mm)	Angled (Landscape)	25
SL808	Adj. Card Holder	A5 (210mmx148.5mm)	Flat (Landscape)	25
SL905	Adj. Card Holder	11" x 7"	USA Flat	25
SL906	Adj. Card Holder	11" x 7"	USA Angled	25
SL907	Adj. Card Holder	8 1/2" X 11"	USA Angled	25

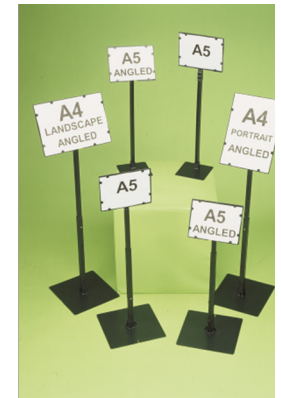
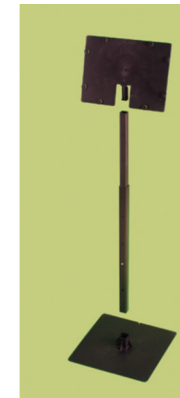

Plant Labels & Growers Sundries

Card Holder Range

Bench Stands—Non Adjustable				
Code	Description	Card Size	Head Style	Pack
SL801	Bench Stand	8" x 6"	Flat (Landscape)	25/ pack
SL804	Stand	8" x 6"	Angled (Landscape)	25
SL809	Stand	A5 (210mmx148.5mm)	Angled (Landscape)	25
SL810	Bench Stand	A5 (210mmx148.5mm)	Flat (Landscape)	25
SL812	Stand	A5 (210mmx148.5mm)	Flat (Portrait)	25
SL813	Stand	A5 (210mmx148.5mm)	Angled (Portrait)	25



The **SL801** has a flat head which can display a card on both sides. It stands 22" (55cm) high so it is ideal for benches, etc. SL804 is the same dimensions, but with an angled head. Comes in a set of three separate pieces. Also in A5 versions and US sizes.



Card Holders
<p>SL450 / SL415 (25/Pack) Will hold 2" x 2" (5cm x 5cm) cards or up to postcard size and so is ideal for holding price cards. SL450 stands 30cm high.</p> <p>SL415 stands 23cm high.</p> <p>SL465 (25/Pack) Will hold 5" x 7" picture card. 50cm with no limitations.</p> <p>SL475 (25/Pack) Will hold 8" x 6" picture card. 50cm with no limitations.</p>



Card Holder - SL601
<p>SL601 (25/Pack)</p> <p>Designed to hold a 8" x 6" picture card securely. Can be wall mounted or for bench top use, like a photo frame by just pressing out the centre section and clipping it into the back of the holder.</p> <p>Suitable for indoor and outdoor use.</p>



Plant Labels & Growers Sundries

Card Holders - SL602, SL604 & SL605

SL602 / SL604 (25/Pack)

These card holders are designed to clip onto the shelf of any Danish Trolley. They hold the picture cards securely and display them prominently. Just push the metal lip of the trolley under the two buttons, gently lift up and release the clip.

SL602: Holds 8" x 6" / A5 card. (25/Pack)

SL604: Holds A4 card. (25/Pack)

SL605: Holds 11"x 7" head. (25/Pack)



SL775

These card holders stand at 82cm high for use with A4, A5 Picture Cards - can be inserted into soil or used with a standard base. Appropriate for indoor use only. Pack Size: 25.



Mechanical Tying, Tapes & Soft Tubing

Max HTR Tying Machine & Tying Tape

The MAX hand tying machine is ideal for tying climbers, shrubs, trees and any other plants that require support. The machine applies a plastic tape around the plant and support to which it is tied, the tape is applied, stapled and cut simultaneously creating a loop. MAX TAPES PVC come in three gauges, 10 rolls per box.

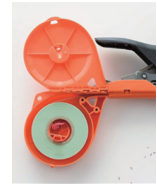

Product	Code
MAX HTR Scrap free New Generation / Lightweight	TYING/03
MAX Staples 604E-L (4,800 / box)	STAPLE/03
MAX Blades for the HTR Machine ONLY (2/pack)	BLADE/14
MAX Serrated Blades (3 per pack)	BLADE/03



Max Tape

Code	Product
TAPE-MAX/01	MAX Tying Tape No.10 Green (10 x 40m)
TAPE-MAX/06	MAX Tying Tape No.10 White (10 x 40m)
TAPE-MAX/02	MAX Tying Tape No.15 Green (10 x 26m)
TAPE-MAX/03	MAX Tying Tape No.25 Green (10 x 16m)
TAPE-MAX/04	MAX Tying Tape No.25 Red (10 x 16m)



Plant Labels & Growers Sundries

Soft Tying Tube

Soft tying tube is ideal for soft fruits, vines, fruit trees and shrubs.



Code	Description	Unit Size
TYING/07	3mm Brown Tube for use with HRF or hand tying	150m
TYING/08	3mm Green Tube for use with HRF or hand tying.	150m
TYING/05	4mm Green Tube for use with HRF or hand tying.	320m
TYING/06	5mm Green Tube for use with HRF or hand tying.	75m
TYING/09	6mm Green Tube for hand tying	200m

Max HR-F Tying Machine & Accessories

The Max HR-F is the option to go for when tape is not up to the job. Use with tying tube.



Code	Description	Unit Size
TYING/01	Max HR-F Tying Machine	Each
CLEAT	13mm x 5mm Cleats G130	1000
BLADE/13	Replacement Blades for HR-F	10

Growers Sundries

Cane Caps

Green cane caps are made from a rubber type material, they will fit most sizes of canes. A cane cap will cushion the impact against the face and will protect eyes from injury and spectacles from damage.

Due to its design the pyramid cane cap hold can hold 3 canes of various thickness to form a wigwam shape for climbers.



Code	Cane Type	Colour	Box Qty
CC1	For standard canes	Green / Yellow	1000
CC2	For thin canes	Green	1000
CC3	For split canes	Green	1000
CC4	Fits all canes	Green / Yellow	1000
CC5	For thick canes	Green	1000
PYR1		Green	1000

Plant Labels & Growers Sundries

Gro Triangles

The **GRO TRIANGLE** is designed to hold the canes upright creating a triangular column.
 The **GROT3 & 4** will hold a picture label securely.
 The **GROT2** takes variable diameters of canes.
GROT1 is best with split canes.

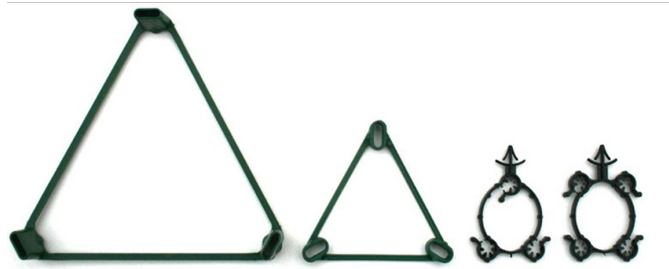

GROT2

GROT1

GROT3

GROT4



Code	Cane Type	Diameter	Box Qty
GROT1	3 Thin (Split canes)	9cm	500
GROT2	3 Thin	17cm	500
GROT3	3 Standard	5cm	500
GROT4	4 Standard	6cm	500

Plant Support Rings

PLANT SUPPORT RINGS fit onto any size cane and adjust up or down the cane as required.
 Because the circumference of the PS10 ring is in segments it is much easier to adjust plant stems as they are growing or cut flowers and damage to them is avoided. The PS62 is now with a solid ring format. Both rings are packed one on top of each other for faster usage and no snagging.



Code	Size	Box Qty
PS10	25cm diameter	100
PS12	30cm diameter	100
PS62	15cm diameter	250

Plant Labels & Growers Sundries

Growers Sundries

Tripods

Tripod legs are easily spread and inserted into soil. The legs have steps on them to give extra grip in the soil. The legs also have little protrusions along them so that the plant can grip and secure itself as it grows. The top acts as a cane cap and there is a lug so a label can be clipped on.

Code	Box Quantity
TR 18"	250
TR 24"	250
TR 32"	250
TR 39"	250



Plant Support Clips

The plant clip clips onto any normal split cane. It supports and guides the plant as it grows and is easily adjusted. Because it grips the cane, there is no tying involved. It is ideal for all types of floppy plants, climbers, bulbs, ivy, clematis, fressias and geraniums.

Code	Size	Box Quantity
PSC11	Medium 11cm	500
PSC85	Small 8.5cm	500



Trellis

The strengthened PS11 clips best onto the side of the rimmed square pots. It supports the plant during growth. Ideal for Ivy, Clematis and other climbers. The PS11 stands 20" (50cm) above the pot and is 30cm wide at the top.

PS16 stands 72cm above the pot. It has grips on the legs, so when inserted into the compost it will be stable and not be easily pulled out.

The plant could be then lifted by the trellis top. The PS17 is 17cm wide at the top and stands 55cm above the pot.



Code	Size	Box Quantity
PS11	60cm x 30cm	50
PSC16	85cm x 17cm	50
PS17	65cm x 17cm	50

Plant Labels & Growers Sundries

Cane Supports

Cane supports are designed to grip and hold canes upright and steady in most pots, thus preventing damage to plants. Just place the plant and cane into the pot before filling commences. The pot can also be lifted by the cane which will not detach. CBS 3 clips onto most pots after filling first, in a central or off centre mode.

CBS1



For Hand Filling

CBS3



For Machine Filling

Code	Box Quantity
CBS1	500
CBS3	500

Obelisks

The Obelisks are made to a classical design and to look like wrought iron. They have hook type grips on the bottom of their legs to achieve a secure hold in the compost. All the way up each leg are little legs sticking out about 10mm which allow climbers to attach easily and grow up the Obelisk. Ideal for any climbing plant. They are easily assembled by just clipping together the two frames and in the case of the Obelisk 1 pushing on the finial. Obelisk 1 has a diameter of 25cm and stands 96cm above the pot to the top of the finial.

Obelisk 2 has a diameter of 15cm and is 83cm long.

Obelisk 3 has a diameter of 15cm and is 65cm long.

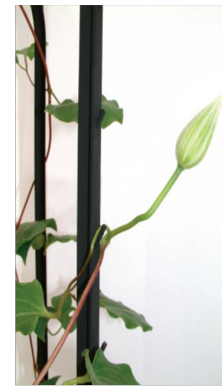

Code	Diameter	Height	Box Quantity
OB1	25cm	96cm	75
OB2	15cm	83cm	75
OB3	15cm	65cm	75

Plant Labels & Growers Sundries

Growers Sundries

Bamboo Canes

Over the last 20 years we have been importing bamboo canes from China, during this time we have gained valuable experience as to the requirements of the UK market. Because of this we only import the highest quality canes.



Code	Length	Cane Diameter	Approximate Weight of 100 Canes	Bale Size
CANE-2/03	2ft (60cm)	6-8mm	3-4lb	1000
CANE-3/05	3ft (90cm)	8-10mm	6-8lbs	500
CANE-3/08	3ft (90cm)	10-12mm	9-11lb	500
CANE-3/06	3ft (90cm)	12-14mm	9-11lb	250
CANE-4/02	4ft (120cm)	8-10mm	6-8lb	500
CANE-4/03	4ft (120cm)	12-14mm	18-20lb	250
CANE-4/01	4ft (120cm)	14-16mm	22-24lb	250
CANE-5/01	5ft (150cm)	12-14mm	24-26lb	250
CANE-6/01	6ft (180cm)	12-14mm	28-32lb	250
CANE-6/04	6ft (180cm)	14-16mm	30-34lb	200
CANE-6/02	6ft (180cm)	16-18cm	35-40lb	100
CANE-7/03	7ft (210cm)	14-16mm	36-40lb	200
CANE-8/04	8ft (240cm)	14-16mm	44-48lb	200
CANE-8/02	8ft (240cm)	18-20mm	59-64lb	100
CANE-8/03	8ft (240cm)	20-22mm	65-70lb	50
CANE-10/01	10ft (300cm)	22-24mm	74-80lb	50
CANE-12/02	12ft (360cm)	20-22mm	97-105lb	50
CANE-12/03	12ft (360cm)	22-24mm	104-115lb	50

Bamboo Trellis

Our bamboo trellis is made from the finest quality bamboo. Bespoke sizes available. Joints are drilled and not tied giving a tidy and strong finish.

Code	Length	Cane Diameter	Bale Size
TRELLIS/02	5ft (152cm)	12-14mm	25
TRELLIS/03	4ft (122cm)	12-14mm	50



Split Canes

Green split bamboo flower sticks.



Code	Length	Bale Size
CANE-12/01	12" (30cm)	5,000
CANE-18/01	18" (45cm)	2,500
CANE-24/01	24" (60cm)	2,500
CANE-30/01	30" (75cm)	1,250
CANE-36/01	36" (90cm)	1,250

Plant Labels & Growers Sundries

Securing Clips

Securing clips are designed to secure climbers, shrubs, roses, young trees to straining wires in growing beds or in retail areas.

By bending the clip around the plant or cane and clipping the clip onto the straining wire, this secures and protects the plant from being blown or knocked over.

Made from a black, weather resistant, durable plastic the securing clips are totally re-usable. They come in different sizes to fit different plants, trees and wire or rope gauges.

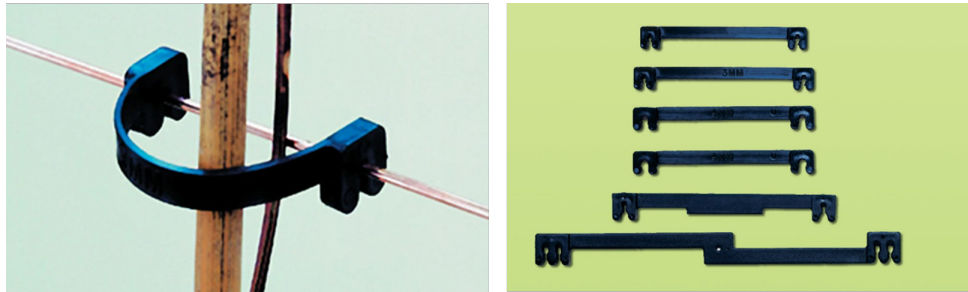

Code	Reference	Plant Type	Length	Wire Size	Pack Size
SECU/01	No52	Rose	10cm	2mm	500
SECU/02	No53	Fruit	12cm	3mm	500
SECU/03	No54	Tree	12cm	4mm	500
SECU/06	No55	Tree	15cm	4mm	500
SECU/07	No65	Tree	12cm	5mm	500
SECU/05	No60	Tree	22cm	3&4mm	500

Straining wire & Tensioners

Galvanised straining wire is ideal for creating plant support lines in growing beds or retail area. Other uses include supporting irrigation lines or creating a shade screen with products such as Monoplex Monofilament shade netting.



Code	Product Type	Diameter	Length	Unit Of Sale
81-35-05	Wire	2.5mm	130m	Each
81-35-25	Wire	2.5mm	650m	Each
WIRE/06	Wire	3.15mm	400m	Each
81-33-02	Wire Strainer/ Size 2	-	-	Each
81-33-03	Wire Strainer/ Size 3	-	-	Each

Anti Slip Cord

Anti slip cord is a simple and efficient method of tree and plant support. Best when used with securing clips.



Code	Diameter	Length
ANTI-SLIP/01	2mm	100m
ANTI-SLIP/02	3mm	100m
ANTI-SLIP/03	4mm	100m

Plant Labels & Growers Sundries

Growers Sundries

Pot Support Base		
<p>The Pot Support Base can hold most pots from 17cm upwards (2lt-8lt pots) and stops them from blowing over. Made from tough black polypropylene, pots are easily inserted and held firmly by flexible fingers, as shown in the image. The Pot Support Bases can be arranged in different patterns and attach to each other to create a rigid grid which is exceedingly stable in very windy conditions.</p>		
		
Code	Pot Size	Pack Size
PSB1	2lt-8lt	25

Pot Support Clips		
<p>The pot clip easily clips over thin rimmed pots and grips securely. When attached it keeps the pots stable and secure. It thus prevents accidental spillage or upsetting by the wind. The pot clips are made from a very durable, black polypropylene and are re-usable.</p>		
		
Code	Clip Size	Pack Size
PC4	4" (10cm)	100
PC6	6" (15cm)	100
PC9	9" (22cm)	100
PC12	12" (30cm)	100

Budding Clip		
<p>The Budding Clip is designed to be easily pushed onto a stem which it grabs tightly and directs the bud to grow upwards. Made from flexible black polypropylene it is reusable and is for stems of approximately 14-18mm in diameter.</p>		
		
Code	Stem Size	Pack Size
BC1	14-18mm	250

Plant Labels & Growers Sundries

Sheet & Fleece Pegs

Sheet pegs will keep all types of fleece securely in place. They are easy to use, made from a durable plastic and are totally reusable.

Simply drive the peg into the soil every 2m. The ends of the pegs are best earthed over.



SP1



SP2



SP4

Code	Length	Pack Size
SP1	15cm (prong)	50
SP2	20cm (prong)	250
SP2EP	20cm (prong)	100
SP3	16cm (prong)	250
SP4	16cm (prong)	250

Ground Cover & Mulch Mat Pegs

These pegs are ideal for holding down mulch mats or ground cover, in a variety of lengths with a wide head and shank. These pegs are made from a black or yellow durable plastic. Just gently tap in.

The yellow plastic washer fits all three heads. Use a rubber mallet or protect the head with a timber block when driving into the soil.

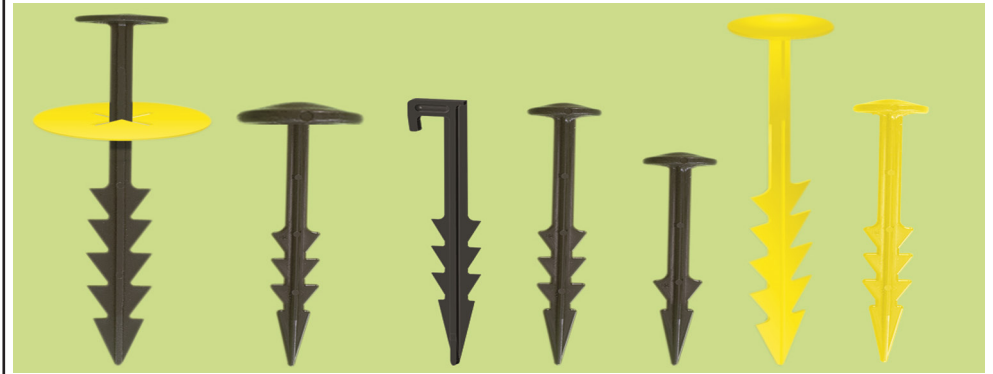

MMP3

MMP4

MMP5

MMP2

MMP1

MMP3Y

MMP2Y

Code	Length	Head Diameter	Washer Fit	Unit Of Sale
MMP1	10cm	3cm	✓	1,000
MMP2	15cm	3cm	✓	Single
MMP2Y	15cm	3cm	✓	500
MMP3	19cm	4cm	✓	Single
MMP3Y	19cm	4cm	✓	500
MMP4	15cm	4.7cm	✓	500
MMP5	15cm	3cm	x	500
WASHER		5cm diameter		500

Cross Bar Tree Ties

The tie is fastened onto the cross bar with wood screws and washers and then it wraps round the tree using the adjustable tie.

It is made from a black UV stabilised soft rubber plastic which protects and holds the tree firmly. The tie can be adjusted as the tree is growing if required. These ties suit small to medium trees.

- A one piece, soft material tie to protect the bark of the tree
- Fast to fit, light to carry
- More economical to buy and use than traditional strapping and block.



Code	Tree Size	Pack Size
TP330	For trees 1 - 2 inches in diameter	50
TP590	For trees 2 - 3 inches in diameter	50

Super Soft Tree Ties

Made from a black soft rubber plastic, with moulded grooves to prevent damage to the bark of the trees, these tree ties are lighter to carry and faster to fit than conventional ties. The tie itself acts as a cushion between the tree and the support stake, thus obviating the use of a separate spacer. They are weather resistant and treated with U.V. stabilisers so they do not stiffen or split with age. Because of the elasticity of the material the tree will not be disfigured as the tie stretches.



Code	Length	Width	Pack Size
TP30	30cm (12")	12mm	100
TP35	35cm (14")	16mm	100
TP40	40cm (15")	22mm	100
TP45	45cm (18")	22mm	100
TP60	60cm (23")	22mm	100

Tree Care

Buckle Tree Ties			
Made from soft black PVC, they will stretch as the tree grows and are easily adjustable. They are supplied with a hoop collar and spacer.			
Code	Length	Width	Pack Size
TIE/15	30cm (12")	13cm (1/2")	100
TIE/12	40cm (15")	25mm (1")	100
TIE/02	45cm (18")	25mm (1")	100
TIE/03	60cm (24")	25mm (1")	100

Chainlock				
Chainlock is a quick and easy way of supporting a tree to a stake or post. You simply wrap it around the tree and the support and then lock it in place by threading it through itself.				
Code	Reference	Width	Thickness	Coil Length
CHAIN/14	C217 (No2)	11.4mm	2.5mm	25m
CHAIN/11	C219 (No4)	25.4mm	2.5mm	25m
CHAIN/06	C220 (No5)	25.4mm	3.8mm	25m

Tree Support Ties

The tree support tie is designed to support and protect the tree when grown against steel, nylon wire and anti slip cord. The tie acts as a cushion by the nature of the soft synthetic rubber material and design.

For the TST300, 400 and 600 lift upwards the hinged centre block, position the support wire underneath and into the two grooves either side.

Bring the two straps round the tree and tighten each one, so the whole tie self grips. When the tie is tightened it grips and does not slip along the wire or cord.

For the TST200 just wind it onto wire and tie onto tree.

The tree is held firmly and it does not suffer any damage to the bark. The tie is soft, strong, black and UV protected.

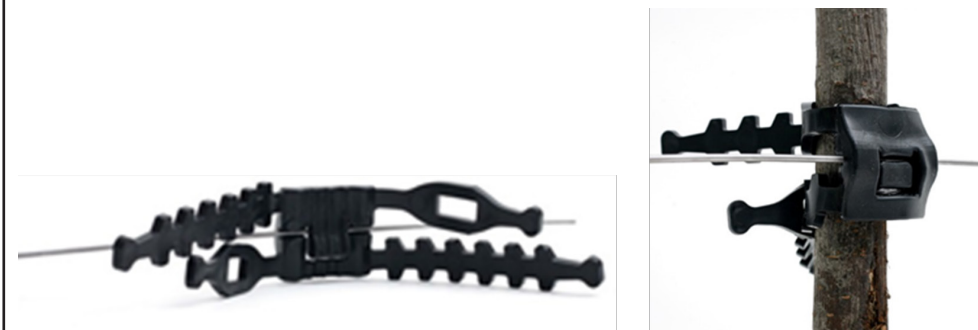

Code	Dimensions	Pack Size
TST200	Small bushy trees approximately 3cm diam, 3/4mm wire/cord	100
TST300	For small container trees approximately 5cm diam, 3/4mm wire/cord	50
TST400	For medium trees approximately 7.5cm diam, 3/4mm wire/cord	50
TST600	For large trees approximately 10cm diam, 6/8mm wire	50

Tree Tying

Soft Strapping, Cushions and Hoop Collars

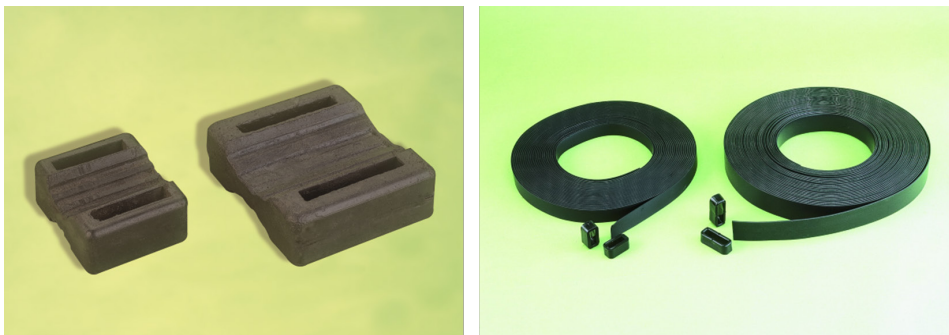

Code	Description	Strapping Size	Length	Pack Size
ST25	Soft Strapping	25mm (1")	25m	1 coil
HDST25	Heavy duty strapping	25mm (1")	25m	1 coil
TC25	Soft Cushions	25mm (1")		100
HC25	Hoop Collars	25mm (1")		100
ST38	Soft Strapping	38mm (1½")	25m	1 coil
HDST38	Heavy duty strapping	38mm (1½")	25m	1 coil
TC38	Soft Cushions	38mm (1½")		100
HC38	Hoop Collars	38mm (1½")		100

Super Soft Adjustable Shrub Ties

The Super Soft shrub ties stretch as the shrub or plant grows. They are extremely strong, U.V. stabilised, easily adjusted and are reusable.



Code	Length	Pack Size
TP13	130mm (5")	500
TP17	170mm (7")	250
TP31	310mm (12")	100

Adjustable Ties for Shrubs & Trees

TP125, TP175, TP225, TP430

A single tie for light tying of climbers, shrubs and small trees. Made from green polyethylene material it is very strong and long lasting.

TP320:

A double tree tie for light applications of tying trees to a support stake, made in green polyethylene material, very strong, durable and will last many seasons outdoors.

TP180:

The same as the TP320 but shorter. Made from strong black polyethylene material which in turn makes it long lasting.

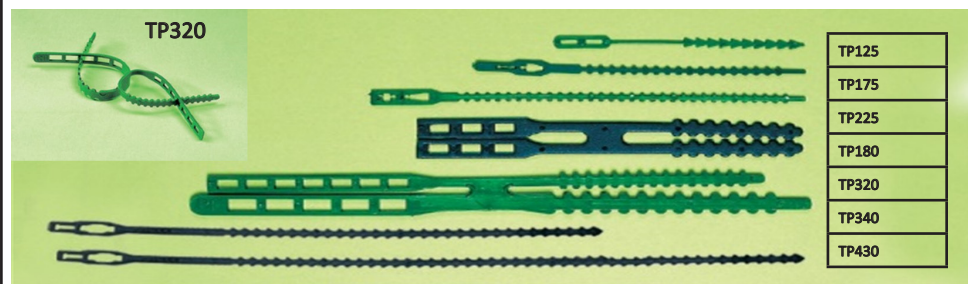

Code	Length	Pack Size
TP125	125mm (5")	500
TP175	175mm (7")	500
TP225	225mm (9")	500
TP340	340mm (13.5")	500
TP430	430mm (17")	500
TP180	200mm (8")	500
TP320	320mm (12.5")	250

Square & Rounded Tree Stakes

Treated & Pointed Square & Machine Rounded Tree Stakes/ Posts

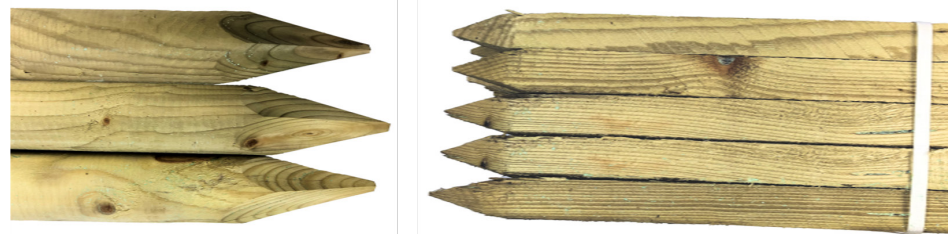

Treated for longevity and pointed at one end. Ideal for trees and shelters. Available as singles or by the pallet.

Code	Length	Shape	Size	Pallet Quantity	Pack Quantity
STAKE-SQ/01	75cm	Square	25mm x 25mm	2400	25
STAKE-SQ/03	90cm	Square	25mm x 25mm	1200	25
STAKE-SQ/05	1.2m	Square	32mm x 32mm	840	10
STAKE-SQ/07	1.35m	Square	32mm x 32mm	840	Single
STAKE-SQ/08	1.5m	Square	32mm x 32mm	840	10
STAKE-RD/01	1.2m	Round	50mm	431	Single
STAKE-RD/02	1.5m	Round	50mm	431	Single
STAKE-RD/04	1.65m	Round	50mm	431	Single
STAKE-RD/06	1.65m	Round	75mm	203	Single
STAKE-RD/07	1.8m	Round	50mm	431	Single
STAKE-RD/09	1.8m	Round	75mm	203	Single
STAKE-RD/10.5	2.1m	Round	50mm	431	Single
STAKE-RD/10	2.1m	Round	60mm	298	Single
STAKE-RD/11	2.4m	Round	50mm	431	Single
STAKE-RD/13	2.4m	Round	75mm	203	Single

Tree Shelters

Fortetub Tree Shelters

The Fortetub range of tree shelters are now a firmly established go to product within leading forestry organisations in the UK.

This twin walled range of shelters comes in three sizes - 60cm, 75cm and 120cm. With long, adjustable cable ties, a weak splitting point down the side of the tube and a flared rim at the top, these shelters are excellent for protecting trees in their early years of life. For use in Forestry, Landscaping and Agricultural planting projects. The shelters come to you delivered in bags so carrying them to site is easy.

-Available at no extra cost with micro holes for greater aeration (subject to availability).



Code	Colour	Height	Diameter	Nest	Pack Quantity	Unit Of Sale
FORTE/03	Green	0.6m	75mm - 100mm	5	250	Each
FORTE/05	Green	0.75m	75mm - 100mm	5	250	Each
FORTE/01	Green	1.2m	75mm - 100mm	4	140	Each

Tubex Standard Shrub Shelter

The Tubex Standard Shrub Shelter offers a twin walled design with 1 adjustable cable tie offering protection against rabbits and voles.

Measuring 60cm high and with a diameter of 130mm-160mm the twin walled design, with one adjustable cable tie, provides protection against rabbits and voles at this height. This product is easy to install and remove.



Code	Colour	Height	Diameter	Nest	Pack Quantity
TUBEX/04	Green	0.6m	130mm - 160mm	4	28

Tubex Easywrap

The Tubex Easywrap is a twin walled tree guard with vertical split which produces a natural overlap. It offers flexibility and a cost effective solution for your tree guard requirements.

- Cost effective alternative to spiral tree guards
- Support with bamboo cane

Code	Colour	Height	Diameter	Nest Qty	Pack Quantity
TUBEX/03	Green	0.6m	50 - 65mm	2	150



Tree Care

Defender Pro

The Defender Pro tree shelter not only offers faster tree growth and increased survival rates but it is also able to reduce the cost of planting maintenance.

The square construction of the Defender Pro enables it to be delivered to the point of application ' flat pack ' thus enabling larger quantities to be transported easier and at a lower cost than the conventional round rigid tree shelter.

The unique staking and securing system ensures planting is completed simply and swiftly whilst maintenance can be carried out with the same level of simplicity and speed.

Manufactured from environmentally responsible and 100% recyclable UV stabilised polypropylene, the Defender Pro has a built-in radial top lip to minimise abrasion to the tree stem and a line of least resistance to ensure the shelter splits open as the girth of the tree increases in size.



Code	Reference	Height	Colour	Diameter	Pack Quantity
DEFE/04	C724GN	60cm	Green	10cm	50
DEFE/05	C725GN	75cm	Green	10cm	50
DEFE/03	C727GN	1.2m	Green	10cm	50
DEFE/01	C738GN	60cm	Green	15cm	50

Spiral Tree Guards

Tree Spirals are a low cost protection for young trees such as standards, seedling transplants and single stem hedge plant varieties, against browsing animals such as rabbit, hare, sheep and roe deer. They are extremely quick and easy to install and in most cases do not need additional tree stakes or fastenings to support them.

A major benefit in using the Tree Spiral is their ability to grow with the trees as they mature. Its overlap design avoids the risk of strangulation of the tree and also offers protection against the use of chemicals. Our experience shows that young trees develop better with ventilation holes, as this reduces the effects of mildew and leaf burn both of which will stunt growth but if using chemicals then a no holes option should be used.



Code	Colour	Height	Diameter	Pack Quantity
STG45C-R	Clear	45cm (18")	38mm	250
STG45B-R	Brown	45cm (18")	38mm	250
STG60C	Clear	60cm (24")	38mm	250
STG60B	Brown	60cm (24")	38mm	250

Tree Care

Tree Protection

Tree Protectors

Manufactured to a high standard these Tree Protectors from Rainbow are the ideal solution to protect semi mature trees from harmful damage.

Offering increased protection and durability. Once the tree has matured the protector is no longer required and can easily be removed and re-used. Suitable for use with or without grill.



Code	Product	Colour	Height	Diameter	Pack Size
TREE-PROT-CLAS	Classic Range	Black	1.8m	40cm & 60cm	Each
TREE-PROT-RTD	Roll Top Deco	Black	1.8m	40cm & 60cm	Each
TREE-PROT-PST	Premier Straight Top	Black	1.8m	40cm & 60cm	Each

Code	Description	Reference	Dimension	Hole Size	Pack Size
GRILL/01	City Tree Grill	C759	80cm x 80cm	40cm	Each
GRILL/02	City Tree Grill	C760	100cm x 100cm	50cm	Each
GRILL/03	City Tree Grill	C761	120cm x 120cm	50cm	Each

Wire Mesh

Weldmesh Tree Guards

For instant protection, galvanised tree guards can be placed around the tree and then staked into position.

Made from a heavy duty galvanised mesh, these tree guards provide long term protection.



Code	Height	Diameter	Mesh Size	Pack Size
TREEGUARD/11	1.8m	300mm	4" x 1"	Each

Galvanised Wire Rabbit Netting

The wire netting is recommended for use in small animal enclosures. The mesh is comprised of twisted wires in a hexagonal shape.



Code	Height	Mesh Size	Roll Length	Pack Size
WIRE-NET/01	1000mm	31mm	50m	Each

Stock Fencing C8/80/15

The most popular fence for sheep, pigs or general fencing.

Code	Height	Mesh Size	Roll Length	Pack Size
WIRE-SF-50/01	800mm	10cm x 10cm	50m	Each
WIRE-SF-100/01	800mm	10cm x 10cm	100m	Each



Rootzone Watering Systems

Hunter Rootzone Watering Systems

For young plants and trees to thrive, they must receive adequate irrigation and a steady exchange of oxygen across all levels of the root zone. This encourages roots to grow deep and remain safely below ground, allowing plants to become strong and fully established. Developed to meet this challenge, the Root Zone Watering System features Hunter's patented StrataRoot™ design, a series of internal baffles that direct water, oxygen and nutrients to the root zone and provide rigidity to the irrigation cylinder for added durability. The RZWS comes pre-assembled for easy installation, and the enclosed design and grate protect irrigation hardware from vandalism. For efficient irrigation of trees and shrubs delivered throughout the root zone, the Hunter RZWS is the optimal solution.



Code	Diameter	Cap Diameter	Length	Quantity
RZWS-10	5.1cm	12cm	25cm	Each
RZWS-18	7.6cm	12cm	45cm	Each
RZWS-36	7.6cm	12cm	90cm	Each

RootRain Urban

The RootRain Urban is a large capacity irrigation system with fixed grid inlet, particularly suited to open space and roadside verge tree planting in softscape.

The grid allows water and air through but prevents ingress of litter and debris. The inlets are trimmer resistant and can be set below mowing machine height. They have very little vandal appeal and no theft value, making them ideal for housing estates and public areas.

- Large capacity 60mm watering circuit
- Easy and quick installation
- Cost-effective on large and small schemes
- Extremely vandal resistant
- Discreet and unobtrusive appearance



Code	Length	Diameter	Inlet	Weight
RRURB1A	3m (10ft)	60mm (2.5")	80mm (3")	1kg
RRURB2A	5m (16.5ft)	60mm (2.5")	80mm (3")	1.4kg
RRURB3A	8m (26ft)	60mm (2.5")	80mm (3")	2kg

Lawn Edging

Rite Edge

Rite-Edge is a high quality and durable solution for lawn edging, garden edging, landscape edging and more.

- Suitable for edging lawns, borders, beds & pathways
- Makes perfect straights, corners & enviable curves & shapes
- Permanent installation - No maintenance required
- Unique design makes installation quick & easy
- Saves hours of edging work
- Comes complete with fixing stakes



Code	Reference	Colour	Width	Length	Pack Qty	Pack Length
RITE/02	C531	Natural Aluminium	10.2cm	2.4m	14	33.6m
RITE/02RT	C531RT	Natural Aluminium	10.2cm	2.4m	4	4.8m
RITE/01	C532	Brown Aluminium	10.2cm	2.4m	14	33.6m
RITE/01RT	C532RT	Brown Aluminium	10.2cm	2.4m	4	4.8m
RITE/09	C533	Green Aluminium	10.2cm	2.4m	14	33.6m
RITE/05	C534	Black Aluminium	10.2cm	2.4m	14	4.8m

Ground Protection

Rite Pavé

Rite-Pavé reinforcement systems are designed for long term use, providing a porous substrate support system which holds earth, grass or gravel.

Any area of ground subject to pedestrian, animal or vehicular traffic is subject to erosion of some description, prevention of which requires some sort of surface reinforcement. Traditionally, this has been done using concrete, tarmac or block paving. Traditional solutions are not environmentally friendly and contribute to the growing problem of urban hotspots which cause concern to the ozone layer and carry the necessity for the implementation of extra drainage systems. These problems apply not just to traffic areas but parking areas, temporary access routes and roof tops, all of which are contributing to rising temperatures and increasing flood risk zones. The solution to all these problems is to use a porous surface which will retain water for gradual release and will absorb heat much more and reduce the hot spots now seen to be so damaging to the environment. Another benefit of using porous surfaces is that they can greatly enhance the appearance of any area, particularly when filled with decorative stone or plant growing medium for grass or sedum.

Rite-Pavé is designed to easily join together to form a structure that can handle thermal expansion within itself. The design is also perfect for supporting healthy grass growth within the cell which keeps the finished installation looking good.

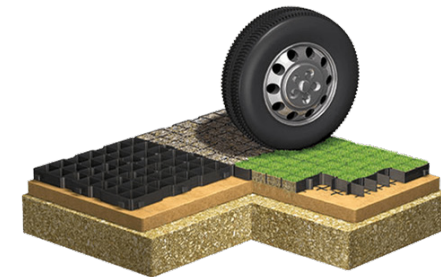

Code	Reference	Description	Unit Of Sale	Pallet Qty
RITE/03	C529BK	Rite Pavé Black	1m2	58m2
RITE/04	C529GN	Rite Pavé Green	1m2	58m2
RITE-MARK	C526	Yellow or White marker	Each	

Landscaping

Powergrid Heavy Duty Turf Reinforcement

Powergrid is an extra heavy duty reinforcement mesh. Suitable for protecting high traffic grassed areas. It can be used to create an overflow car park or vehicle access routes, as well as protecting grassed entrances / exits or other areas of high wear.

The mesh has a unique anti-slip curved structure for extra protection when used in wet conditions. Powergrid comes in two roll sizes as standard: 1m x 10m and 2m x 20m, in green and in two weights. Easily installed by simply rolling it out and securing to the ground with steel u-pins.



Code	Product	Width	Length	Mesh Diameter
TF1005	Powergrid 11 - Standard	2m	20m	11mm
TF1006	Powergrid 11 - Standard	1m	10m	11mm
TF1003	Powergrid 15 - Premium	2m	20m	15mm
TF1007	Powergrid 15 - Premium	1m	10m	15mm

Standard Turf Reinforcement Mesh

This standard turf reinforcement mesh is designed to protect heavily used grass areas, including temporary or overflow parking, or for vehicle traffic to prevent turf damage. It can also be laid and removed during events, as well as being suitable for long term protection



Code	Width	Length
TF1001	2m	25m

Geoweb

A 3 dimensional cellular confinement system manufactured from high-quality, high-strength polyethylene. When the cells are filled they control shearing, lateral and vertical movement. This allows the use of less costly on-site infill materials and reduces base material requirements and costs by half. We recommend a geotextile under the GeoWeb for load support and can offer all fittings to make for an easier installation.

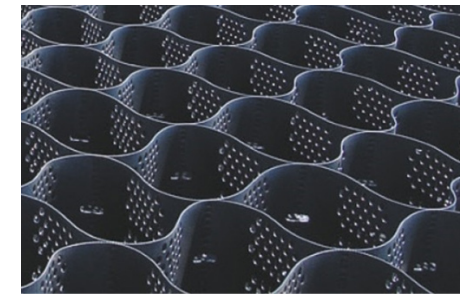

Code	Dimensions	Depth
GEO07501	2.6m x 8.3m	75mm
GEO10001	2.6m x 8.3m	100mm
GEO15001	2.6m x 8.3m	150mm
GEO20001	2.6m x 8.3m	200mm

Vegetated Walls

Flex MSE Bag

Flex MSE is a patented engineered solution for vegetated retaining walls and erosion control. Flex MSE bags and interlocking Plates are used to build naturally resilient geomodular structures.

A unique soft building material which exhibits hard material qualities, Flex MSE adapts to events that would ruin lesser systems, and only gets stronger and greener as time goes on. Flex MSE is a patented system which leverages Mechanically Stabilised Earth (MSE) principles along with geotextile technology to create strong and easy to install Geomodular block structures.

• Flex MSE Bags Are:

- Filled with sand and organics
- An ideal 'planter block' for many types of vegetation
- Water and root permeable
- Flexible enough to create almost any contour or angle
- Suitable for hydro-seeding



Code	Type	Width	Length	Filled Height
FLEX-MSE/01	Unfilled bag + plate	380mm	890mm	-
FLEX-MSE/02	Filled bag + plate	300mm	760mm	140mm

Flex MSE Interlocking Plate

Flex MSE bags and interlocking plates are used to build naturally resilient geomodular structures.

Flex Plates Bags Are:

- Made from 100% recycled material
- Designed to bridge the gap between bags to create an interlocking mechanical connection
- Engineered with friction strips for greater bag to bag mechanical connection and geogrid hooks to connect to soil reinforcement



Height	Length	Width	Spikes	Hooks	Weight
42mm	385mm	99mm	11	2	63g



Landscaping

Grass Seed

The All Rounder

A great multi-purpose, everyday grass seed that will deliver a lawned area for rough and tumble of everyday use while giving a quality and attractive appearance.

SUITABLE AREAS:

- All landscaping
- Quality lawns
- Everyday lawns
- Parks, housing, industrial
- Embankments
- Caravan parks
- Heavy traffic



Code	Pack Size	Sowing Rate	Other pack sizes
SEED-GREEN	20kg	25-30g/m ²	525kg (15m ²) 1.75kg (50m ²) 10kg

Mow Saver

A unique grass mixture that establishes fast AND requires less mowing. Thanks to rapidly-germinating properties of the varieties selected in this mixture, fast establishment of a new lawn is possible.

- Fast establishment
- Saves time and money
- Use all round the garden



Code	Pack Size	Sowing Rate	Other pack sizes
SEED-GREEN-MS	20kg	25-30g/m ²	525kg (15m ²) 1.75kg (50m ²) 10kg

The Shady One

A high quality grass seed mixture that is specifically formulated to create an excellent lawn in shady places.

- Shade tolerant grass seed
- Ideal for areas under full or partial shade
- Designed to perform under tree canopies
- Improved tolerance to common diseases
- Good tolerance to drought



Code	Pack Size	Sowing Rate	Other pack sizes
SEED-GREEN-SO	20kg	25-35g/m ²	525kg (15m ²) 1.75kg (50m ²) 10kg

The Perfectionist

A fine and luxury traditional grass seed mixture delivering a superior, quality result for a lawn with a wow factor.

- Non-ryegrass, fescue blend for exceptional quality
- Luxurious, quality look for areas with lower levels of traffic
- A very fine leaved and dense lawn
- High quality and beautiful looking lawn
- Improved tolerance to common diseases



Code	Pack Size	Sowing Rate	Other pack sizes
SEED-GREEN-MS	20kg	25-35g/m ²	525kg (15m ²) 1.75kg (50m ²) 10kg

Landscaping

Grass Seed

The Action Hero

A hard wearing grass seed mixture that contains tough wearing grasses which is ideal for playing areas with high traffic.

- All landscaping
- Everyday lawns
- Parks, housing, industrial
- Playing fields
- Heavy traffic



Code	Pack Size	Sowing Rate	Other pack sizes
SEED-GREEN-TAH	20kg	30-40g/m ²	525kg (15m ²) 1.75kg (50m ²) 10kg

Equine | General Purpose

Hardwearing general-purpose mixture designed to withstand the pressures of equestrian use and provide good quality grazing for horses.

- Specially selected varieties for roughage and low fructan content
- Produces a good, spring, dense turf
- Reduced fructan the risk of laminitis
- Strong grass plant rooting system, making the sward dense
- Paddock will deliver grazing and forage production
- Yields good levels of effective roughage



Code	Pack Size	Sows	Repairs
SEED-EQUINE-GP	10kg	Up to 0.7acre	1 acre

The Easy Fixer

A revolutionary, one-step Quick Patch Repair Kit combining grass seed with coir compost and naturally occurring fertiliser.

SUITABLE AREAS

- * All landscaping



Code	Pack Size	Area Treated
SEED-GREEN-TEF	1kg	15 patches of around 50cm in diameter

Equine | Traditional Meadow

Formulated to recreate the nutritional characteristics of a natural habitat, The mixture is ryegrass free and uses species with a less aggressive growth habit to aid diversity.

- Lower in fructan than a ryegrass mix
- The healthiest pasture for your horse
- Helps prevent laminitis
- Effective fibre in your horse grass
- The optimum grass seed for your horse meadow
- Good horse pasture that can be effectively managed



Code	Pack Size	Sows	Repairs
SEED-EQUINE-TM	10kg	Up to 0.7acre	1 acre

Landscaping

Wildflowers			
A range of essential wildflowers for all habitats. This range will transform dull areas into colourful wildlife friendly areas. All mixtures are available as either a 80/20 wildflower/seed mix or as a 100% wildflower mixture.			
Code	Habitat	80/20 Pack Sizes	100% Pack Sizes
SEED-WF-AS	Acidic Soils	0.5kg & 1kg	0.35kg, 0.5kg & 1kg
SEED-WF-BB	Bees & Butterflies	0.5kg & 1kg	0.35kg, 0.5kg & 1kg
SEED-WF-CLC	Chalk, Limestone, Calcareous	0.5kg & 1kg	0.35kg, 0.5kg & 1kg
SEED-WF-CAM	Classic Annual Mix	0.5kg & 1kg	0.35kg, 0.5kg & 1kg
SEED-WF-CHS	Clay / Heavy Soils	0.5kg & 1kg	0.35kg, 0.5kg & 1kg
SEED-WF-C	Coastal	0.5kg & 1kg	0.35kg, 0.5kg & 1kg
SEED-WF-CA	Cornfield Annual	0.5kg & 1kg	0.35kg, 0.5kg & 1kg
SEED-WF-DSS	Dry, Sandy Soils	0.5kg & 1kg	0.35kg, 0.5kg & 1kg
SEED-WF-CHM	General Purpose, Classic Hay Meadow	0.5kg & 1kg	0.35kg, 0.5kg & 1kg
SEED-WF-G	Groundcover (low growing)	0.5kg & 1kg	0.35kg, 0.5kg & 1kg
SEED-WF-SHWE	Shaded Hedgerow & Woodland Edge	0.5kg & 1kg	0.35kg, 0.5kg & 1kg
SEED-WF-LVS	Loam / Variable Soils	0.5kg & 1kg	0.35kg, 0.5kg & 1kg
SEED-WF-PS	Pastel Shades	0.5kg & 1kg	0.35kg, 0.5kg & 1kg
SEED-WF-RWB	Red, White, Blue	0.5kg & 1kg	0.35kg, 0.5kg & 1kg
SEED-WF-SF	Short Flowers	0.5kg & 1kg	0.35kg, 0.5kg & 1kg
SEED-WF-TF	Tall Flowers	0.5kg & 1kg	0.35kg, 0.5kg & 1kg
SEED-WF-UW	Universal Wildflowers	0.5kg & 1kg	0.35kg, 0.5kg & 1kg
SEED-WF-WWE	Wetland & Water Edge	0.5kg & 1kg	0.35kg, 0.5kg & 1kg

Multi Sport

An outstanding sport mixture for renovating and constructing pitches and sports pitches. Multi sport is a 100% UK-produced grass seed that offers exceptional colour with reduced nitrogen requirements.

- 100% perennial ryegrass
- Suitable for Football, Rugby and multi use sports fields
- Suitable for renovating or constructing sports fields
- Multiple usage at variable sowing rates



Code	Pack Size	Sowing Rate	Over Sowing Rate
SEED-BAR-MULTI	10kg	30-50g/m ²	15-30g/m ²

Medal

Designed for the construction or overseeding of medium-fine and fine turf with high wear pressure. Medal is suitable for use on bowling greens, golf greens, fairways, golf tees and ornamental lawns.

- Fine appearance with excellent wear characteristics
- Top varieties offer greater performance
- Excellent shoot density
- Greater disease tolerance



Code	Pack Size	Sowing Rate	Over Sowing Rate
SEED-BAR-MULTI	10kg	30-50g/m ²	15-30g/m ²

Decorative Aggregates

Cobbles

<p>Scottish Cobble & Pebbles</p> <p>From large Scottish Boulders through to small pebbles, whether it be a pathway or water feature, we are sure to have the material to bring your garden to life.</p> <p>These products are all fish friendly.</p> <p>End each code with the packaging unit reference below to depict the packaging size you require.</p> <p>HB: 25kg Handy Bag BB: 850kg Bulk Bag LL: Loose Load</p>			
	<p>Scottish Boulders 200-300mm</p> <p>Code: BOULDER-</p>	<p>Scottish Cobbles 120-200mm</p> <p>Code: COBBLE-120-</p>	<p>Scottish Cobbles 30-50mm</p> <p>Code: COBBLE-30-</p>
			
<p>Scottish Cobbles 50-80mm</p> <p>Code: COBBLE-50-</p>	<p>Scottish Cobbles 80-120mm</p> <p>Code: COBBLE-80-</p>	<p>Scottish Pebbles 14-20mm</p> <p>Code: PEBBLE-14-</p>	<p>Scottish Pebbles 20-30mm</p> <p>Code: PEBBLE-20-</p>

Decorative Aggregates

Slate

Slate Chippings				
<p>As with all slate, the colours become more vibrant when wet so adding to the look of your garden all year round.</p> <p>These products are all fish friendly.</p> <p>End each code with the packaging unit reference below to depict the packaging size you require.</p> <p>HB: 25kg Handy Bag BB: 850kg Bulk Bag LL: Loose Load</p>				
	<p>Blue Slate 20mm Code: SLATE-BL-20-</p>	<p>Blue Slate 40mm Code: SLATE-BL-40-</p>	<p>Green Slate 40mm Code: SLATE-GR-40-</p>	
				
<p>Grey Slate 40mm Code: SLATE-GR-40-</p>	<p>Plum Slate 20mm Code: SLATE-PL-20-</p>	<p>Plum Slate 40mm Code: SLATE-PL-40-</p>		

Decorative Aggregates

Gravels & Chippings

<p>Using gravels and chippings in the garden is a great way of adding texture and colour without the need for ongoing maintenance. We offer a great selection of decorative gravels and chippings, our range features a variety of colours, textures and sizes so you can find the ideal one to compliment your garden.</p> <p>End each code with the packaging unit reference below to depict the packaging size you require.</p> <p>HB: 25kg Handy Bag BB: 850kg Bulk Bag LL: Loose Load</p>			
	<p>Black Ice 20mm</p>	<p>Black Basalt 10mm & 20mm</p>	<p>Blossom 20mm</p>
	<p>Code: GRAVEL-BI-20-</p>	<p>Codes: GRAVEL-BB-10- GRAVEL-BB-20-</p>	<p>Code: GRAVEL-BLOS-20-</p>
			
<p>Canterbury Spar 3-8mm</p>	<p>Cheshire Pink 14mm</p>	<p>Cotswold Chippings 20mm</p>	<p>Dove Grey Limestone 10mm & 20mm</p>
<p>Code: GRAVEL-CS-</p>	<p>Code: GRAVEL-CP-14-</p>	<p>Code: GRAVEL-CC-20-</p>	<p>Codes: GRAVEL-DG-10- GRAVEL-DG-20</p>

Decorative Aggregates

			
Golden Gravel 10mm & 20mm Codes: GRAVEL-GG-10- GRAVEL-GG-20-	Gravel 20mm Code: GRAVEL-20-	Green Granite 14-20mm Code: GRANITE-GR-14-	Pink Granite 20mm Code: GRANITE-PINK-20-
			
Nordic Granite 20mm Code: GRANITE-NOR-20-	Polar White Chippings 8-11mm Code: GRAVEL--PW	Yorkshire Cream 10mm Code: GRAVEL-YC-10-	Yorkshire Cream 20mm Code: GRAVEL-YC-20-

Transport & Handling

Wheelbarrows

Ultimate - 108					
					
Code	Tray	Weight	Length	Width	Height
BARROW/05	120lt Galvanised	14kg	150cm	61cm	63cm

GO - (Green)					
					
Code	Tray	Weight	Length	Width	Height
BARROW/07	90lt Polypropylene	10.5kg	148	66cm	58cm

Original Galv - 4041					
					
Code	Tray	Weight	Length	Width	Height
BARROW/06	90lt Galvanised	13kg	150cm	67cm	58cm

Original - 1041					
					
Code	Tray	Weight	Length	Width	Height
BARROW/08	90lt Epoxy Powder Coated	13kg	150cm	67cm	58cm

Ranger - 4095



Code	Tray	Weight	Length	Width	Height
BARROW/07	230lt Galvanised	34kg	177cm	87cm	80cm

Colt Galv - 4092



Code	Tray	Weight	Length	Width	Height
BARROW/08	150lt Galvanised	27kg	167cm	77cm	80cm

Haemmerlin Spares



Spare parts available for all Haemmerlin wheelbarrows.
Included are spare wheels and trays

4 Wheeled Hose Trolley

Designed for nurseries, large gardens and sports grounds and to provide a water supply on construction sites. Easy to use reel with brake system to lock the wheels, puncture free wheels and ergonomic handle.



Code	Dimensions (cm)	To Fit Hose	Weight (kg)
REEL-4WHEEL	608mm x 550mm x 620mm	19mm (¾") x 110m	21.3

Transport & Handling

Sack Trucks

Heavy Duty Sack Truck	
High quality tubular steel frame with pneumatic tyres and hand grips on handles. Ideal for use in and around the warehouse, office, home and garden.	
Code	
85670	



Dolly Sack Truck > 85cm	
Heavy duty sack truck designed to move large planted pots on site. Board size 50 x 60cm.	
Code	Pot Capacity
TROL5	Up to 85cm Diameter



Dolly Sack Truck > 95cm	
Heavy duty sack truck designed to move large planted pots on site. Board size 60 x 70cm.	
Code	Pot Capacity
TROL6	Up to 95cm Diameter



Container Trolleys

Plant Container Trolley 55/57cm	
Strong, well made trolleys for movement of containers and heavy items safely and securely around the nursery . Will lift up to 90lt pot size.	
Code	Pot Capacity
TROL7	55-57cm



Plant Container Trolley < 50cm	
Strong, well made trolleys for movement of containers and heavy items safely and securely around the nursery .	
Code	Pot Capacity
TROL3	Up to 50cm



Plant Container Trolley < 70cm	
Strong, well made trolleys for movement of containers and heavy items safely and securely around the nursery .	
Code	Pot Capacity
TROL4	Up to 70cm



Transport & Handling

Danish Trolley Track

CC Trolley Track

The CC plates are the optimal solution for nurseries with frequent Danish trolley movements over rough ground. They have a wheel guide and can be inter-linked. With this system Danish trolley access becomes a whole lot easier.

- Very easy to lay
- Stable, weather-resistant and long lasting
- Sound dampening
- Effective Length: 1.2m

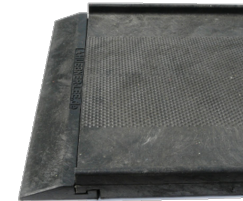

Code	Description	Size
TROL-TRACK	Danish Trolley Track	1.2m
TROL-RAMP	Danish Trolley Track Ramp (Bottom)	-
TROL-RAMP-B	Danish Trolley Track Ramp (Top)	-

Danish Trolley

Danish Trolley System



Product	Code
Danish Trolley Complete with 4 Posts and 3 Shelves	TROLLEY-COMP
Danish Trolley Base	TROLLEY-BASE
Danish Trolley Shelf	TROLLEY-SHELF
Danish Trolley Post	TROLLEY-POST
Danish Trolley Replacement wheel - Solid	TYRE15
Danish Trolley Replacement wheel - Swivel	TYRE16
Danish Trolley Liner	LINER11

Garden Centre Trolley

Ideal for manoeuvring around the garden centre and nursery. Suitable to carry plants, pots and accessories.

Main body is 94cm long x 65cm wide x 15cm deep, the top tray is 55cm x 18cm x 10cm.

Code

TROL9



Wippon Car

A simple yet effective way of moving a Danish trolley around the nursery. The Wippon car is clipped under the danish trolley to enable the pneumatic wheels to support the trolley and ride over uneven or rough ground with ease.

Code

WWT



Hand Tools

Secateurs

Felco Secateurs No.2 Original

Based on the original Felco design with top quality carbon steel blade which is easily replaceable as not riveted. Precision hardened and hollow ground with wire cutting notch. All in one forged alloy handle and anvil blade.

Code: SECATEUR/06



Secateurs No.7 Ergonomic Professional

One-hand, high performance, ergonomic pruning shear. The Felco No 7 comes with an easy, durable cutting adjustment, wire cutting notch and sap groove.

Code: SECATEUR/10



Felco Secateurs No.4 Standard

A more basic bypass pruner without the refinements but still with the famous Felco pruner quality and cutting performance. This model offers the same quality, extremely sharp cutting blade as the Felco 2.

Code: SECATEUR/07



Felco Secateurs No.8 Ergonomic

Light alloy handles are shaped to act as an extension of the forearm. The anvil blade handle is designed to prevent the pruner from sliding through the hand. Hollow-ground, the Swiss precision, hardened steel blade features a wire-cutting notch.

Code: SECATEUR/11



Felco Secateurs No.5 Standard

The lowest priced Felco pruner, recommended for basic garden maintenance. Pressed steel handles, tapered blades and easy cutting adjustment.

Code: SECATEUR/08



Felco Secateurs No.9 Ergonomic Left Handed

The Felco 9 bypass pruner is a left-handed pruner, it features light alloy handles which are shaped to act as an extension of the forearm. The anvil blade handle is designed to prevent the pruner from sliding through the hand.

Code: SECATEUR/12



Felco Secateurs No.6 Ergonomic

For the smaller hand. Handles have rubber shock absorber & cushion to protect the wrist. Toothed central nut for aligning the cutting & anvil blades easily and precisely for a clean, accurate cut.

Code: SECATEUR/09



Draper Basic Secateurs 45316

General purpose with one non-stick coated blade for smooth corrosion-free operation. Soft grip spring-loaded handles for user comfort and thumb lock for secure locking of the blades. Slider button for two jaw opening positions. Display packed.

Code: SECATEUR/16



Hand Tools

Professional Bypass Secateur

For use with thicker stems and 'live wood' in the garden such as mature roses, shrubs, and fruit bushes.

- Drop forged bypass blade
- Forged aluminium alloy handles
- Grip Lock
- Comfortable non slip grips
- Cutting Capacity 20mm



Code: SECATEUR/13 Supplier Reference: BD3152

Felco Replacement Volute Springs

Replacement springs for Felco secateurs.

Code	Reference	For Models	Unit Of Sale
SPRING/03	6/91	6,12	2
SPRING/02	2/91	2,4,7,8,9,10,11	2



Felco Holster No.910 Leather

Genuine leather holster with belt loop and clip (110g 235mm). Extremely well-made, with heavy-duty grain leather, waxed thread and extra riveting for long lasting use. For belt or pocket, high-tension metal clip on back. Also known as the F91.

Code: HOL5/03



Felco Replacement Blades

Replacement cutting blades for Felco secateurs.

Code	Reference	For Models	Unit Of Sale
BLADE/04	2/3	2,4,11	Each
BLADE/05	7/3	7.8	Each
BLADE/06	6/3	6,12	Each
BLADE/10	5/3	5	Each
BLADE/18	9/3	9,10	Each



Felco Holster No.912 Leather Cone

Genuine leather holster with belt clip (65g 150mm). Heavy-duty grain leather with waxed thread and extra riveting for long lasting use. This holster was specially designed to fit all Felco pruners and one-hand wire cutters. Can be used on belt or pocket with clip. Also known as the F93.

Code: HOL5/02



Felco Replacement Nut & Bolt Sets

Repair kits for all Felco secateurs. Repair kits contain centre bolt and nut, locking segment and screw for locking segment.

Code	Reference	For Models	Unit Of Sale
NUTB/01	7-90	7,8,9,10,13	Each
NUTB/02	6-90	6,11,12	Each
NUTB/03	2-90	2	Each



Hand Tools

Secateurs

Felco Sharpener 903 Diamond Coated
Multi-function sharpener made of diamond-coated hardened steel, essential for the sharpening, strengthening and honing of blade cutting edges to a professional standard. For pruning shears and cable cutters.
Code: SHARP/01



Felco Sharpener 902 Ceramic Stone
Sharpening tool comprises high quality corundum, with the choice of medium or fine grit abrasive surface. Easy to use, keeps its shape and is ideal for the sharpening of pruning shears and cable cutters.
Code: STONE/01



ARS 330H-R Handy Craft Scissors
These versatile scissors can be applied to a multitude of applications, from cutting plant stems and small plants to a range of handicraft applications such as cutting paper or plastic. This makes them an incredibly flexible choice for any toolbox.
Code: SCISSOR/01



ARS-300L Needle Nose Fruit Snip
The 300L is a Japanese manufactured fruit pruner which has become an instant industry favourite due to its lightweight design and extremely impressive cutting power.
Code: PRUNER/01



Knives and Folding Saws

Felco Knife Budding 39020
Grafting and budding knife with straight stainless blade, bevelled on one side, slightly curved at the end and with bark lifter on the back. Red nylon handle with standard alloy lining. Suitable for crown grafting, budding and whip and tongue grafting.
Code: KNIFE/03



Felco Knife All Purpose 39050
Grafting knife or cutting knife with straight stainless steel blade bevelled on one side. Red nylon handle with standard alloy lining. Suitable for crown grafting or propagating cuttings.
Code: KNIFE/04



Felco Knife Grafting/Pruning 39060
Grafting and pruning knife with stainless steel blade, bevelled on one side and very curved. Red nylon handle with standard alloy lining. Suitable for corner or whip and tongue grafting.
Code: KNIFE/05



Felco Folding Saw F600
There is nothing ordinary about the patented blade design of Felco saws. Unlike conventional saw teeth which are filed and alternately bent the turbo-cut saw blade is taper ground and each tooth is honed to precise knife-edge sharpness.
Code: SECATEUR/11



Hand Tools



Rakes

16P

A replica of the original hay rake only lighter, stronger and more flexible usage. Can be used for soil, gravel, grass & leaves. Comes with a back edge for accurate levelling and grading, particularly useful when preparing to lay new turf.



Code: RAKE/01

18A

Straight tooth and back edge blade. Made from highest quality aluminium, this is the most lightweight and robust aluminium rake on the market. This strong and versatile aluminium rake is designed for extensive use, particularly by groundsman responsible for preparing large flower beds and levelling extensive gravel pathways in parks and public/private gardens.



Code: RAKE/02

32P

This rake has curved teeth and a set of secondary teeth that run at 90 degrees from the top of the teeth, allowing easier collection and removal of wet leaves and grass.



Code: RAKE/04

18E

Also known as the "The Land Scraper" featuring an additional back edge/blade for grading and levelling.

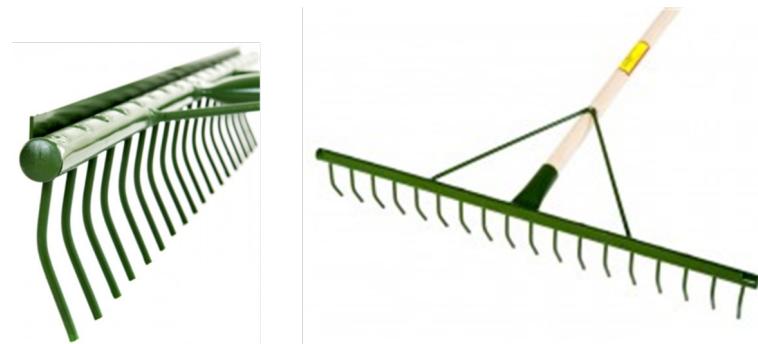

Code: RAKE/03

Hand Tools



Rakes

Wizard Rubber Rake

One of the most under stated garden tools on the market. The rubber tines on this rake allow leaves and debris to be collected from any surface without causing disruption. It will collect leaves from grass or a gravel drive. Great for picking up leaves from a wet patio.

- 54" Ash shaft
- Wide rubber head
- Will collect material from most surfaces
- 33 Soft rubber tines
- Replacement rubber available
- Head size 7" x 20" (177 x 510mm)



Code: 9149N



Garden Rake

A conventional style garden rake fitted with a light weight aluminium handle.

- 54" Aluminium shaft
- Carbon steel blade
- Metal head



Code: 7106775480

Plastic Leaf Rake

An entry level leaf rake for general garden duties. Strong plastic tines are cranked at the end for better collection of materials.

- Wide plastic head
- Head size 21" x 24" (535 x 610mm)
- Cranked tooth design
- Ash shaft
- 48" Ash handle



Code: BPR

Springbok Rake

Our most popular lawn rake. Used for scarifying lawns and removing unwanted growth. The tines are oil treated to give extra strength.

- 48" Ash shaft
- All steel head fabrication
- 20 Hardened steel tines
- Head size 14" x 19" (355 x 482mm)



Code: 9128N

Hand Tools



12 Tooth Garden Rake

A traditional style garden rake with strong steel teeth.

- 12 Tooth head
- 60" Ash handle
- Powder coated finish
- Head width 13" (330mm)

Code: 1121/12N



Hoes

Dutch Hoe (Aluminium)

A Dutch hoe head style, designed to cut weeds at the base. The carbon steel head is fitted to an aluminium handle to make the tool light weight.

- 54" Aluminium shaft
- Carbon steel blade, Head width 6" (150mm)

Code: 7107775480



14 Tooth Garden Rake

A traditional style garden rake with strong steel teeth.

- 14 Tooth head
- 60" Ash handle
- Powder coated finish
- Head width 14" (355mm)

Code: 1121/14N



Draw Hoe (Wood Handle)

The blade of this tool is quite square, it is ideal when used in a chopping motion.

- Carbon steel blade
- 54" Ash handle, Head width 6" (152mm)

Code: 1217N



Hay Rake (Wood Head)

Large spaced teeth help to collect the hay in economical qualities.

- 16 Tooth wooden head
- 70" Long straight handle
- Head width 27" (685mm)
- Handle length 70" (1575mm)

Code: 0247167080



Dutch Hoe 4"

Available with three sizes of blade from 4" to 6". This version is the smallest of the three sizes.

- 54" Ash shaft
- Carbon steel angled blade
- Powder coated finish
- Sharpened cutting edge
- Head width 4" (100mm)

Code: 3232/4N



Spades

Treaded Digging Spade	
<p>This traditional style spade is solid forged from one piece to give strength and durability in the garden. Available with wood "T" & "D", metal & plastic "D" grip. Ash handle used for strength & durability</p> <ul style="list-style-type: none"> • Handle length 28" (711mm) • Flat treaded blade • Solid Forged • Head size 11.5" x 7.5" (290 x 190mm) 	
	
Code	Handle Type
5610012820	Ash D
5610012810	T-Shaped
5610012850	Metal

Digging Spade (Soft Touch Handle)	
<p>This Evergreen version of our solid forged digging spade is fitted with a forward tilt ergo grip handle to help reduce stress when digging.</p> <ul style="list-style-type: none"> • Ash shaft • Soft touch grip with ergo design • Handle length 28" (711mm) • Solid Forged • Head size 11.5" x 8.5" (290 x 225mm) 	
	
Code	Handle Type
7101772890	Plastic D

Border Spade (Soft Touch Grip)	
<p>A traditional border spade but fitted with a modern forward tilt ergo grip handle to help reduce stress when digging.</p> <ul style="list-style-type: none"> • Ash shaft • Soft touch grip with ergo design • Handle length 28" (711mm) • Solid Forged • Head Size 9" x 5.5" (230 x 140mm) 	
	
Code	Handle Type
7102772890	Plastic D with ergo handle

Border Spade	
<p>Available with wood "T" or "D" grip.</p> <ul style="list-style-type: none"> • Ash handle used for strength & durability • Handle length 28" (711mm) • Solid Forged • Head size 9" x 5.5" (230 x 140mm) 	
	
Code	Handle Type
5609092820	Ash D
5609092810	T-Shaped

Hand Tools





Edging Knives

Edging Knife (Aluminium)	
<p>An edging knife with a half moon blade made from best quality carbon steel. The blade is fitted to an aluminium handle to make it light weight to use.</p> <ul style="list-style-type: none"> • 32" Aluminium shaft • Plastic "T" grip • Blade width 8" (204mm) 	
	
Code	Handle Type
7110773210	Plastic "T" grip

Forks

Digging Fork (Soft Touch Grip)	
<p>A traditional garden fork fitted with a modern forward tilt ergo grip handle to help reduce stress when digging.</p> <ul style="list-style-type: none"> • Ash shaft • Soft touch grip with ergo design • Handle length 28" (711mm) • Solid Forged • Head size 11.5" x 7.5" (290 x 190mm) 	
	
Code	Handle Type
7103772890	Plastic D with ergo handle

Solid Forged Edging Knife	
<p>We believe this is the only solid forged version of the half moon edging tool.</p> <ul style="list-style-type: none"> • Ash handle with "T" grip • Unique forged blade • Stronger than conventional edgers • Handle length 28" (711mm) • Solid Forged • Head width 8" (204mm) 	
	
Code	Handle Type
5680083210	Ash Handle with "T" grip

Border Fork (Standard)	
<p>This traditional style border fork is solid forged from one piece to give strength and durability around your borders and the garden.</p> <ul style="list-style-type: none"> • Ash shaft • Plastic "D" grip • Handle length 28" (711mm) • Solid Forged • Head size 9" x 5.5" (230 x 140mm) 	
	
Code	Handle Type
BBF	Plastic D

Hand Tools



Forks

Garden Fork	
<p>This traditional style fork is solid forged from one piece to give strength and durability in the garden. Available with wood "T" & "D", metal & plastic "D" grip.</p> <ul style="list-style-type: none"> • Ash handle used for strength & durability • Handle length 28" (711mm) • Four prong design • Solid Forged • Head size 11.5" x 7.5" (290 x 190mm) 	
	
Code	Handle Type
5704042820	Ash D
5704042810	T-Shaped
570404289D	Plastic D

Border Fork	
<p>This traditional style border fork is solid forged from one piece to give strength and durability in the garden. Available with wood "T" & "D", metal & plastic "D" grip.</p> <ul style="list-style-type: none"> • Ash handle used for strength & durability • Handle length 28" (711mm) • Solid Forged • Head size 9" x 5.5" (290 x 140mm) 	
	
Code	Handle Type
5715042820	Ash D
5715042810	T-Shaped

Bulb Planter

Solid Forged Bulb Planter	
<p>Solid forged, this bulb planter is ideal for larger bulb planting jobs. The shape of the blade allows a plug of soil to be extracted and replaced.</p> <ul style="list-style-type: none"> • Treaded blade • Ash handle with barrel "T" grip • Handle length 28" (711mm) • Plug tapered blade design • Head diameter 6" (152mm) 	
	
Code	Handle Type
5000002810	Ash Handle with Barrel "T" Grip

Shovels

Square Mouth Shovel # 2

Available with metal or plastic "D" or wood "T" grip.

Blade size no 2
Handle length 28" (711mm)
Solid Forged
Head size 12.5" x 10" (315 x 250mm)



Code	Handle Type
2SM2PD	Plastic D
2SM2T	T-Shaped

Taper Mouth Shovel (No.2)

Solid forged from one piece of steel to give maximum strength. The taper blade makes breaking into aggregate easier every time.

- Head size no 2
- All metal construction
- Handle length 28" (711mm)
- Metal "D" grip
- Solid Forged
- Head dimension 12.5" x 10" (315 x 250mm)



Code	Handle Type
5TM2AM	Metal D Grip

Aluminium Grain Shovel

Available with wood "T" & plastic "D" grip. The large deep dish design of this shovel allows you to move large volumes of at a time. Aluminium allows the spade to be cleaned thoroughly.

- Large aluminium blade
- Ash handle used for strength & durability
- Handle length 28" (711mm)
- Head dimension 12.5" (310mm)



Code	Handle Type
2007062890	Plastic D
2007062810	T-Shaped

Snow Shovel

Solid forged from one piece of steel to give maximum strength. The taper blade makes breaking into aggregate easier every time.

- Metal edging strip
- Heavy duty plastic ribbed head
- 42" Ash shaft with plastic "D" grip
- Also has equestrian uses
- Head dimension 14" x 18" (360 x 460mm)



Code	Handle Type
SNOW1	Plastic D Grip

Shears

Bypass Ratchet Lopping Shears

Extending handles on this model allow the user to reach high into trees and hedge rows.

- Bypass ratchet cutting action
- Extending handles
- Fixed locking positions
- Push button handle lock
- Soft touch grips
- 102mm Cutting capacity



Code: **BD3110TA**

Hedge Shears (Wavy Blade)

Fitted with an extra long pair of blued steel blades..

- Straight blades
- Adjustable blade tension
- Soft touch grip
- Handle bumpers
- Light weight design
- Blade length 9" (230mm)



Code: **BD2232Y2**

Compound Bypass Lopping Shears

The compound action on this lopper allows you to apply much greater pressure when cutting.

- Compound cutting action
- Bypass cutting action
- Aluminium handles
- Soft touch grips
- Blade capacity 1.5" (38mm)
- 38mm Cutting capacity



Code: **BD1113Y2**

Edging Shear

For their size these shears are very light to use. Their handle length make them comfortable to use. The blades are adjustable.

- Adjustable blade pressure
- Wavy blade to reduce clogging
- Tubular steel shafts
- Heat treated blades
- 32" Handle with rubber grip



Code: **B613W**

Pruners

Tree Pruner

Sold separately from the BD699B handle the design of this tree pruner allows you to both prune and cut at a length of 2.4 metres when used with the handle.

- Blued steel bypass cutting shears
- Support arm for head locator
- Two pulley action system
- Use in conjunction with BD699B handle
- DO NOT use near power cables or phone cables
- Removable saw blade included



Code: **BD811**

Pruning Saw

A simple curved blade saw with a replaceable blade.

- 80 Tooth stainless blade
- Replaceable blade (BD7931B)
- Soft touch grip
- Hole in blade for storage
- Blade length 300mm



Code: **BD793**

Telescopic Handle (Tree Pruner)

Sold as an accessory to the BD811 tree pruner. The aluminium pole extends up to 2.4 metres.

- Twist and lock action to secure the head
- Located on ball socket
- DO NOT use near power cables or phone cables
- Use in conjunction with BD811
- Extends from 1300 to 2400mm



Code: **BD699B**

Bowsaw

Designed with a knuckle guard and quick blade release. This bowsaw is supplied with both a dry and green wood blade.

- Finger guard
- Supplied with both Green & Dry Blade
- Tubular steel frame
- Locking device for blade
- Finger guard
- Available in 3 sizes



Code: **BOWSAW21 (21")**

Code: **BOWSAW24 (24")**

Code: **BOWSAW30 (30")**

Hand Tools

Premier Hand Trowel

The carbon steel blade and heavy duty tang combine to make this a tough tool for the job in hand.

- Carbon steel blade
- Heavy duty tang
- 6" Hardwood handle
- Deep dished blade design
- 3.25" (82mm) Wide blade



Code: 1031000680

Transplant Trowel

The carbon steel blade and heavy duty tang combine to make this a tough tool for the job in hand.

- Carbon steel blade
- Heavy duty tang
- 6" Hardwood handle
- Narrow deep dished blade design
- 2" (50mm) Wide blade



Code: 1032000680

Hand Fork

This hand tool is made with the best quality carbon steel. The heavy duty tang that is welded to the blade makes the tool incredibly durable. A soft touch handle is fitted for comfort when gardening.

- Soft grip handle
- Carbon steel blade
- Strong ferrule
- Blade width 3" (75mm)



Code: 7111770680

Premier Weed Fork (Wood)

The carbon steel blade and heavy duty tang combine to make this a tough tool for the job in hand.

- Carbon steel blade
- Heavy duty tang
- 6" Hardwood handle
- Three strong tines
- 4" (100mm) Wide blade



Code: 1041030680

Hand Trowel

This hand tool is made with the best quality carbon steel. The heavy duty tang that is welded to the blade makes the tool incredibly durable. A soft touch handle is fitted for comfort when gardening.

- Soft grip handle
- Carbon steel blade
- Strong ferrule
- Blade width 3" (75mm)



Code: 7112770680

Hand Tools

Kent & Stow Tools

Border Fork

Extended shank to reduce back strain with minimal soil adhesion for an easy to clean and excellent rust resistant fork.

- High-quality stainless steel prongs
- Shaft made from beautiful ash wood split to form a traditional YD handle
- Extended shank for improved strength
- Excellent rust resistance

- Length: 1040mm
- Head Size: 227 x 137mm



Code: 70100016

Border Spade

Extended shank to reduce back strain with minimal soil adhesion for an easy to clean and excellent rust resistant spade

- High- quality stainless steel head
- Handle made from beautiful ash wood split to form a traditional YD
- Extended shank for improved strength
- Larger tread edge for added digging comfort

- Length:1040mm
- Head Size: 225 x 140mm
- Blade thickness: 2.5mm



Code: 70100011

Digging Fork

Extended shank to reduce back strain with minimal soil adhesion for an easy to clean and excellent rust resistant fork

- High-quality stainless steel prongs
- Shaft made from beautiful ash wood split to form a traditional YD handle
- Extended shank for improved strength
- Excellent rust resistance

- Length: 1110mm
- Head Size: 300 x 170mm



Code: 70100006

Digging Spade

Extended shank to reduce back strain with minimal soil adhesion for an easy to clean and excellent rust resistant spade.

- High-quality stainless steel head
- Handle made from beautiful ash wood split to form a traditional YD
- Extended shank for improved strength
- Larger tread edge for added digging comfort

- Length: 1110mm
- Head Size: 290 x 177mm
- Blade thickness: 2.5mm



Code: 70100001

Hand Tools

Long Handled Scarifying Rake

Perfect for removing thatch and moss from the lawn.

- Hand crafted, traditional quality
- Handle made from Ash Wood, tapered for comfort
- 10 sharp high quality polished stainless steel tines
- Oscillating head allows the rake to glide over the lawn with ease
- Perfect height for easy working, eliminates the need for bending
- Excellent rust resistance

- Length: 1550mm



Code: 70100901

Stainless Steel Long Handled Draw Hoe

For heavy duty weeding and earthing up at the perfect height for easy working.

- High-quality stainless steel blade
- Handle made from beautiful ash wood tapered for comfort
- Delivers manoeuvrability and agility with the upright luxury of a long shafted tool

- Length: 1550mm
- Head Size: 150 x 85mm
- Blade thickness: 2.5mm



Code: 70100046

Stainless Steel Long Handled Dutch Hoe

Designed to cut through the roots of weeds just under the surface in an easy push or pull motion.

- High-quality stainless steel blade
- Handle made from beautiful ash wood tapered for comfort
- Delivers the manoeuvrability and agility with the upright luxury of a long shafted tool
- Perfect height for easy working, eliminates the need for bending, reducing back strain

- Length: 1600mm
- Head Size: 170 x 130mm
- Blade thickness: 2.5mm



Code: 70100051

Stainless Steel Hand Onion Hoe

Swan Neck Onion Hoe for weeding around your onions. Suitable for general cultivation needs.

- High-quality stainless steel head
- Handle made from beautiful ash wood contoured for perfect comfortable grip
- Bevelled edge making it ideal for de-weeding and tilling soil
- Ideal for use in vegetable patches and rockeries
- Used for weeding in borders or rockeries

Length: 335mm



Code: 70100106

Hand Tools

Long Handled Fork

For extra reach in beds and borders.

- High-quality stainless steel prongs
- Handle made from beautiful ash wood tapered for comfort
- Perfect height for easy working, eliminates the need for bending, reducing back strain
- Excellent rust resistance
- Minimum soil adhesion

- Length: 1255mm
- Head Size: 130 x 77mm



Code: 70100021

Long Handled Bulb Planter

For the easy creation of uniform planting holes for various sizes of bulbs without the need for bending.

- High quality stainless steel bulb planter
- Made from Ash Wood, T shaped for comfort
- Designed to enter the soil easily with minimal soil adhesion
- Tread edge for easy plantation into the ground
- Eliminates the need for bending when planting bulbs
- Complete with a 4 inch scale to aid planting depth
- 6cm diameter to accommodate all sizes of bulbs



Code: 70100144

Long Handled Trowel

For extra reach in beds and borders.

- High-quality stainless steel blade
- Handle made from beautiful ash wood tapered for comfort
- Perfect height for easy working, eliminates the need for bending, reducing back strain

- Length: 1245mm
- Head Size: 150 x 83mm
- Blade thickness: 2.5mm



Code: 70100026

Edging Iron

Unique serrated half moon Edging Iron to ensure a straight and easy cut.

- High-quality sharp and curved stainless steel blade
- Handle made from beautiful ash wood T grip handle for comfort
- Efficiently cuts through border edges without having soil adhere
- Excellent rust resistance
- Minimum soil adhesion

- Length: 990mm
- Head Size: 215 x 105mm



Code: 70100066

Capillary Matting

Lantor Capillary Matting

Latex bonded wool, has excellent durability, water absorption and retention. Lantor matting prevents weed whilst maintaining plant health.

To minimise growth of algae the matting can be easily cleaned by brushing lightly with a dilute solution of a commercial cleaning product such as Jeyes Fluid.



Code	Width	Product Type	Application	Nominal Weight	Thickness	Water Holding Capacity	Length
CAPI/30	60cm	Lantor 2H	Indoor	247g/m ²	4mm	3lt/m ²	50m
CAPI/02	91cm	Lantor 2H	Indoor	247g/m ²	4mm	3lt/m ²	50m
CAPI/01	122cm	Lantor 2H	Indoor	247g/m ²	4mm	3lt/m ²	50m
CAPI/23	142cm	Lantor 2H	Indoor	247g/m ²	4mm	3lt/m ²	50m
CAPI/03	183m	Lantor 2H	Indoor	247g/m ²	4mm	3lt/m ²	50m
CAPI/05	60cm	Lantor 4H	Outdoor / Indoor	464g/m ²	8.8mm	5lt/m ²	25m
CAPI/06	90cm	Lantor 4H	Outdoor / Indoor	464g/m ²	8.8mm	5lt/m ²	25m
CAPI/04	120m	Lantor 4H	Outdoor / Indoor	464g/m ²	8.8mm	5lt/m ²	25m
CAPI/31	150m	Lantor 4H	Outdoor / Indoor	464g/m ²	8.8mm	5lt/m ²	25m

Aquamat

Aquamat is a multi-layered capillary matting, water is held between each layer and efficiently moves throughout the entire surface of matting, as plants use water, it is replaced by water held in other areas of the mat. Aquamat will shrink when dry, expanding again when re-wet. Aquamat can be steam cleaned, and will not react to most brands of algicide.



Code	Width	Application	Nominal Weight	Thickness	Water Holding Capacity	Length
AQUA-MAT/04	30cm	Indoor	380-400g/m ²	4mm	3.2lt/m ²	50m
AQUA-MAT/05	50cm	Indoor	380-400g/m ²	4mm	3.2lt/m ²	50m
AQUA-MAT/06	60cm	Indoor	380-400g/m ²	4mm	3.2lt/m ²	50m
AQUA-MAT/07	70cm	Indoor	380-400g/m ²	4mm	3.2lt/m ²	50m
AQUA-MAT/01	100cm	Indoor	380-400g/m ²	4mm	3.2lt/m ²	50m
AQUA-MAT/02	120cm	Indoor	380-400g/m ²	4mm	3.2lt/m ²	50m
AQUA-MAT/03	140cm	Indoor	380-400g/m ²	4mm	3.2lt/m ²	50m

Netting & Fabrics

Vivaplus & Floraplus 3 Layer Capillary Matting

Specially developed for professional horticulture these mattings consist of a clear polythene base layer; a quality capillary mat middle layer and a hard wearing woven top layer; all bonded together to make a premium capillary mat. Floraplus is suited for protected growing. Vivaplus is ideal for outdoor areas where watering maybe less frequent or where higher water volumes are required.



Code	Width	Product Type	Nominal Weight	Water Holding Capacity	Length
CAPI/19	165cm	Floraplus	300g/m ²	1lt/m ²	50m
CAPI/20	180cm	Floraplus	300g/m ²	1lt/m ²	50m
CAPI/35	210cm	Floraplus	300g/m ²	1lt/m ²	50m
CAPI/17	100cm	Vivaplus	400g/m ²	3lt/m ²	50m
CAPI/33	120cm	Vivaplus	400g/m ²	3lt/m ²	50m
CAPI/34	200cm	Vivaplus	400g/m ²	3lt/m ²	50m

CapiMAT Economy Capillary Mat

Offering great value CapiMAT capillary matting is suitable for nurseries, retail outlets and garden centres. Its impressive 2.5lt/m² water holding capacity makes it a popular choice amongst growers and retailers. Ideally should be used with impermeable base layer and perforated film to layer. CapiMAT is made from recycled wool and acrylic.

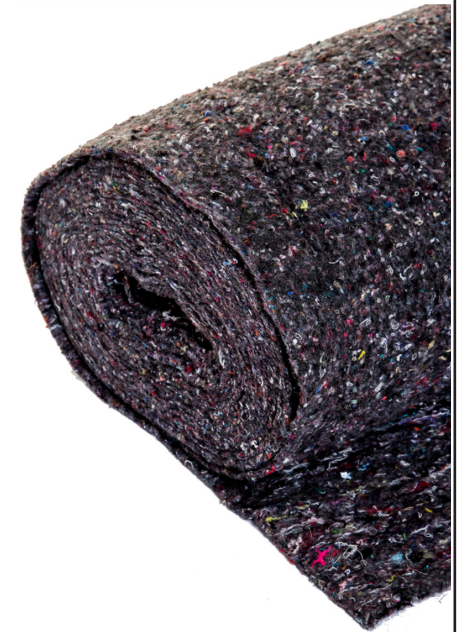

CapiMAT

Code	Width	Application	Nominal Weight	Thickness	Water Holding Capacity	Length
CAPI/18	100cm	Indoor	275g/m ²	3.5mm	2.5lt/m ²	50m
CAPI/22	120cm	Indoor	275g/m ²	3.5mm	2.5lt/m ²	50m
CAPI/24	150cm	Indoor	275g/m ²	3.5mm	2.5lt/m ²	50m
CAPI/25	180cm	Indoor	275g/m ²	3.5mm	2.5lt/m ²	50m
CAPI/28	200cm	Indoor	275g/m ²	3.5mm	2.5lt/m ²	50m



Frost Protection

Frost Protection Fleece

Frost protection fleece is a spun bonded polypropylene designed to offer crops protection from frost. By creating a microclimate the fleece encourages greater crop yields and earlier harvests.

Whether it be for Agriculture or Horticulture our crop protection fleece comes in many different weights and sizes to suit all your needs.

Code	Width	Length	Weight
FLEECE/01	1.5m	250m	18g/m2
FLEECE/03	2m	250m	18g/m2
FLEECE/04	2m	100m	18g/m2
FLEECE/20	3.2m	250m	18g/m2
FLEECE/07	4m	250m	18g/m2
FLEECE/09	5m	250m	18g/m2
FLEECE/23	6m	250m	18g/m2
FLEECE/12C	6.5m	250m	18g/m2
FLEECE/12	8.5m	250m	18g/m2
FLEECE/19	10.5m	250m	18g/m2
FLEECE/11C	12.8m	250m	18g/m2
FLEECE/14	13.8m	250m	18g/m2
FLEECE/16	14.2m	250m	18g/m2
FLEECE/09.1	16m	250m	18g/m2
FLEECE/10	18.2m	250m	18g/m2
FLEECE/02	1.6m	250m	30g/m2
FLEECE/06	2m	250m	30g/m2
FLEECE/08	3m	250m	30g/m2

CosyTex Fleece

CosyTex is made from a thermal knitted polythene. It doesn't puddle and allows moisture to pass through. CosyTex is ideal for use on field scale crops, nursery stock, bedding and soft fruit. Life span: 4 years permanent use and over 10 years seasonal use.



Code	Width	Length	Weight	Light Transmission
COSYTEX-2	2m	200m	38g/m2	> 86%
COSYTEX-4	4m	200m	38g/m2	> 86%
COSYTEX-6	6m	200m	38g/m2	> 86%
COSYTEX-8	8m	200m	38g/m2	> 86%
COSYTEX-10	10m	100m	38g/m2	> 86%
COSYTEX-12	12m	100m	38g/m2	> 86%
COSYTEX-16	16m	100m	38g/m2	> 86%

Netting & Fabrics

GeoPEX

Weed Control Fabric

GeoPEX Ground Cover

Manufactured in Europe GeoPex is a 100g/m2 woven geotextile that offers outstanding water porosity values and can be used as a weed control membrane in various landscape and greenhouse situations. GeoPex is UV treated and will provide extended weed control which can be increased by the use of a mulch material such as bark or hardcore.

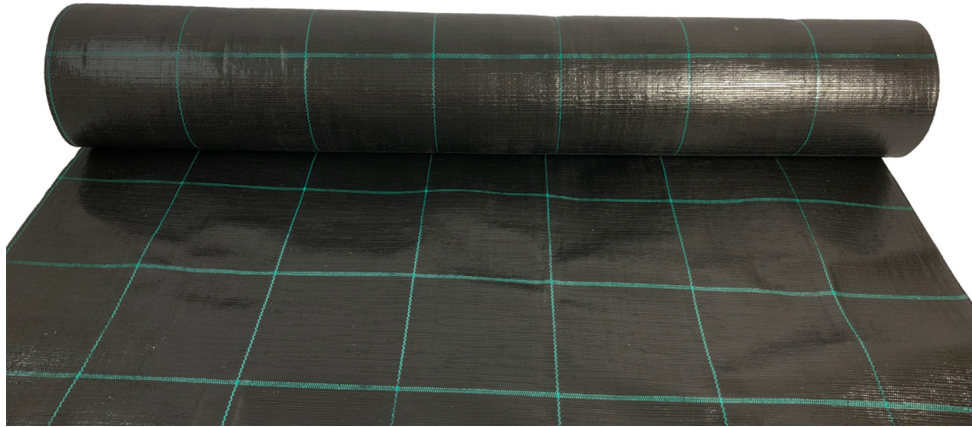

Code	Colour	Width	Weight	Grid Size	Length
GROU/01	Black	1.05m	100g/m2	25cm x 25cm	100m
GROU/1.5	Black	1.65m	100g/m2	25cm x 25cm	100m
GROU/02	Black	2.1m	100g/m2	25cm x 25cm	100m
GROU/03	Black	3.3m	100g/m2	25cm x 25cm	100m
GROU/04	Black	4.2m	100g/m2	25cm x 25cm	100m
GROU/05	Black	5.25m	100g/m2	25cm x 25cm	100m

GeoPex Joining Tape

Providing a very strong bond this tape is perfect for joining ground cover such as GeoPEX.

Code	Width	Length
GROU/07	19mm	45m
GROU/16	19mm	30m



GeoPEX

Weed Mats

Permatex premium weed mats are cut to centre making them ideal for use when planting trees. They can be fixed in place by using a plastic ground peg or simply mulch over them.

Code	Dimension	Pack Size
MAT-WEED-50/01	50cm x 50cm	100
MAT-WEED-100/01	1m x 1m	100



See page 156 for sheet pegs & fixings

Netting & Fabrics

Weed Control Fabric

Mulchtex

The Mulchtex range is a spun bonded polypropylene weed control fabric with high levels of UV stabiliser which allows air, nutrients and liquids to pass through. A spun bonded material, it can be easily cut without fraying. Available in a range of widths to cater for all levels of protection.



Code	Colour	Width	Weight	Length
MULCH/01	Black	1m	50g/m2	100m
MULCH/02	Black	1.5m	50g/m2	100m
MULCH/03	Black	2m	50g/m2	100m
MULCH/04	Black	3m	50g/m2	100m

Biotelo

Biotelo is a revolutionary 100% biodegradable mulching film, made from maize starch. It is the environmentally friendly alternative for weed control and reduces labour and landfill costs as it does not need to be removed or disposed of. Biotelo maintains its mulching ability for a minimum of one and a half months and a maximum of four and a half months (for autumn cycles).



Code	Life Expectancy	Colour	Width	Micron	Length
MULCH-BIO/02	2-3 months	Black	1.4m	12	2000m
MULCH-BIO/01	4-7 months	Black	1.4m	15	1500m

Windbreak Material

MonoPEX

Monofilament Windbreak & Shading

MonoPex monofilament 50 is a superior knitted windbreak constructed from high density polyethylene monofilament, it is designed to reduce wind speed by 50%. Supplied as standard with eyelets top and bottom for easy fixing, it is cost effective and light. Life expectancy 6-8 years.

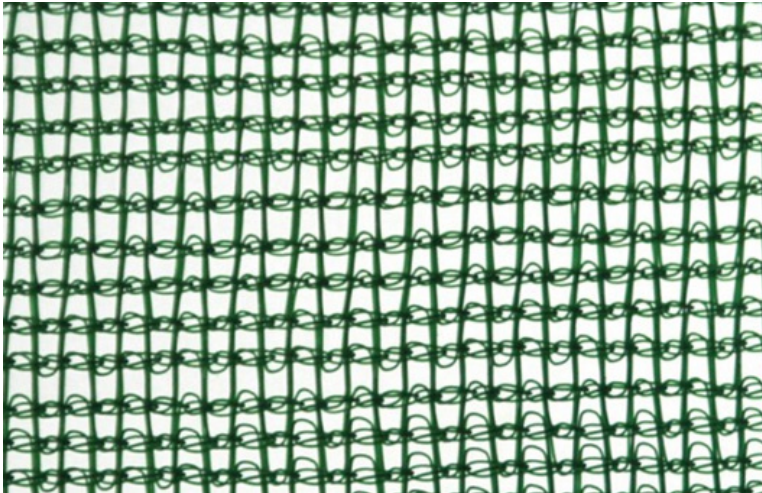

Code	Colour	Width	Shade Value	Weight	Length
WIND/06	Green	1m	50%	130g/m2	50m
WIND/07	Green	1.5m	50%	130g/m2	50m
WIND/08	Green	2m	50%	130g/m2	50m
WIND/09	Green	3m	50%	130g/m2	50m

Rokolene

Rokolene is a brand leader when it comes to artificial windbreaks, giving superior performance in all climatic conditions. Constructed from high density polyethylene tape threads, featuring a eyelet top and bottom for easy fixing.

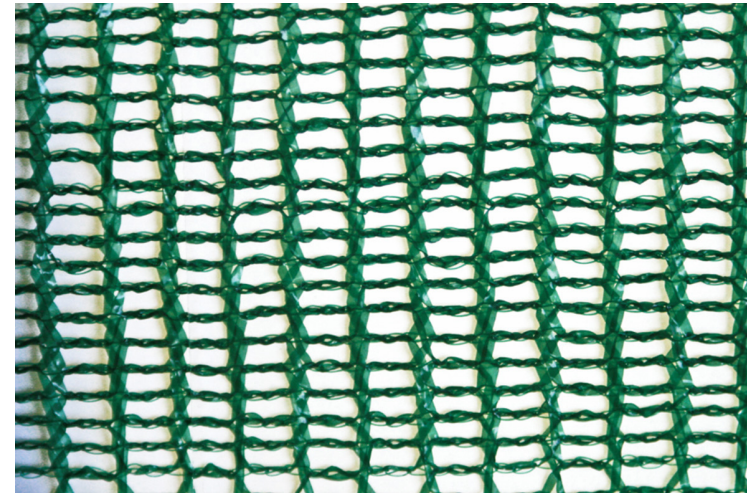

Code	Colour	Width	Shade Value	Weight	Length
WIND/22	Green	0.9m	50%	90g/m2	50m
WIND/13	Green	1.2m	50%	90g/m2	50m
WIND/14	Green	1.8m	50%	90g/m2	50m

Netting & Fabrics

Windbreak Material

Loktex

Loktex netting incorporates flat tape threads and double lock-stitch tearproof technology with button holes top and bottom. It is the ultimate knitted windproof product, dramatically reducing wind impact speeds to protect crops from wind, water loss, soil erosion, wind-borne diseases and heat loss. Loktex is used across the world as a reliable and trustworthy windbreak and shade material.

Life expectancy 8-10 years.

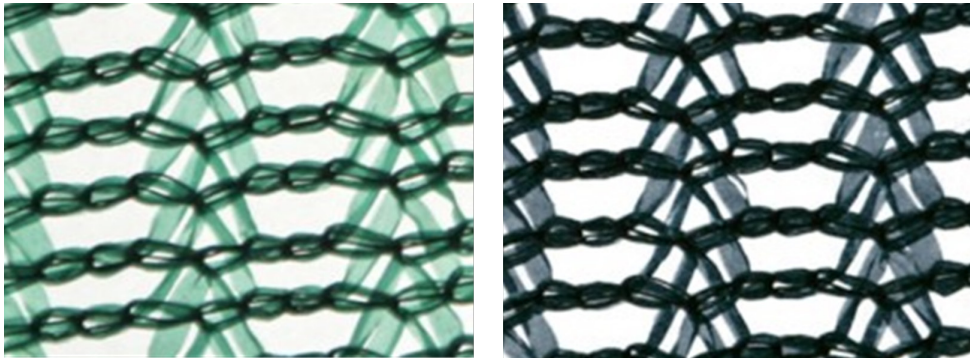

Code	Colour	Width	Shade Value	Weight	Length
LS5509101	Green	0.91	55%	90g/m ²	50m
LS5512202	Green	1.22m	55%	90g/m ²	50m
LS5518302	Green	1.83m	55%	90g/m ²	50m
LS5536602	Green	3.66m	55%	90g/m ²	50m
LS6309102	Green	0.91m	63%	100g/m ²	50m
LS6312202	Green	1.22m	63%	100g/m ²	50m
LS6318302	Green	1.83m	63%	100g/m ²	50m
LS6336602	Green	3.66m	63%	100g/m ²	50m

Protection Netting

Extruded Windbreaks

The heavy duty is more of a cladding type windbreak material with reinforced strands, making it a much stronger material.

- Shade value 50%
- Mesh size 15mm x 5mm
- Weight 300g/m²
- * Life expectancy 6-8 years

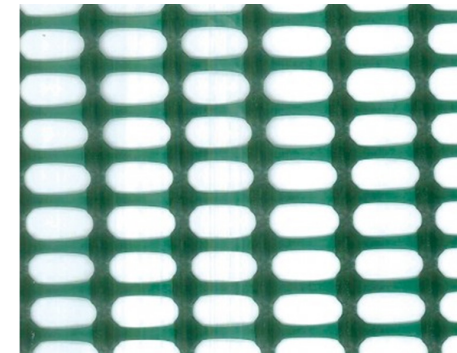

Code	Colour	Width	Shade Value	Mesh Size	Weight	Length
WIND/23	Black	1m	Heavy Duty 50%	15mm x 5mm	300g/m ²	30m
GREXT/21	Black	2m	Heavy Duty 50%	15mm x 5mm	300g/m ²	30m
WIND/20	Green	1m	Heavy Duty 50%	15mm x 5mm	300g/m ²	30m
WIND/02	Green	2m	Heavy Duty 50%	15mm x 5mm	300g/m ²	30m

Netting & Fabrics

Fruit Cage & Enclosure Netting

Extruded black plastic meshes ideal for fruit cages, protecting chicken coops and other enclosures from predators. They offer a cost effective alternative to traditional wire fencing.

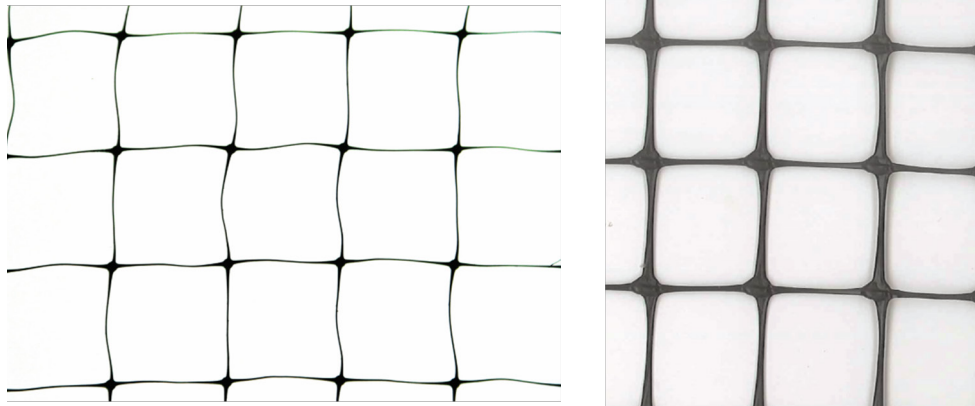

Code	Description	Mesh Size	Life Expectancy	Roll Length
EXT1005	2m Lightweight	20 x 20mm	5-7 Years	100m
GREXT01	2m Std Weight	18 x 18mm	8-10 Years	100m
FAST01	1m Premium	18 x 18mm	10+ Years	100m
FAST02	2m Premium	18 x 18mm	10+ Years	100m

Anti Bird Netting

Perfect for keeping birds out these HDPE nets have a soft nature to the material making them ideal for installing onto a structure or laying directly over the crop.



Code	Reference	Mesh Size	Length	Life Span
ANTI-BIRD/01	2m PN2 - Premium - black	20mm	100m	10 years
ANTI-BIRD/03	4m PN2 - Premium - black	20mm	100m	10 years
ANTI-BIRD/11	6m PN2 - Premium - black	20mm	100m	10 years
ANTI-BIRD/04	8m PN2 - Premium - black	20mm	100m	10 years
ANTI-BIRD/12	12m PN2 - Premium - black	20mm	50m	10 years
ANTI-BIRD/07	2m PN3 - Standard - green	18mm	100m	7 years
ANTI-BIRD/06	4m PN3 - Standard - green	18mm	100m	7 years
ANTI-BIRD/13	6m PN3 - Standard - green	18mm	100m	7 years
ANTI-BIRD/08	8m PN3 - Standard - green	18mm	100m	7 years
ANTI-BIRD/14	10m PN3 - Standard - green	18mm	100m	7 years

Netting & Fabrics

Protection Netting

Butterfly Netting

Protects plants and crops from butterflies with its extra small mesh size. Lightweight yet very strong and durable this netting is often used in conjunction with fruit cages.



Code	Width	Mesh Size	Weight	Length
ANTI-BUTT/01	2m	6mm x 7mm	44g/m2	150m
ANTI-BUTT/02	4m	6mm x 7mm	44g/m2	150m

Butterfly Netting

Our soft anti-butterfly netting is constructed from a soft woven material meaning that it can be laid directly onto the crop without causing damage. Ideal for use with crop and fruit cages.



Code	Width	Mesh Size	Weight	Length
ANTI-BUTT/03	4m	5mm x 7mm	70g/m2	100m
ANTI-BUTT/04	6m	5mm x 7mm	70g/m2	100m
ANTI-BUTT/05	8m	5mm x 7mm	70g/m2	100m

Extra Fine Insect Netting

Lightweight polythene UV inhibited netting that is available in various mesh sizes. Screens out insects, preventing damage to crops and the spreading of bacterial disease.



Code	Reference	Width	Length
NET-INSECT/01	IN50	1.83m	100m
NET-INSECT/04	IN50	3.66m	100m

Deer Fence

This black plastic mesh is the ideal solution to deter deer from entering any small or large areas. It's lightweight yet has high tensile strength, making it the ideal solution. The mesh is very cost effective compared to other options.

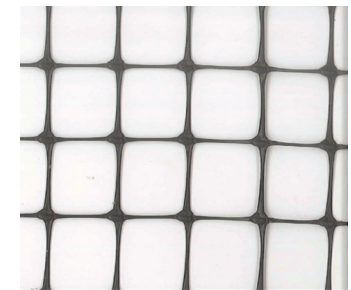

Code	Colour	Width	Mesh Size	Weight	Length	Life Span
FENCE-DEER/02	Black	1.8m	50mm x 50mm	80g/m2	100m	5 - 7 years
FENCE-DEER/01	Black	2m	50mm x 50mm	80g/m2	100m	5 - 7 years

Netting & Fabrics

Game Netting

Protect pheasants, other game and poultry from predators. Extruded and oriented black plastic mesh can be used as a cost effective alternative to traditional wire for creating pens and coops.

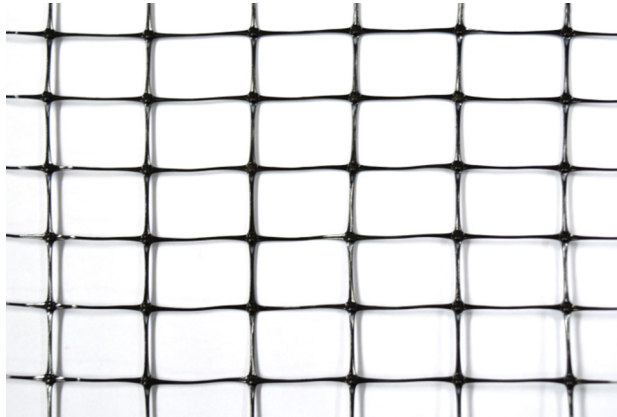

Code	Colour	Width	Mesh Size	Weight	Length	Life Span
NET-GAME/01	Black	1.2m	15mm x 22mm	60g/m ²	100m	5 - 7 years
NET-GAME/02	Black	1.5m	15mm x 22mm	60g/m ²	100m	5 - 7 years
NET-GAME/03	Black	2m	15mm x 22mm	60g/m ²	100m	5 - 7 years

Plastic Mesh

Polypropylene plastic garden meshes are strong extruded meshes with many different applications including tree protection, climbing support for plants, general fencing and compost retention.

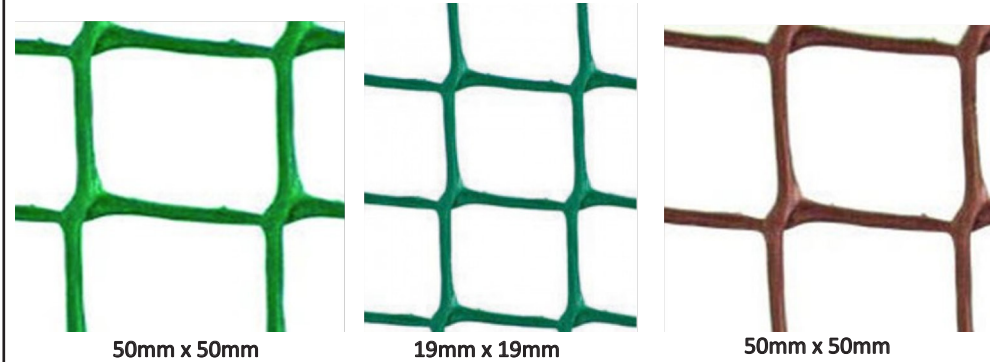

Code	Colour	Width	Mesh Size	Length
MESH-PLAS/01	Green	0.5m	50mm x 50mm	20m
MESH-PLAS/04	Brown	0.5m	50mm x 50mm	20m
MESH-PLAS/02	Green	1m	50mm x 50mm	20m
MESH-PLAS/06	Brown	1m	50mm x 50mm	20m
MESH-PLAS/03	Green	0.5m	19mm x 19mm	20m
MESH-PLAS/05	Green	1m	19mm x 19mm	20m

Netting & Fabrics

Plant Support Netting

Gladiator Plant Support

A strong but lightweight polypropylene net, ideal for vertical and horizontal support for climbing plants and vegetables. When used vertically, Gladiator plant support net can uphold even the heaviest of crops such as cucumbers, peas and beans. When used horizontally, it will provide support for flowers such as chrysanthemums, carnations and long stemmed roses. Successive layers can be added to allow for extra security as plants mature.

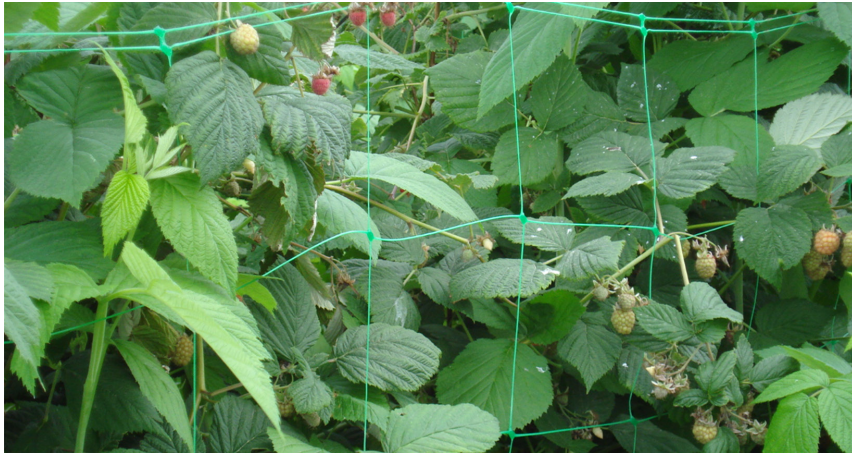

Code	Colour	Width	Mesh Size	Length
NET/12	Green	1.05m	150mm x 170mm	500m
NET/06	Green	1.53m	150mm x 170mm	500m
NET/02	Green	2.04m	150mm x 170mm	500m

Debris Netting

Standard Debris Netting

Standard debris netting is a cost effective way to protect the public and traffic on the ground from falling debris next to construction sites. Made from knitted high density polypropylene monofilament, the net allows air circulation and reduces rain and wind penetration, improving the working environment for construction personnel. Each size contains button holes for easy fixing.



Code	Colour	Width	Length
NET-DEBRIS/03	Green	1m	50m
NET-DEBRIS/02	Green	2m	50m
NET-DEBRIS/01	Green	3m	50m

Polythene

Bench Covers

Perforated Bench Polythene

Perforated Bench Cover is generally placed over the top of the layer of capillary matting thus keeping it clean. The film is perforated to allow irrigation water through to the Capillary matting and also in turn to allow the plants roots to take the water back up again when placed on the bench.

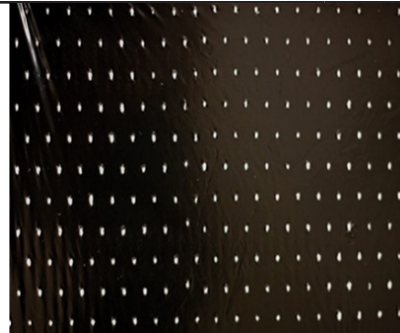

Available in Black & White.

Code	Description	Colour	Width	Length
POLY-BENCH/01	Plain Perforated Bench Polythene	Black	1.2m	250m
POLY-BENCH/04	Plain Perforated Bench Polythene	Black	1.2m	500m
POLY-BENCH/02	Plain Perforated Bench Polythene	Black	1.5m	250m
POLY-BENCH/03	Plain Perforated Bench Polythene	Black	2.1m	250m
POLY-BENCH/09	Plain Perforated Bench Polythene	White	1.25m	250m
POLY-BENCH/05	Plain Perforated Bench Polythene	White	2.0m	250m

Symbol Sheet

Symbol sheet is a microperforated bench film that has all the characteristics of our perforated bench film, in addition it has 4 different spacing systems for accurate spacing of pots, each by its own symbol.

Figure	Centre to Centre Spacing	Number Of Pots
Dot	124mm	6.94 ft2 / 74.7m2
Circle	142mm	5.36 ft2 / 57.7m2
Triangle	166mm	3.98 ft2 / 42.9m2
Square	199mm	2.79 ft2 / 30.2m2

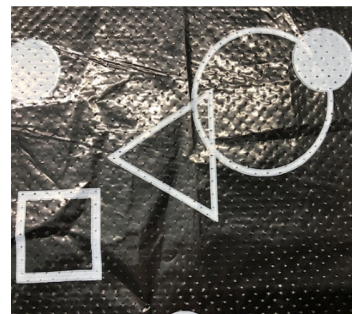

Code	Colour	Thickness	Width	Length
POLY-BENCH-SYM	Black + symbols	40mu	2m	300m

Narrow Films

Narrow Films

Our range of narrow films come in a variation of sizes and thickness's to suit all horticultural situations. Most films are UV stabilised to extend film life. The Black/White film is coextruded: black on one side and white on the other.



Bespoke films can be manufactured, the minimum order for these films is usually 250kg.

Code	Colour	Width	Thickness	Length
POLY-BLACK/06	Black	1.4m	35mu	900m
POLY-BLACK/01	Black	1.3m	38mu	400m
POLY-BLACK/04	Black	1m	50mu	600m
POLY-BLACK/05	Black	1.4m	100mu	100m
POLY-BLACK/07	Black	2m	100mu	100m
POLY-BLACK/03	Black / White	2m	85mu	150m
POLY-CLEAR/03	Clear	1.85m	38mu	200m
POLY-CLEAR/04	Clear	3.7m	38mu	200m
POLY-CLEAR/05	Clear	1.5m	125mu	100m
POLY-CLEAR/07	Clear	1.85m	125mu	100m
POLY-CLEAR/08	Clear	3.7m	125mu	50m
POLY-CLEAR/06	Clear	1m	250mu	100m
POLY-WHITE/01	White	2m	30mu	400m
POLY-WHITE/02	White	3.6m	70mu	300m

Polythene

Bubble Polythene

With its major heat-saving properties, Bubble Insulation provides growers with a cost effective solution to heat loss in glasshouses and cold frames. Manufactured from three-ply UV stabilised film in large bubble format, Bubble Insulation effectively protects vulnerable plants and shrubs from frost damage.

- UV Protected
- Energy saving
- Cleans easily
- Large 25mm bubble

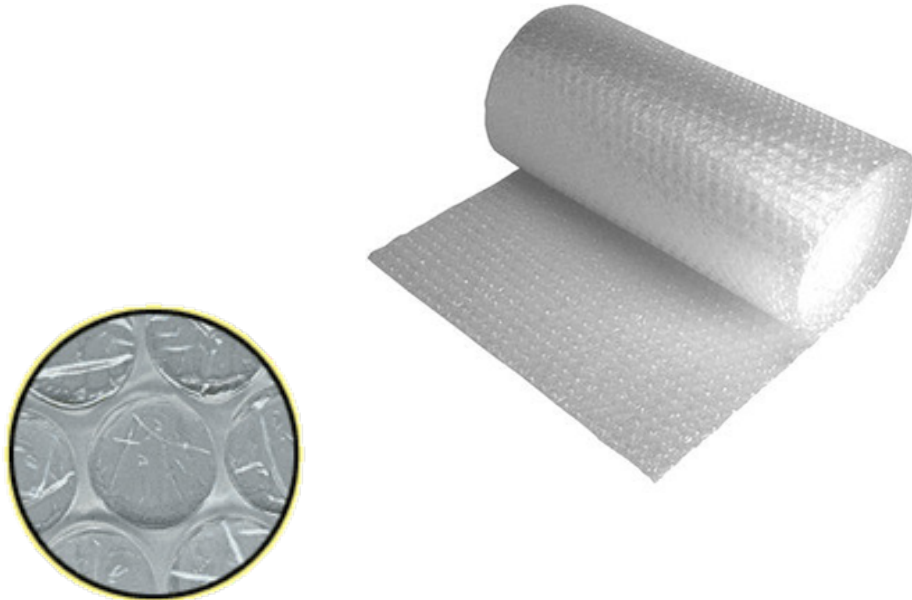

Code	Width	Length
POLY-BUBBLE/1.5	1.5m	50m
POLY-BUBBLE/2.4	2.4m	50m

Alliplug

Standard Alliplug is for securing Bubble Polythene to polytunnels or greenhouses.

Code	Description	Pack Qty
ALLI/02	Alliplug	500



Super Alliplug

The Super Alliplug is a shading clip with a washer for securing Bubble Polythene to polytunnels or greenhouses.

Code	Description	Pack Qty
ALLI/01	Super Alliplug	500



Alliplug Extender

The Alliplug extender is used in conjunction with an Alliplug, it helps ensure sufficient gaps between the glass and polythene to allow good airflow.

Code	Description	Pack Qty
ALLI/04	Alliplug Extender	500



Polythene

Tunnel Covers

Lumisol Clear															
<p>Lumisol clear is a clear cover with UV “Transparent “ characteristics incorporated. This sheet transmits a high % of UV light which can assist the colour, flavour & fragrance in a wide range of flowers and fruit crops.</p> <p>This sheet is manufactured using Visqueen’s 7 Layer blown co-extrusion technology that maximises the individual performance characteristics of each cover.</p> <p>All sheets are cut to length as required. If you need help with ordering the correct size, please call or email</p>				<table border="1"> <thead> <tr> <th colspan="2">Roll Widths</th> </tr> </thead> <tbody> <tr> <td>7.3m</td> <td>✓</td> </tr> <tr> <td>9.2m</td> <td>✓</td> </tr> <tr> <td>11.m</td> <td>✓</td> </tr> <tr> <td>14m</td> <td>✓</td> </tr> </tbody> </table>		Roll Widths		7.3m	✓	9.2m	✓	11.m	✓	14m	✓
Roll Widths															
7.3m	✓														
9.2m	✓														
11.m	✓														
14m	✓														
Life Span	Light Transmission	Thickness	Thermic Effect	Light Diffusion	Minimum Length										
5 Season	>88%	720g (180mu)	>80%	<35%	10m										

Lumisol Diffused															
<p>Lumisol Diffused is a very high diffusing cover which incorporates a UV “Transparent” characteristic. It will transmit a high % of UV light which can assist the colour, flavour and fragrance in a wide range of flowers and fruit crops.</p> <p>This sheet is manufactured using Visqueen’s 7 Layer blown co-extrusion technology that maximises the individual performance characteristics of each cover.</p> <p>All sheets are cut to length as required. If you need help with ordering the correct size, please call or email</p>				<table border="1"> <thead> <tr> <th colspan="2">Roll Widths</th> </tr> </thead> <tbody> <tr> <td>7.3m</td> <td>✓</td> </tr> <tr> <td>9.2m</td> <td>✓</td> </tr> <tr> <td>11.m</td> <td>✓</td> </tr> <tr> <td>14m</td> <td>✓</td> </tr> </tbody> </table>		Roll Widths		7.3m	✓	9.2m	✓	11.m	✓	14m	✓
Roll Widths															
7.3m	✓														
9.2m	✓														
11.m	✓														
14m	✓														
Life Span	Light Transmission	Thickness	Thermic Effect	Light Diffusion	Minimum Length										
5 Season	>88%	720g (180mu)	>80%	>90%	10m										

White UVI															
<p>This white cover has shade producing properties for use when growing nursery stock. This sheet is manufactured using Visqueen’s 7 Layer blown co-extrusion technology that maximises the individual performance characteristics of each cover.</p> <p>All sheets are cut to length as required. If you need help with ordering the correct size, please call or email</p>				<table border="1"> <thead> <tr> <th colspan="2">Roll Widths</th> </tr> </thead> <tbody> <tr> <td>9.2m</td> <td>✓</td> </tr> <tr> <td>11.2m</td> <td>✓</td> </tr> <tr> <td>12.5m</td> <td>✓</td> </tr> <tr> <td>15m</td> <td>✓</td> </tr> </tbody> </table>		Roll Widths		9.2m	✓	11.2m	✓	12.5m	✓	15m	✓
Roll Widths															
9.2m	✓														
11.2m	✓														
12.5m	✓														
15m	✓														
Life Span	Light Transmission	Thickness	Thermic Effect	Light Diffusion	Minimum Length										
5 Season	60-70%	720g (180mu)	>55%	>85%	10m										

Green / White																			
<p>This cover offers complete opacity which has been formulated for mushroom growers.</p> <p>This sheet is manufactured using Visqueen’s 7 Layer blown co-extrusion technology that maximises the individual performance characteristics of each cover.</p> <p>All sheets are cut to length as required. If you need help with ordering the correct size, please call or email</p>				<table border="1"> <thead> <tr> <th colspan="2">Roll Widths</th> </tr> </thead> <tbody> <tr> <td>8.5m</td> <td>✓</td> </tr> <tr> <td>10.5m</td> <td>✓</td> </tr> <tr> <td>12.5m</td> <td>✓</td> </tr> <tr> <td>14m</td> <td>✓</td> </tr> <tr> <td>14.5m</td> <td>✓</td> </tr> <tr> <td>16m</td> <td>✓</td> </tr> </tbody> </table>		Roll Widths		8.5m	✓	10.5m	✓	12.5m	✓	14m	✓	14.5m	✓	16m	✓
Roll Widths																			
8.5m	✓																		
10.5m	✓																		
12.5m	✓																		
14m	✓																		
14.5m	✓																		
16m	✓																		
Life Span	Light Transmission	Thickness	Thermic Effect	Reflectivity	Minimum Length														
5 Season	>2%	800g (200mu)	>55%	>70%	10m														



Tunnel Covers

Sterilite Superthermic				
Use Sterilite SuperThermic for all crops which are heated and where the advantages of the UV blocking IPM will be advantageous, for example organic growing. UV blocking is proven to reduce fungal and aphid attacks and give a greater foliage area. Great for vegetables, especially salad crops.				
All sheets are cut to length as required. If you need help with ordering the correct size, please call or email.				
7.3m	9.2m	11.1m	14m	Min Cut
✓	✓	✓	✓	5m
Specification				
UV guaranteed life		5 Years		
Life Expectancy		8+ Years		
Diffusion (400-700nms)		45%		
Anti Mist / Drip		Yes		
Light Transmission		~89%		
Thermicity		92%		
Temperature reducing		Yes		
Total UV (300-390nms)		<1%		
Stretch before break*		600%		

Sunmaster Superthermic				
Use SunMaster SuperThermic for all crops where frost protection is important. Normal polythene and glass block the UV below a certain level (350nms), SunMaster films give you the advantages of growing indoors without losing the benefit of the outdoor sunlight.				
All sheets are cut to length as required. If you need help with ordering the correct size, please call or email.				
7.3m	9.2m	11.1m	14m	Min Cut
✓	✓	✓	✓	5m
Specification				
UV guaranteed life		5 Years		
Life Expectancy		8+ Years		
Diffusion (400-700nms)		45%		
Anti Mist / Drip		Yes		
Light Transmission		~89%		
Thermicity		92%		
Temperature reducing		Yes		
Total UV (300-390nms)		<60%		
Stretch before break*		600%		

Sunmaster Diffused				
Use SunMaster Diffused for all crops where colour is important - especially reds and blues - and over wintered nursery stock where only a slight frost protection is required. SunMaster Diffused comes with anti-fog/ anti-drip as standard. This film is designed with 60% diffusion which is optimal for UK growing conditions for most crops.				
All sheets are cut to length as required. If you need help with ordering the correct size, please call or email.				
7.3m	9.2m	11.1m	14m	Min Cut
✓	✓	✓	✓	5m
Specification				
UV guaranteed life		5 Years		
Life Expectancy		8+ Years		
Diffusion (400-700nms)		60%		
Anti Mist / Drip		Yes		
Light Transmission		~89%		
Thermicity		N/A		
Temperature reducing		Yes		
Total UV (300-390nms)		<60%		
Stretch before break*		600%		

Sunmaster Clear				
Use SunMaster Clear for all crops where colour is important - especially reds and blues - and where high light levels in the early part of the year are important. Good for over wintered nursery stock where only a slight frost protection is required. Bear in mind that, with only a low level of diffusion, this film will be hotter in the summer than a diffused film. All sheets are cut to length as required. If you need help with ordering the correct size, please call or email.				
7.3m	9.2m	11.1m	14m	Min Cut
✓	✓	✓	✓	5m
Specification				
UV guaranteed life		5 Years		
Life Expectancy		8+ Years		
Diffusion (400-700nms)		25%		
Anti Mist / Drip		Yes		
Light Transmission		~91%		
Thermicity		N/A		
Temperature reducing		No		
Total UV (300-390nms)		<60%		
Stretch before break*		600%		



Tunnel Covers

SunSmart Blue				
Use SunSmart Blue for all bedding plant production and for shade loving shrubs that need dwarfing.				
SunSmart Blue naturally gives a height reduction in the spring without using any chemicals. For instance, Pansies will be reduced in height by 50% and, as example of Nursery Stock, Hydrangeas.				
All sheets are cut to length as required. If you need help with ordering the correct size, please call or email.				
7.3m	9.2m	11.1m	14m	Min Cut
x	✓	x	✓	5m
Specification				
UV guaranteed life		5 Years		
Life Expectancy		8+ Years		
Diffusion (400-700nms)		30%		
Anti Mist / Drip		Yes		
Light Transmission		~55%		
Thermicity		79%		
Temperature reducing		Yes		
Total UV (300-390nms)		<60%		

SunSmart Green				
Use SunSmart Green for all crops which are naturally shade loving: Ferns, Hostas, Hellebores, Laurels, Ilex, Camellias, Violets, Rhododendrons etc. and any other plants whose natural habitat is shade or semi shade.				
Can also be used for sheep.				
All sheets are cut to length as required. If you need help with ordering the correct size, please call or email.				
7.3m	9.2m	11.1m	14m	Min Cut
x	✓	x	✓	5m
Specification				
UV guaranteed life		5 Years		
Life Expectancy		8+ Years		
Diffusion (400-700nms)		30%		
Anti Mist / Drip		Yes		
Light Transmission		~66%		
Thermicity		N/A		
Temperature reducing		Yes		
Total UV (300-390nms)		<60%		

Sunmaster Cool				
SunMaster Cool has replaced StockMaster White and has been designed for growing plants that like to be kept cool in the Summer but still like a lot of light.				
SunMaster Cool uses the latest microfine Aluminium diffuser which makes your tunnel ~25% cooler in bright sunlight than a clear film.				
Can also be used for sheep and poultry.				
All sheets are cut to length as required. If you need help with ordering the correct size, please call or email.				
8m	10m	12m	14m	Min Cut
✓	✓	✓	✓	5m
Specification				
UV guaranteed life		6 Years		
Life Expectancy		10 Years		
Diffusion (400-700nms)		50%		
Anti Mist / Drip		Yes		
Light Transmission		~80%		
Thermicity		<17%		
Temperature reducing		Yes		
Total UV (300-390nms)		<50%		

Total Block - Black/White				
Use SunMaster Total Block for Mushroom sheds or where no light is required, for example storage.				
<ul style="list-style-type: none"> • Use the black side out for maximum light block. • Use white side out for poultry 				
All sheets are cut to length as required. If you need help with ordering the correct size, please call or email.				
8m	10m	12m	14m	Min Cut
x	x	✓	✓	5m
Specification				
UV guaranteed life		5 Years		
Life Expectancy		8+ Years		
Diffusion (400-700nms)		45%		
Anti Mist / Drip		Yes		
Light Transmission		~89%		
Thermicity		92%		
Temperature reducing		Yes		
Total UV (300-390nms)		<60%		

Polythene

Side Vent Film

Sunmaster Side Vent Polythene

Using Sunmaster Diffused polythene our side vent film is available plain or with a 70mm deep pocket. Minimum run is 30m

Specification	
UV guaranteed life	5 Years
Life Expectancy	8+ Years
Diffusion (400-700nms)	60%
Anti Mist / Drip	Yes
Light Transmission	~89%
Thermicity	N/A
Temperature reducing	Yes
Total UV (300-390nms)	<60%



Code	Product
SIDE-VENT/01	Side Vent Polythene 2m Plain (m)
SIDE-VENT/02	Side Vent Polythene 2m c/w 70mm Pocket (m)
SIDE-VENT/03	Side Vent Polythene 3m Plain (m)

Tunnel Tapes

Anti Hot-Spot Tape

Place over polytunnel hoops to prolong the life of the polythene cover by reducing abrasion and heat degradation.

Our AHST is made from a polythene foam so no matter what happens it won't damage your polythene.

Anti Hot Spot Repair tape is also available, it puts a new, smooth outer surface onto AHST which is starting to wear out.



Code	Description	Width	Roll Length
ANTI-HOT/05	Anti Hot Spot Tape	25mm	20m
ANTI-HOT/03	Anti Hot Spot Tape	30mm	20m
ANTI-HOT/01	Anti Hot Spot Tape	50mm	20m
ANTI-HOT/02	Anti Hot Spot Tape	30mm	9m
ANTI-HOT/04	Anti Hot Spot Tape	50mm	9m
ANTI-REPAIR	Anti Hot Spot Repair Tape	50mm	50m

Polytunnel Repair Tape

Our clear polythene tape is UV resistant and manufactured to a very high quality including a special adhesive which guarantees exceptional adhesion in varying weather conditions.

Code	Width	Colour	Roll Length
TAPE-AW/01	75mm	Clear	25m
TAPE-AW/02	100mm	Clear	25m
TAPE-AW/03	150mm	Clear	25m



Sulphur Vaporisation

Sulfume

The Hotbox Sulfume sulphur vaporiser helps to protect crops from fungal diseases such as Mildew, Botrytis and Black Spot. It also inhibits the spread of greenhouse pests.

- **Unique temperature control** – cannot overheat the sulphur to create damaging oxides, releases ONLY pure sulphur
- **Regulated element** – makes combustion impossible, eliminates the risk of fire and makes the Sulfume the safest on the market
- **Energy efficient** – the lowest energy consuming sulphur evaporator available
- **Flexible voltage** – can work on any supply from 110V to 250V, with no loss of performance in low voltage areas
- **Manufactured in high quality materials** – to ensure durability
- **Ideal for roses, strawberries, begonias, saint paulia, tomatoes, peppers and gerbera**

COVERAGE:

By using a uniform shaped cup, positioned accurately within the centre of the Sulfume cylinder, distribution is ensured through the natural funnel effect. One Sulfume is capable of treating between 100 – 1000m². Up to 100 Sulfumes may be needed per hectare depending on the crop and severity of fungal problems.



Code	Diameter	Height	Description	Unit Of Sale
SULFUME/01	13cm	18cm	Sulfume Vaporiser	each
SULFUME/02	13cm	18cm	Sulfume Vaporiser + 2kg Sulphur	each
SULPH-BURN/01	-	-	Burning Sulphur	2kg
SULPH-BURN/02	-	-	Burning Sulphur	10kg

Heaters

Superb Fan Heater 2.8kW

The HotBox Superb is a 2.8kW electronic fan heater. With Winter and Summer settings, it can help to keep your glasshouse cool or warm depending on the season.

- **Half and full heat settings** ensures maximum fuel economy
- **Fan only setting** use purely for air circulation
- **Fitted with feet and hanging loops** easy to install in the optimum position
- **High output fan (250cfm, 450m³/hr)** removes air quickly and efficiently



Code	Voltage	Power	Diameter	Length	Weight	Unit Of Sale
HEATER/02	230v	12amp	27cm	50cm	6.1kg	Each
HEATER/02B	110v	6amp	27cm	50cm	6.1kg	Each

Air Circulation

Sirocco

Following in the footsteps of the Hotbox Superb, but by no means standing in its shadow. The Hotbox Sirocco has all the advantages and privileges of being “born” into the established Hotbox fold, ie a modern design, accurate thermostatic control, a powerful 1.8kW motor, as well as our standard 2 year guarantee.



Code	Length	Diameter	Motor	Airflow	Unit Of Sale
HEATER/04	25cm	21cm	1.8kW	400m3/hr or 230cfm	Each

Mistraal Fans

Controlled air circulation in glasshouses and polythene tunnels can :

- Help to prevent botrytis and mildew
- Improve heat distribution and carbon dioxide take up
- Reduce condensation
- Remove temperature gradients



AIR CIRCULATION is one of the most important factors within the greenhouse for controlled growing. Efficiency, top quality and reliable units are a must, therefore a Hotbox Mistraal Air Circulation Fan is a must.

Manufactured from robust stainless steel, there are three Mistraal air circulation fans to choose from. With sealed ‘oiled for life’ motors to IP34, they are designed for maintenance free, continuous running.

Code	Model	V	RPM	Output	Unit Of Sale
FAN/01	Mistraal 24	220/240	1400	4000m3/hr	Each
FAN/02	Mistraal 10	220/240	1300	1600m3/hr	Each
FAN/03	Mistraal 5	220/240	1275	900m3/hr	Each

Heating

Thermabed

Hotbox Thermabed is a water-based system for root zone heating. Made to measure and designed to encourage germination and propagation, Thermabed is ideal for areas of 50m² or larger.

- Optimum growing temperature – precise thermostatic control from 6 to 38°C
- Quick and easy to install – on the ground or on benches
- Energy efficient – inexpensive to run on gas, oil, solid fuel or bio-fuel
- Durable construction – reliability built-in
- Simple design – low maintenance costs

The Hotbox Thermabed system consists of moulded expanded polystyrene panels which fit together to form the required area. These panels have a channel which forms a continuous loop into which a flexible water pipe is fitted. The unique design is arranged so that the water inlet pipe and the water outlet pipe run side by side, thus providing a uniform temperature over the entire surface. The Hotbox Thermabed system comes complete with polystyrene panels, flexible piping, inter connectors and BSP Valves.

The system is made to measure and panels will be cut in house to the width required.



The Hotbox Thermabed system can be covered with a variety of materials depending upon the crop to be grown.

Code: THERMABED

Heatwave Panels

The Hotbox Heatwave is a made-to-measure bench heating system which encourages germination, propagation and growth of seedlings and cuttings by delivering constant, uniform heat to the base of seed trays and plant pots.

Optimum growing temperature – precise thermostatic control from 6 to 38°C

- Easy to install – on the ground or on benches, just plug in and plant up
- Energy efficient – inexpensive to run
- Durable construction – reliability built-in
- Flexibility- operate more than one Heatwave from a single thermostat control

INSTALLATION.....This system is very simple to install and requires no specialist knowledge, just an electrical socket.

HEAT DISTRIBUTION.....The Heatwave root zone heating system is the only method available that can guarantee an even spread of heat across the entire surface.

Contact us with your measurements to get a made to measure quote.



Code: PANEL-HWP

Environment Control

Soil Warming Cables

Soil warming cable for fast germination and healthy growth in the greenhouse.

The Bio Green soil heating cable brings heat exactly where it is needed. It is particularly suitable for self-made propagators and the greenhouse. The flexible soil heating cable can be laid without problems according to your individual wishes. Countless installation options and possible applications make the watertight heating cable a universal heat source.

- Warms the soil by 8-12°C
- Especially suitable for seed propagation



Code	Power	Length	Unit Of Sale
SOIL/02	100w	10m	Each
SOIL/03	320w	25m	Each

TER2 Digital Thermostat

Greenhouse thermostat "Thermo2Digital" - Save even more energy with electronic control!

Whether heating, ventilating or cooling - the greenhouse thermostat "Thermo2Digital" is your ideal controller for all climate control systems. Set the temperature and, for example, directly control the electrical heating or the heating cable.

With the greenhouse thermostat "Thermo2Digital" you can even cool your greenhouse while the recirculation function helps you avoid dew.



Code	Range	Sensor Length	Unit Of Sale
THERM/06	-50 to +40°C	1.5m	Each

Jet Force Diesel/Kerosene Space Heater

Suitable for well ventilated spaces. Fitted with a thermostatic control unit, automatic ignition and photocell safety device. The in-line fuel filter gives reliable operation time and time again while the clean burning unit operates on both kerosene and diesel. Producing an impressive 175,000 Btu/hr, the 50ltr fuel tank gives approximately 10hrs continuous running time, making the unit extremely fuel efficient and economical.

Specification	
Max. heat output	175,000 BTU (51kW)
Motor	200W
Air Flow	874m ³ min (514cfm)
Max. fuel consumption	5L/h
Tank Capacity	50lt
Suggested Heating Area	Up to 28,000 cu. ft
Dimensions	970 x 420 x 660mm
Weight (approx.)	30kg



Code	Stock No	Part Number	Unit Of Sale
HEATER/05	32284	DSH1750	Each

Heating

AIRREX Diesel Infra Red Heaters

AIRREX is the market leader of diesel-powered infrared heaters. AIRREX infrared heaters have been manufactured for almost 30 years, and the factory's product development department alone employs approximately 40 people, so AIRREX is a global trendsetter in products like these.

Auxiliary diesel heaters developed by AIRREX produce safe infrared radiation. The heat produced by the infrared heater spreads evenly into the structures of the space or site to be heated. A separate fan is not needed. The heating effect is quick, and the patented oil burner and exhaust piping utilise practically 100% of the energy included in the fuel.

- No separate exhaust pipe needed: The heater does not emit burning smells or visible smoke. An exhaust pipe is only necessary in areas where people sleep.
- Easy to install and move around: Just fill the fuel tank and plug in.
- Low emissions: Emissions are only 3.3g / h. Mostly just a little bit of water (8.8%) and carbon dioxide are emitted.

CONSUMPTION EXAMPLE AH-300G

- > Isolated industrial workspace, capacity 500m3
- > Temperature outside: 0°C, Inside: +15°C
- > Fuel consumption per day: approx. 2.5lt

WHY USE A INFRARED HEATER?

In a area equipped with an infrared heater, all materials are warm so a lot of heat energy is retained even after the air change. In an area equipped with a fan heater, all the heat escapes out of the door, and heating must be started over at a much lower temperature. As such, the infrared heater needs much less energy.

1. EFFECTIVE NOISE REDUCTION
The noise reduction system in the exhaust pipe, which compresses and expands the exhaust gases, makes Airrex extremely quiet - only 48 dB.

2. PURE COMBUSTION
The triple combustion process guarantees completely pure combustion; the heater does not need a separate exhaust pipe, which conserves all heat for utilisation. Normal ventilation is sufficient.

3. SOFT-TOUCH CONTROL PANEL
Easy-to-use soft-touch control panel with LED display and remote control.

4. ADVANCED BURNER
The device has an oil burner equipped with an electric fuel pump, which recycles the exhaust through pipes with ceramic coatings, giving out the heat as infrared radiation.

FUEL PRE-HEATING
Starts well also in the cold weather.

ONLY ON AIRREX!

EASY TO USE AND POWERFUL INFRARED HEATER!

Code	Model	Area Suitability	Weight	Dimensions (W x D x H)	Heating Capacity	Suitable Fuels	Fuel Tank Volume	Power Consumption	Noise Level	Temperature Adjustment Range
HEATER-AH-200	AH-200	approx. 900m3	33kg	30.5cm x 78cm x 95cm	13kW/h	Biodiesel, diesel or red diesel	25lt	80 W (230 v, 50 Hz)	48dB	0-40c
HEATER-AH-300	AH-300	approx. 1500m3	41kg	30.5cm x 95cm x 100cm	15kW/h	Biodiesel, diesel or red diesel	45lt	80 W (230 v, 50 Hz)	48dB	0-40c
HEATER-AH-800	AH-800	approx. 2000m3	81kg	1300cm x 350cm x 1400cm	22kW/h	Biodiesel, diesel or red diesel	70lt	80 W (230 v, 50 Hz)	48dB	0-40c

Propagation

Growbox Heated Propagator

The Hotbox Propagator delivers accurate, uniform heat to the base of the seed trays, to promote the germination of seeds or root cuttings.

- **Simple to put together** – comes part built but some parts require connecting
- **Energy efficient** – inexpensive to run, no need to heat the whole greenhouse
- **Optimum growing temperature** – precise thermostatic control from 6 to 38°C
- **Durable construction** – reliability built-in
- **Space saving design** – overall dimensions length 1.5m, width 0.75m

The Propagators aluminium base which encloses the heating element ensures that seed trays receive accurate and uniform heat for propagation.

The thermostat sensor is placed into the growing medium to obtain the correct temperature for maximum germination and rooting rates.

The Polycarbonate top (which is assembled on site) will protect the young plants and provide a mini climate several degrees higher than the surrounding temperatures in the greenhouse. Therefore there may not be any need for additional background heating in the greenhouse.



Code	Length	Width	Voltage	Power	Capacity	Unit Of Sale
GROWBOX	1.5m	75cm	110V or 230V	165W	Up to 12 seed trays	Each

CO2 Generation

CO2 Generator

Hotbox CO2 Generators enrich the atmosphere and encourage plant growth. There are three models to choose from, suitable for growing areas ranging from 20m² to 4000m².

- Increase CO2 to 1000 ppm – achieve optimum growing environment
 - Low running cost – runs on propane or natural gas (all of the CO2 Generators are supplied as propane with a conversion kit for natural gas)
- Easy installation – simply attach to supply, plug in and switch on
Robust, lightweight construction – durable, yet easy to move around

N.B. CARBON DIOXIDE AND AIR CIRCULATION

Plants can only absorb carbon dioxide near to them. Carbon dioxide is also heavier than air and will tend to fall to the base of the growing area. Best results are achieved by good air circulation.

Hotbox Mistral air circulation fans have been developed for this purpose.



Model Number	Dimensions	Weight	CO2 Per Hour	1000 ppm per m of greenhouse
2.5	32 x 20 x 50	5kg	0.55kg	55m2
4	32 x 20 x 50	5kg	0.9kg	90m2
11	70 x 20 x 90	5kg	2.5kg	250m2

Packaging

Bags

Polythene Produce Bags

These bags come on a wire wicket for easy dispersal.



Code	Size	Colour	Unit Of Sale
LETT/01	30.0cm x 22.5cm	Clear	5000
BAG/04	30.5cm x 35.5cm	Clear	3000

Multipurpose Net Bags

Ideal for logs, kindling, carrots, sprouts and many other uses. Complete with drawstring. Part packs available by special request.



Code	Size	Colour	Unit Of Sale
NET/03	50 x 80	Orange	1000
NET/08	45 x 65	Orange	1000
NET/13	43 x 60	Green	1000
NET/ 11	35 x 50	Green	1000
NET/04	31 x 35	Green	1000
NET/05	20 x 28	Red	2000

Hand Pallet Wrap

Our 17mu high performance extended core hand pallet wrap can be applied by hand or by using a dispenser which increases efficiency.

- Available in Clear & Black

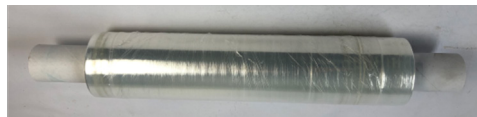

Code	Width	Length	Thickness	Colour	Box Qty	Unit Of Sale
SHRINK/01	300mm	400m	17mu	Clear	6	Each
SHRINK/02	500mm	250m	17mu	Black	6	Each

Perforated Pallet Wrap

Pre-stretched to give maximum aeration. Fully re-enforced to support any load in transit. Roll length and weight make it comfortable to use. Unlike other materials, this film sticks to itself on cutting, therefore there is no need for expensive sealing systems.



Code	Width	Length	Colour	Box Qty	Unit Of Sale
SHRINK/04	500mm	300m	Clear	6	Each

Packaging

Baskets & Punnets

P.Y.O Baskets		
Conventional (6lb) 2.72kg " Pick Your Own" basket with tabbed handle. Supplied with a green inner and the standard P.Y.O print.		
Code	Colour	Unit Of Sale
LETT/01	Green & White	25



Fruit Punnets & Lids

A range of fruit punnets and lids to suit all your needs.

- Recyclable
- Lightweight
- Produced in RPET material



Code	Reference	Description	Length	Width	Height		Unit Of Sale
PUNNET/04	C250-50	Punnet 250g (1/2lb)	145mm	95mm	50mm	✓	2200
PUNN-LID/01	LC250-25	Lid For C250-50	146mm	97mm	25mm	✓	1100
PUNNET/05	C512-75	Punnet 500g (1lb)	145mm	120mm	75mm	✓	1500
PUNN-LID/02	K30C	Lid For C512-75	150mm	125mm	20mm	✓	550
PUNNET/03	HP37-60	Oblong Punnet 500g (1lb)	184mm	118mm	60mm	✓	600
PUNN-LID/03	HP37	Lid For HP37-60	188mm	122mm	10mm	✓	540

Bands

Rubber Bands

Rubber elastic bands for binding and storing a range of items.

- High latex content which means they can be used over and over again
- Available in a range of sizes , including thick heavier duty bands



Code	Size	Band Thickness	Length	Bag Weight
BAND-10	10	1.5mm	35mm	454g
BAND-14	14	1.5mm	51mm	454g
BAND-19	19	1.5mm	89mm	454g
BAND-22	22	1.5mm	100mm	454g
BAND-24	24	1.5mm	150mm	454g
BAND-32	32	3mm	76mm	454g
BAND-34	34	3mm	100mm	454g
BAND-38.5	38.5	3mm	160mm	454g
BAND-61	61	6mm	50mm	454g
BAND-65	65	6mm	100mm	454g
BAND-69	69	6mm	160mm	454g
BAND-71	71	9mm	50mm	454g
BAND-79	79	9mm	150mm	454g
BAND-89	89	12mm	150mm	454g
BAND-108	108	16mm	200mm	454g

Packaging

Pallet Wrap

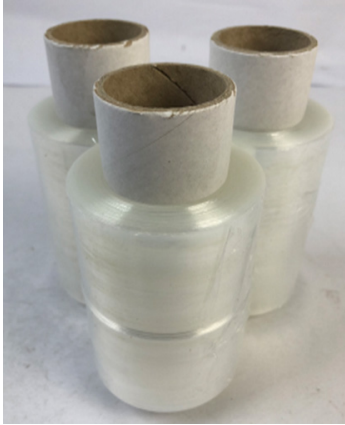
Skillet Wrap						
<p>Cast stretch film produced from a blend of PE film grade polymers designed for stretch wrap applications with production additives and as cast. Stretch film is designed to pack and secure collective products on the pallets as well as large overall dimensions units. This product can be used with manual and automatic packaging and characterised by: high elongation and puncture force, good cling performance.</p>						
						
Code	Width	Length	Thickness	Colour	Box Qty	Unit Of Sale
SHRINK/03	100mm	150m	17mu	Clear	40	Each

String

Horticultural Twine				
<p>Horticultural twine is the ideal twine for use in horticulture, this is widely used for tying up tomato's, peppers & cucumbers. It can also be used in the garden or for other horticultural applications.</p>				
				
Code	Spool Length	Spool Weight	Colour	Unit Of Sale
STRING/12	1200m	6kg	White	Each

Jute Fillis Twine					
Jute Fillis string all your garden needs.					
Code	Description	Spool Length	Weight	Colour	Unit Of Sale
STRING/03	2-Ply	450m	500g	Natural	Each
STRING/04	3-Ply	300m	500g	Natural	Each
STRING/14	3-Ply	150m	250g	Natural	Each
STRING/08	4-Ply	225m	500g	Natural	Each
STRING/09	5-Ply	175m	500g	Natural	Each
STRING/05	3-Ply	60m	110g	Green	x12
STRING/06	3-Ply	300m	500g	Green	Each



Baler Twine		
<p>Baler twine for use with mechanical balers. Can be used for many other tying applications.</p>		
		
Code	Description	Spool length
STRING/01	Blue Baler Twine	1825m

Retail Products

Vitax Retail

Tub & Hanging Basket Feed		
Vitax Tub & Hanging Basket Feed promotes luxuriant foliage and larger, brighter blooms. 1lt of product will make up 200lt of liquid fertiliser.		
Code	Reference	Pack Size
COMP-TUB/11	5HB1	6 x 1lt



Fish Blood & Bone		
Contains the 3 major nutrients essential for strong and healthy growth, including slow release phosphate to boost roots. Encourages rich green foliage and improved ripening of fruit and vegetables.		
Code	Reference	Pack Size
FISH/07	6FB5	2 x 5kg



Liquid Tomato Feed		
A high potash fertiliser for bumper crops of juicy tomatoes. 1lt of product will make up 200lt of liquid fertiliser.		
Code	Reference	Pack Size
TOMATO/05	5LT1	6 X 1lt



Bone Meal		
Slow release organic fertiliser to encourage root development. The nitrogen and phosphate rich formula helps develop healthy roots. Ideal for trees and shrubs.		
Code	Reference	Pack Size
BONE-6BM253	6BM253	3 x 2.5kg



Organic Seaweed		
Vitax Organic Liquid Seaweed stimulates vigorous healthy growth for all plants. 1lt of product makes up to 400lts of liquid fertiliser.		
Code	Reference	Pack Size
5SW500	5SW500	12 x 500ml



Dried Blood		
A fast acting fertiliser rich in nitrogen.		
Code	Reference	Pack Size
BLOOD-6DB96	6DB96	6 x 0.9kg

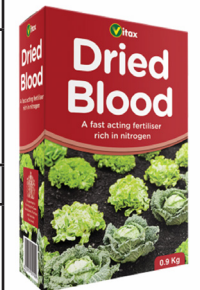

Retail Products

Vitax Retail

Rose Food	
For abundant blooms of brighter roses. Added magnesium and iron to boost health, feeds throughout the growing season.	
Code	Pack Size
6RF253	3 X 2.5kg



Sulphate Of Iron	
Improves the soil conditions for acid loving plants. Can also be used for the control of moss in lawns.	
Code	Pack Size
6SI16	6 X 1kg



Sulphate Of Potash	
Quick acting fertiliser to boost flowering and ripening of fruit.	
Code	Pack Size
6SP126	6 X 1kg



Organic Rose Food	
For strong, healthy growth and more fine quality blooms. Slow release, promotes flowering all season long.	
Code	Pack Size
6ORF96	6 x 0.9kg



Clematis Feed	
More flowers, brighter blooms and strong, healthy growth. Extended release keeps on feeding. Also great for other climbers such as honeysuckle.	
Code	Pack Size
6CF901	6 x 0.9kg



Azalea, Rhododendron & Shrub Fertiliser	
A high quality feed for all ericaceous plants.	
Code	Pack Size
6AZ901	6 x 0.9kg



Acer Fertiliser	
For healthy growth and vibrant foliage in new and established Japanese maple. Organic, one feed lasts all season. The best start when planting new acers.	
Code	Pack Size
6AF901	6 x 0.9kg



Retail Products

Vitax Retail

Yellow Sulphur	
Plant nutrient and soil acidifier. For strong healthy growth.	
Code	Pack Size
5YS225	12 x 225g



PY Bug Killer Concentrate	
Controls aphids, caterpillars and beetles. For use on a range of vegetables and roses	
Use pesticides safely, always read the label.	
Code	Pack size
5CO256	6 x 250ml



Epsom Salts	
A rapid cure for magnesium deficiency in plants.	
Code	Pack Size
6ES126	6 X 1.25kg



PY Bug Killer RTU	
Controls aphids, caterpillars and beetles on a range of vegetables. Controls caterpillars and aphids on roses.	
Use pesticides safely, always read the label.	
Code	Pack Size
5PY750	12 x 750ml



6X Poultry Pellets	
Pelleted, highly concentrated chicken manure. 6X pellets are the ideal organic feed for flowers, lawns, vegetables, pot plants and baskets too. 100% natural.	
Code	Pack Size
76XPCF8	8kg



SBK Brushwood Killer	
SBK brushwood killer is a tough weedkiller for brambles, thistles, nettles and tree stumps. Treats up to 332m2. 1L treats up to 332m2	
Use pesticides safely, always read the label.	
Code	Pack Size
5BKA1	4 x 1lt
5BKA125	12 x 125ml



Retail Products

Slug Control

Slug Gone	
A highly effective barrier against slugs and snails. Slug Gone contains naturally occurring slow release nutrients and is soil association approved.	
Code	Pack Size
5SLG1	12 x 1lt



Moisture Control

Stay Wet	
Stay wet is a granular wetting agent that absorbs and then release moisture back into the growing medium allowing for more efficient use of rain/irrigation water by the plant. Ideal for use in tubs and hanging baskets.	
Code	Pack Size
5SW200	12 x 200g



Slug Rid	
A ready to use bait, containing 10g/kg ferric phosphate. Simply scatter to protect plants, slugs will move away to die without leaving an unsightly trace. Use pesticides safely, always read the label.	
Code	Pack Size
5SR500	12 x 500g
5SR300	12 x 300g



Stay Wet Plus	
Stay Wet Plus is a granular wetting agent for the efficient use of irrigation and rain water, unlike Stay Wet, it will retain and release water over a period of 4 months, making it ideal for areas susceptible to drought. Ideal for use in tubs and hanging baskets.	
Code	Pack Size
5SW201	12 x 200g



Copper Slug Tape - 4m	
Stops slugs and snails in their tracks. The adhesive copper barrier tape protects pots, tubs & greenhouse staging.	
Code	Pack Size
5CS1	12 x 4m x 23mm



Organic Rooting Powder	
Organic rooting powder stimulates rooting making it the ideal way to start rooted cuttings. Suitable for edible and ornamental crops, use with soft, medium and hardwood cuttings.	
Code	Pack Size
5RP50	12 x 50g



Retail Products

Chempak

High Nitrogen Feed - Formula 2		
<p>Formula 2 is an early season feed to boost plant growth. Ideal as an all year round feed for green vegetables. Makes up to 1600lts of liquid feed.</p>		
Code	NPK Ratio	Pack Size
CHEMP/03	25-15-15	12 x 800g

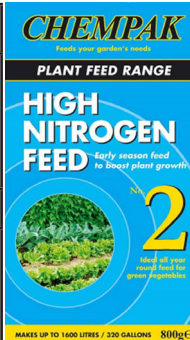

Low Nitrogen Feed - Formula 8		
<p>Ideal feed for established plants. Formula 8 allows for mature, firm growth. Makes up to 1600lts of liquid feed.</p>		
Code	NPK Ratio	Pack Size
CHEMP/06	12.5-25-25	12 x 800g



Fully Balanced Feed - Formula 3		
<p>Year round balanced feed for all plants. Ideal general purpose feed. Makes up to 1600lts of liquid feed.</p>		
Code	NPK Ratio	Pack Size
CHEMP/04	20-20-20	12 x 800g

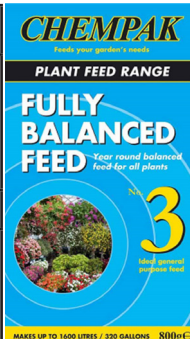

Potting Base with Soluwet Wetting Agent		
<p>Converts peat into potting compost. For re-potting and potting on plants and shrubs, for hanging baskets and containers. Contains Soluwet wetting agent.</p>		
Code	NPK Ratio	Pack Size
CHEMP/07	7.5-3.6-5.2	12 x 800g

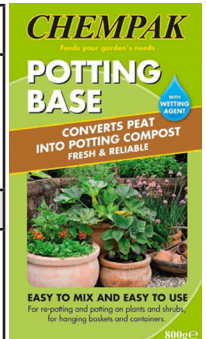

High Potash Feed - Formula 4		
<p>For tomatoes, flowers and vegetables. Formula 4 offers better blooms and bumper crops. Makes up to 1600lts of liquid feed.</p>		
Code	NPK Ratio	Pack Size
CHEMP/05	15-15-30	12 x 800g

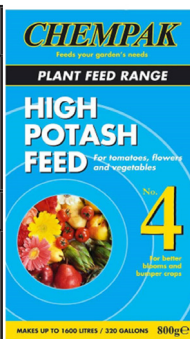

Multipurpose Base with Wetting Agent		
<p>Converts peat into multipurpose compost. For use with seed trays, houseplants, hanging baskets and containers.</p>		
Code	NPK Ratio	Pack Size
CHEMP/01	3.2-3.4-3.6	12 x 800g

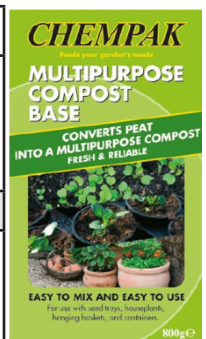

Retail Products

Soluble Tomato Food		
A high quality, soluble tomato fertiliser suitable for use on all tomatoes, cucumbers, peppers, courgettes, aubergines and soft fruit.		
Code	NPK Ratio	Pack Size
CHEMP/08	11-9-30+2.5MgO	12 x 1kg)



Sequestered Iron	
Quick acting, easy to scatter tonic for acid loving plants. Corrects and prevents leaf yellowing and boosts plant health.	
Code	Pack Size
CHEMP/11	10 x 250g



Chempak Sulphur	
Provides ericaceous plants with the ideal soil for healthy growth. Contains Sulphur, an important trace element that gives plants the ideal soil base for healthy growth.	
Code	Pack Size
CHEMP/09	10 x 750g



Vegetable Fertiliser		
An all-purpose base and top dressing with four distinct phases of release of the most important plant food; nitrogen, released in a steady flow over a period of time, in conjunction with phosphates and potash providing your plants with all the nutrients they need .		
Code	NPK Ratio	Pack Size
CHEMP/12	15-3-20	12 x 1kg

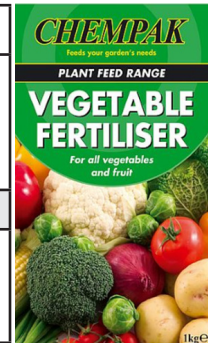

Chempak Magnesium	
Specialist plant food to put the colour back into flowers and vegetable greenery. Improves uptake of nutrients and greens up yellowing plants.	
Code	Pack Size
CHEMP/10	10 x 750g



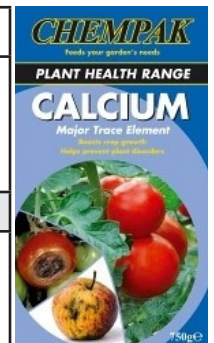

Chempak Calcium		
Boosts crop growth and helps to prevent disorders such as blossom end rot, lettuce tip burn and apple bitter pit." Add code CHEMP/02 and pack size "10 x 750g.		
Code	NPK Ratio	Pack Size
CHEMP/02	15-6-12	10 x 750g



Retail Products

Rock Salt

Brown Rock Salt		
<p>Our pure brown rock salt is ideal for de-icing roads, driveways, car parks and pathways. This product is not blended or mixed with any sand or substitute and conforms to BS3244.</p>		
Code	Unit Of Sale	
SALT-BR/01	25kg	Handy Bag
SALT-BR/02	800kg	Bulk Bag
SALT-BR/03	Metric tonne	Loose

White De-Icing Salt		
<p>Our white salt is ideal for schools, hospitals, offices and other places of work for footpaths and entrance ways.</p> <p>It is a cleaner alternative to the brown rock salt.</p>		
Code	Unit Of Sale	
SALT-WDI/01	25kg	Handy Bag
SALT-WDI/02	800kg	Bulk Bag
SALT-WDI/03	Metric tonne	Loose

Winter Salt Storage

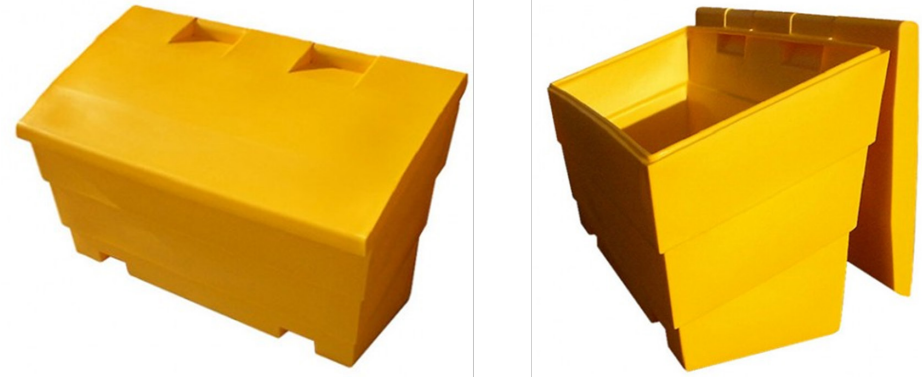
Grit Bins					
<p>Our Grit Bins are made from UV resistant and durable polyethylene that makes a rugged and water tight container for a wide range of contents.</p> <p>These bins can also be branded with a company logo in the form of a sticker.</p> <ul style="list-style-type: none"> • Available in : Yellow, Black, Green, Blue, Red, Grey & Stone Effect 					
					
Code	Width	Depth	Height (At the Back)	Volume	Colour
BIN/04	590mm	420mm	450mm	2 cu ft / 50lt	Yellow
BIN/02	885mm	615mm	670mm	6 cu ft / 175lt	Yellow
BIN/01	1220mm	650mm	750mm	12 cu ft / 350lt	Yellow

Winter Products

Deicers

Surefoot

A high performance liquid deicer for use on footpaths and public thorough-fares, any situation where ice poses a risk to pedestrians and users.

As Surefoot is a liquid deicer it starts melting ice immediately after application; unlike solid deicers which need to dissolve in water before becoming active. It is supplied in easy to handle drums which stack neatly and safely for simple storage. Any unused deicer can be poured back into the drum and stored indefinitely.

- Simple to handle: Surefoot is simple to handle and easy to store
- Non - Corrosive: Unlike salt, Surefoot is effectively non-corrosive
- Lower Temperatures: Remains active at temperatures as low as -50°C
- Fast Acting: Surefoot rapidly penetrates the snowpack and ice
- No Unwanted Residue: Surefoot doesn't leave a gritty residue.
- Long Lasting: Will prevent frost formation for 24-48 hours



Code	Application Rate	Unit Of Sale
SURE/01	15ml - 75mm / m2	1lt
SURE/02	15ml - 75mm / m2	10lt
SURE/03	15ml - 75mm / m2	1000lt IBC

Ice Melt

A fast acting, free flowing and easy to use granular compound that eliminates ice and snow without any harmful effects.

Unlike rock salt, Ice Melt will not leave scratch markings or staining to flooring and will still melt ice in temperatures exceeding -11°C

Ice Melt is suitable for use in Shopping Centres, Car Parks, Pedestrian Bridges, Pathways, Driveways, Trading Estates and other public areas.

- Plant based nutrients making it a more environmentally friendly product
- Non Corrosive
- Non Toxic
- Biodegradable
- No stains or residue
- Prevents refreezing for up to 24hrs



Code	Unit Of Sale
ICEM	20kg

Winter Products

Salt Spreaders

Earthway EV-N-SPRED®2040Pi +

The Earthway Ev-n-Spred 2040 pi pedestrian broadcast spreader boasts a wide range of professional features in a light weight and robust package. The 2040 pi has been specifically designed for spreading ice melt, rock salt, dry sand and other high-volume application products. Pneumatic tyres means that the Ev-n-Spred 2040Pi salt spreader will be comfortable to use and outlast the competition even in the most harsh and icy of conditions.

- 30lt capacity
- 5 year warranty
- Precise spread pattern
- Allows adjustment for different products
- Proven technology ideal for rock salt
- EV-N-SPREAD High Output Drop System
- No 'sticky' cables to rust with salt
- Ideal for snow and icy conditions



Code	Unit Of Sale
SPREADER/06	Each

Chelwood Aluminium Snow Shovel

Without any doubt this is the best snow shovel available. The stainless steel leading edge improves the effectiveness of the front edge and prolongs the life of the snow shovel" This leaves safer surfaces, requiring less salt and reducing time and money in making safer walkways.



Code	Supplier Reference	Head Size
SHOVEL/07	45 SS-L	45cm x 45cm

Bulldog Snow Shovel

A large capacity plastic head with metal strip designed to chip away at ice and compacted snow. An essential tool in the cold winter weather.

- Metal edging strip
- Heavy duty plastic ribbed head
- 42" Ash shaft with plastic "D" grip
- Also has equestrian use



Code	Supplier Reference	Head Size
SHOVEL/03	SNOW1	14" x 18" (360 x 460mm)

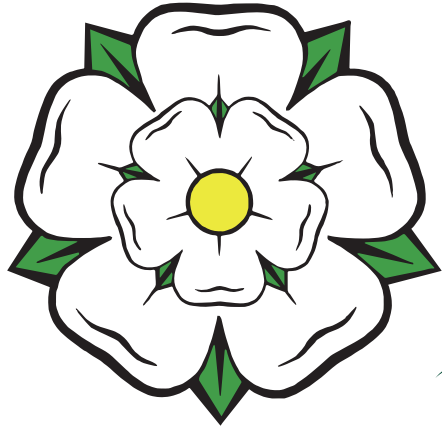

East Riding Horticulture Ltd

SCOTLAND OFFICE

11 Humble Holdings
Kirknewton
Midlothian
Scotland
EH27 8DS

01506 880090

HEAD OFFICE

Glebe Farm Cottage
Sutton Upon Derwent
York
YO41 4BY

01904 608157

Email

sales@erh-ltd.co.uk

Website

www.eastridinghorticulture.co.uk